

# DL205 - Great Fit For Applications That Need Counting and/or Pulse Output

## Here's why

The DL205 PLC family offers two different modules for applications that require counting and pulse output features. Read on to see which module best fits your application needs

### The D2-CTRINT offers:

One 5 kHz up/down counter or quadrature input

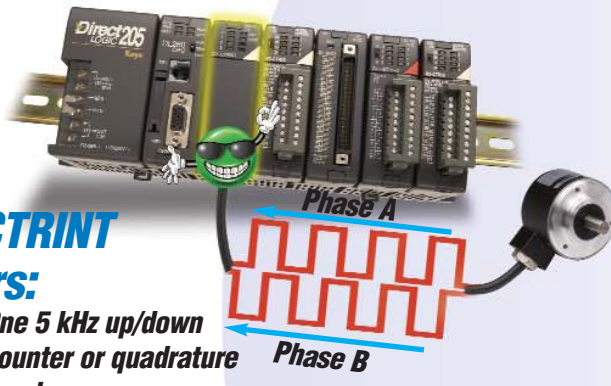

### Or two 5 kHz counters

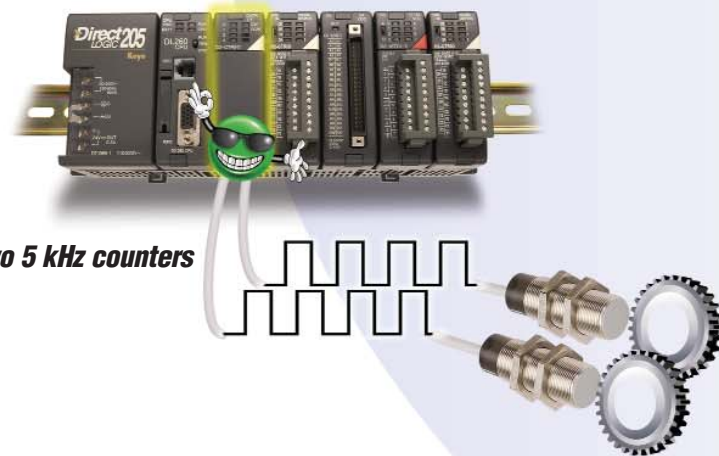

### Or one 5 kHz pulse output to a stepper or servo drive

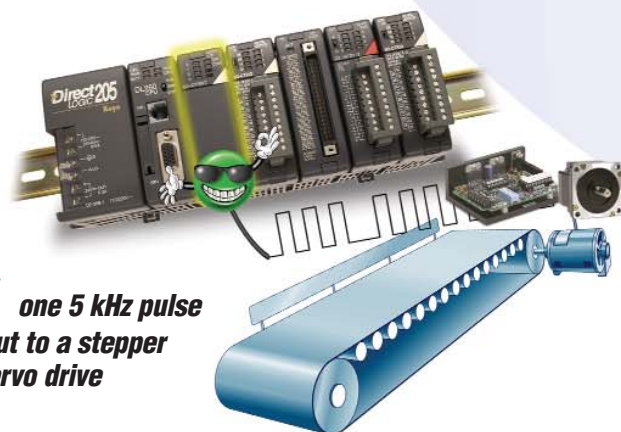

## Two practical alternatives

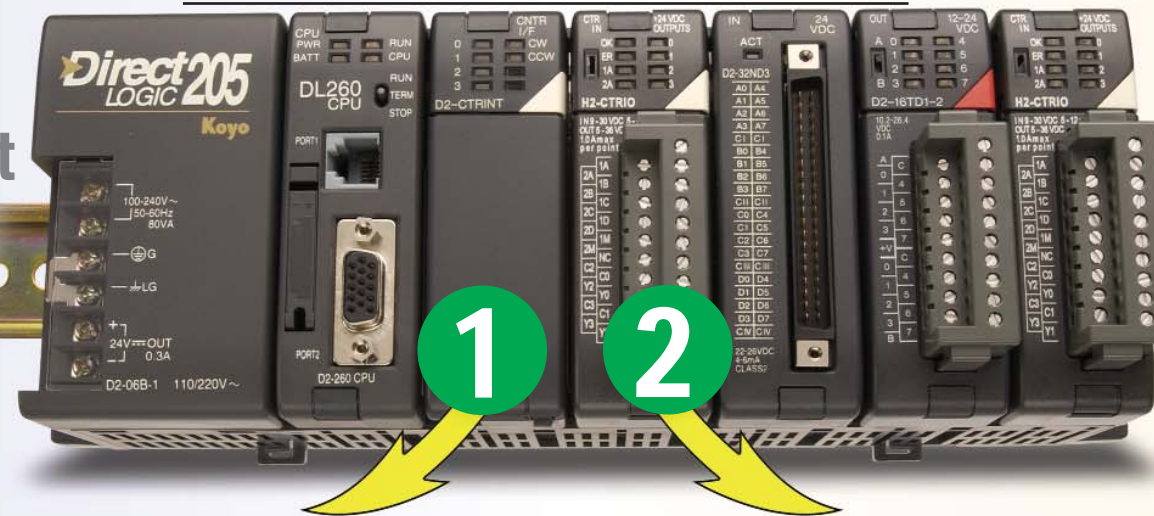

### Counting or pulse output for \$85.00

#### Simple but sweet!

The DL205 counter interface module (D2-CTRINT) is priced at \$85.00, making it the best way to perform basic counting or pulse output with a DL205 system. Basically, this is a discrete I/O module that counts or generates pulse and has been designed into the DL205 CPUs, hence the name Counter Interface. The D2-CTRINT can be configured to perform any one of the following operations:

- Quadrature encoder input for clockwise and counter-clockwise position
- Two, 5 kHz high-speed counters
- Programmable pulse output with external interrupts and separate acceleration and deceleration profiles for positioning and velocity control (5K pulses max per second)
- Four external interrupt inputs for immediate responses to tasks
- Pulse catch feature allowing the CPU to read four inputs, each having a pulse width as small as 5 μsec
- Programmable filters for reading up to 4 input signals to ensure input signal integrity

**Limitations:** For \$85.00 there are some limitations. Most often, this module can be used for only one of the functions listed. It cannot use the pulse output and counter features together for closed loop control. Some features are not available when used with certain DL205 CPUs. Only one D2-CTRINT module can be used per system and it must be placed in the I/O slot next to the CPU. All programming is done through RLL logic.

### High-performance counting and pulse output with fill-in-the-blank software

The DL205 high-speed counter module (H2-CTRIO) is priced at \$289.00 and is our high-performance, high-feature offering for counting and pulse output. This module comes with a software utility that makes configuring the module as simple as clicking on features and filling in the blanks. No ladder logic is needed to operate this as a counter module, although you may use some RLL to coordinate your PLC program.

#### Key features include:

- Two quadrature encoder inputs or four 100 kHz high-speed counters (32-bit count range for +/-2.1 billion counts)
- Two programmable pulse outputs support Trapezoid, Velocity S-curve, or program controlled Dynamic Positioning, or four discrete isolated outputs for responding to counter presets (128 presets)
- Pulse catch feature (allows the module to read four inputs, each having a pulse width as small as 5 μsec)
- Programmable filters for reading up to four input signals to ensure input signal integrity
- Can use multiple modules in local DL205 base (any slot except slot 0)

**Limitations:** All input functions or all output functions can not be done simultaneously. Counting and pulse out can be done simultaneously, however the module does not internally support closed loop control.

## CHECK OUT OUR PRICES

Feature	AutomationDirect H2-CITRIO	Allen-Bradley SLC 500 1746-HSCE	Allen-Bradley SLC 500 1746-HSCE2
Inputs	Two quadrature or four up counters 100 kHz max	One quadrature or two up counters 50 kHz max	Two quadrature or four up counters 1 MHz max
Minimum Input Pulse Width	5 μsec	10 μsec	475 ns
Count Range	32-bit +/-2.1 billion counts (31-bits plus sign bit)	16-bit +/-32,767 count (15-bit plus sign bit)	24-bit +/-8,388,607 (23-bit plus sign bit)
Number of Programmable Presets	128 presets per table	24 presets per table	N/A
Outputs	Four isolated outputs; sink or sourcing configurable	Four non-isolated sinking only outputs	Four non-isolated sourcing only outputs
Pulse Outputs	Two channels 25 kHz max	None	None
Price*	\$289	\$660	\$1,067

\*All prices are U.S. published prices. Prices and specifications may vary by dealer and configuration. AutomationDirect prices are from October 2007 Price List. Allen-Bradley prices are from <http://shop.rockwellautomation.com> 7/20/07.

### The H2-CTRIO offers:

Two 100 kHz up/down counters or quadrature inputs

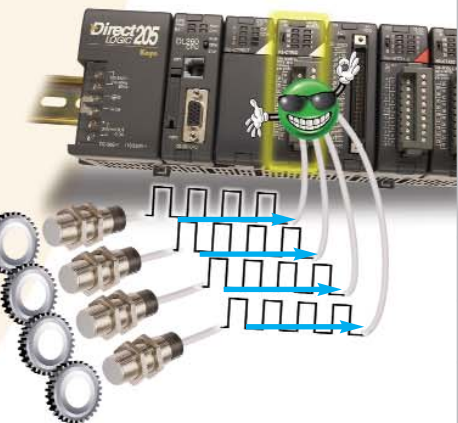
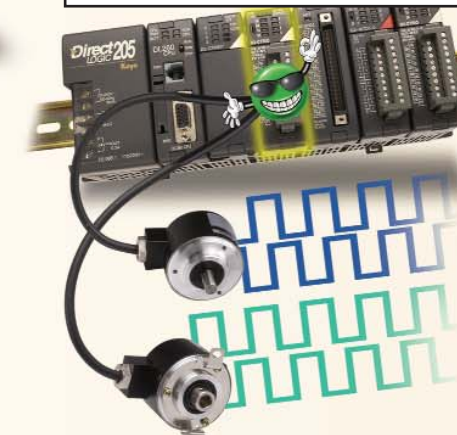

### Or four 100 kHz counters

## AND

Two 25 kHz pulse outputs for stepper or servo drives

### Or four built-in discrete isolated outputs to respond to counter presets

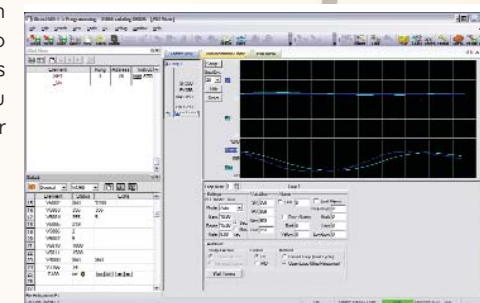

Fill-in-the-blank configuration of counters and pulse outputs saves time.



### Pulse out

