



To download fullsize color .pdf Ziplink Wiring Diagrams go to [www.Automationdirect.com](http://www.Automationdirect.com) website

**ZIP LINK™**  
Automationdirect.com  
800-633-0405

## LED Connector Module ZL-CM16L24 Cables and PLC I/O Modules

### Mounting Orientation:

PLC Type	Cable Type	PLC I/O Module Type	Connector Module Type
DL205	ZL-2CBL2L	D2-16ND3-2	ZL-CM16L24
DL305	ZL-3CBL2L	D3-16NE3	ZL-CM16L24
DL405	ZL-4CBL2	D4-16ND2	ZL-CM16L24
DL405	ZL-4CBL2	D4-16ND2F	ZL-CM16L24
DL405	ZL-4CBL2	D4-16NE3	ZL-CM16L24
DL05/06	ZL-CBL056L	D0-16ND3	ZL-CM16L24

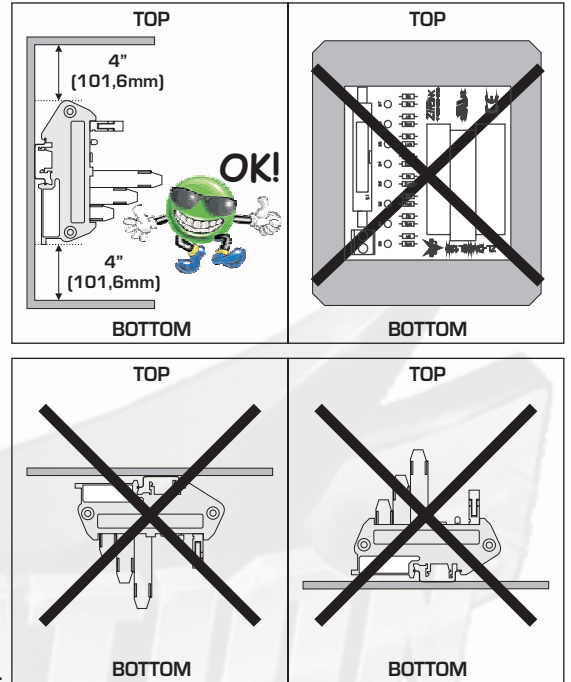

**WARNING : WIRE ONLY ACCORDING TO WIRING DIAGRAMS SHOWN BELOW TO AVOID CAUSING DAMAGE TO THE PLC OR CONNECTOR MODULE. MATCH THE CORRECT COMBINATION OF CABLE, PLC I/O MODULE, AND CONNECTOR MODULE AS SHOWN.**

### Connection Example

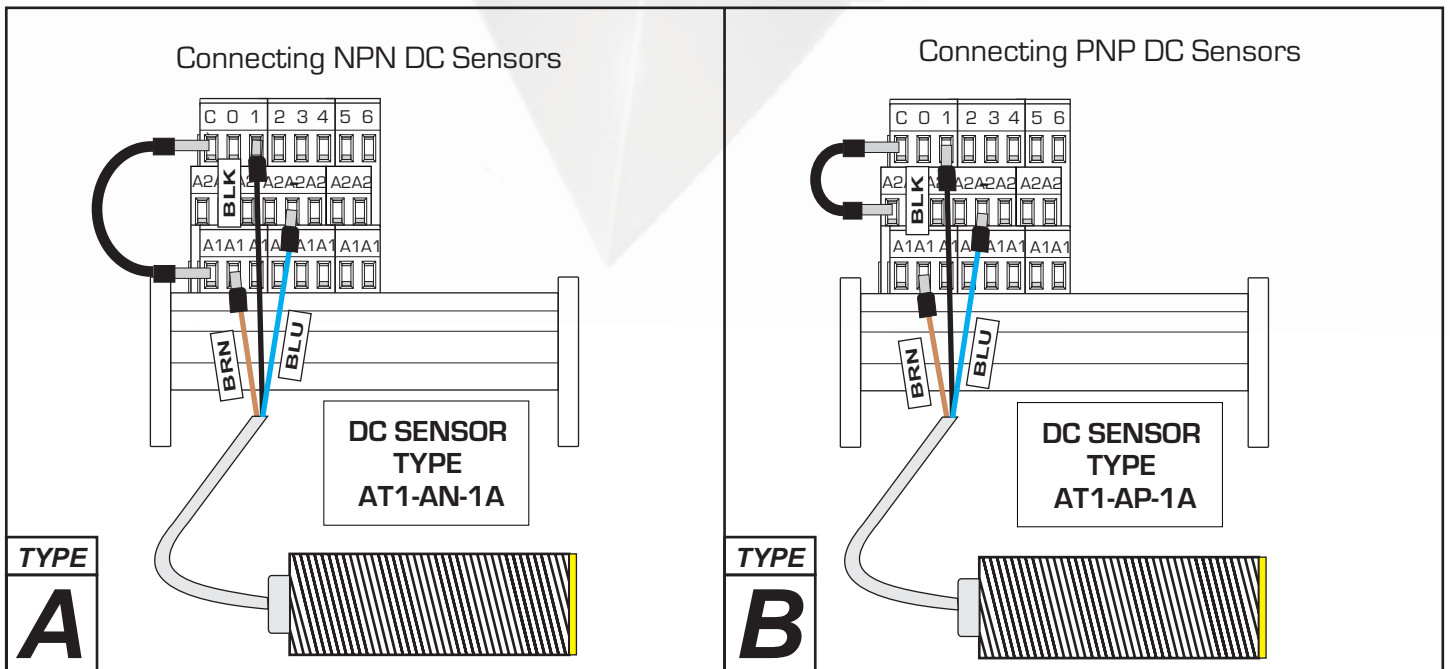

Connecting DC Switches with A2 (or A1) Common

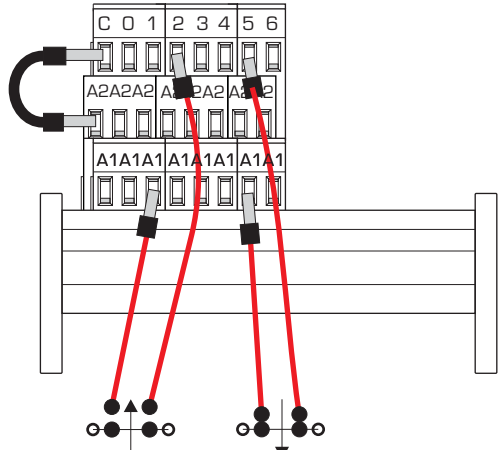

TYPE  
**C**

Sensor switch normally open      Sensor switch normally closed

Connecting DC Switches with A2 (or A1) Common

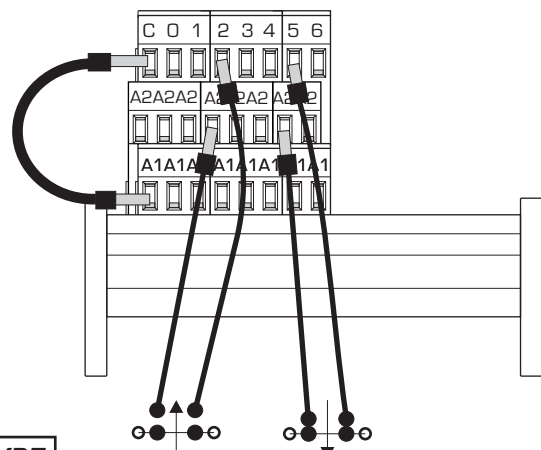

TYPE  
**D**

Sensor switch normally open      Sensor switch normally closed

Connecting AC Sensor with A1 (or A2) Common

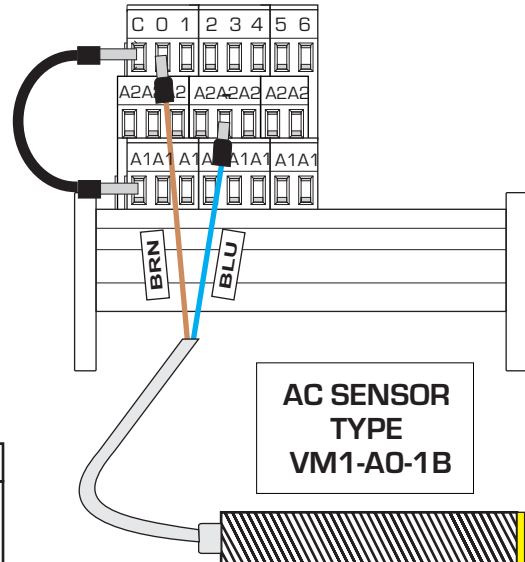

TYPE  
**E**

AC SENSOR TYPE VM1-A0-1B

Connecting AC Sensor with A1 (or A2) Common

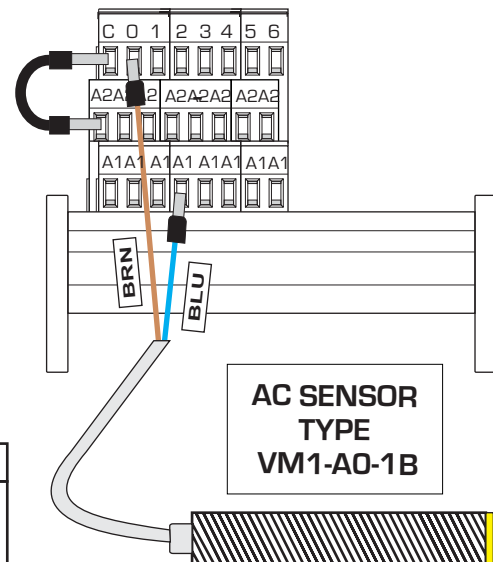

TYPE  
**F**

AC SENSOR TYPE VM1-A0-1B

Connecting AC Switches with A2 (or A1) Common

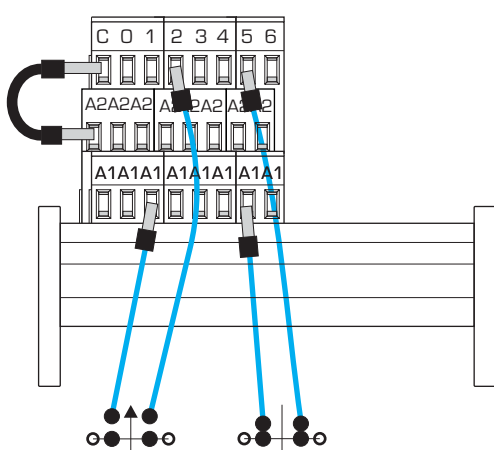

TYPE  
**G**

Sensor switch normally open      Sensor switch normally closed

Connecting AC Switches with A2 (or A1) Common

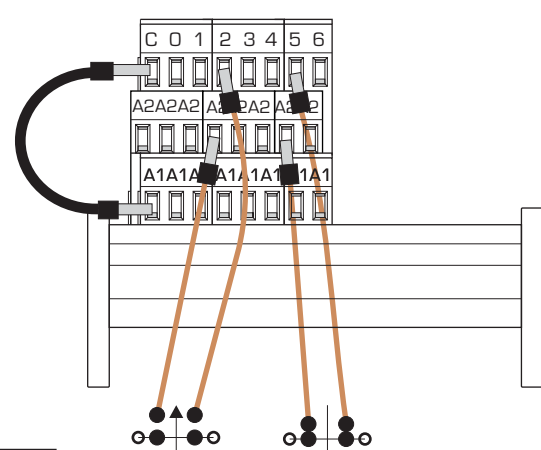

TYPE  
**H**

Sensor switch normally open      Sensor switch normally closed

# Wiring Diagram: Power Supply and Cable

PLC DL 205 Type D2-16ND3-2  
DC Input I/O Module

Cable ZL-2CBL2L

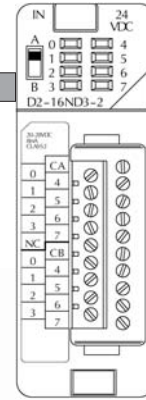

**Warning :**  
It is recommended to install a 2 Amp fast blow fuse in series with the power supply as an extra safety measure.  
Use a fuse terminal block such as a DINnector DN-F10 or DN-F10L

ZL-CM16L24

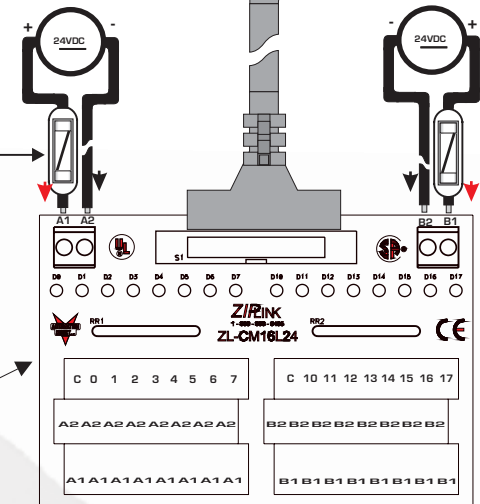

COMPATIBLE WITH CONNECTION:

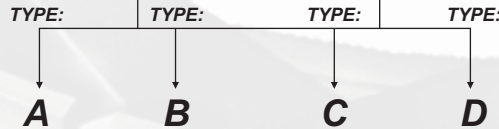

- I/O Module Input: Octal Address 0 corresponds to LED 0
- I/O Module Input: Octal Address 1 corresponds to LED 1
- I/O Module Input: Octal Address 2 corresponds to LED 2
- I/O Module Input: Octal Address 3 corresponds to LED 3
- I/O Module Input: Octal Address 4 corresponds to LED 4
- I/O Module Input: Octal Address 5 corresponds to LED 5
- I/O Module Input: Octal Address 6 corresponds to LED 6
- I/O Module Input: Octal Address 7 corresponds to LED 7
- I/O Module Input: Octal Address 10 corresponds to LED 10
- I/O Module Input: Octal Address 11 corresponds to LED 11
- I/O Module Input: Octal Address 12 corresponds to LED 12
- I/O Module Input: Octal Address 13 corresponds to LED 13
- I/O Module Input: Octal Address 14 corresponds to LED 14
- I/O Module Input: Octal Address 15 corresponds to LED 15
- I/O Module Input: Octal Address 16 corresponds to LED 16
- I/O Module Input: Octal Address 17 corresponds to LED 17

# Wiring Diagram: Power Supply and Cable

PLC DL 305 Type D3-16NE3  
AC/DC Input I/O Module

Cable ZL-3CBL2L

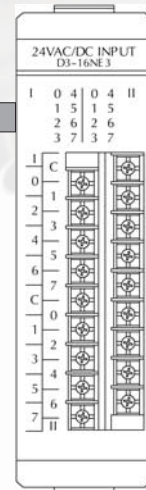

**Warning :**  
It is recommended to install a 2 Amp fast blow fuse in series with the power supply as an extra safety measure.  
Use a fuse terminal block such as a DINnector DN-F10 or DN-F10L

ZL-CM16L24

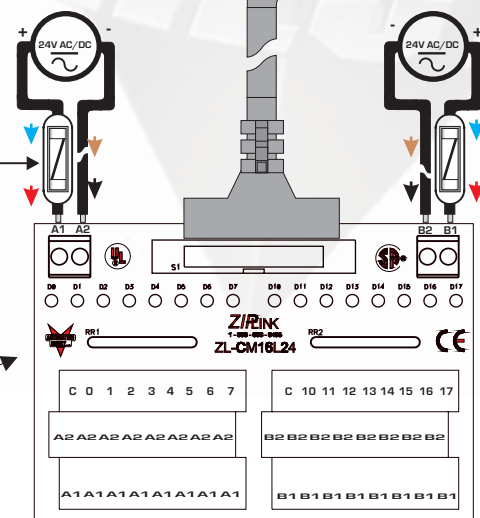

COMPATIBLE WITH CONNECTION:

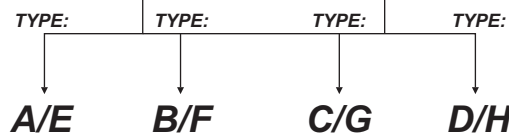

- I/O Module Input: Octal Address 0 corresponds to LED 0
- I/O Module Input: Octal Address 1 corresponds to LED 1
- I/O Module Input: Octal Address 2 corresponds to LED 2
- I/O Module Input: Octal Address 3 corresponds to LED 3
- I/O Module Input: Octal Address 4 corresponds to LED 4
- I/O Module Input: Octal Address 5 corresponds to LED 5
- I/O Module Input: Octal Address 6 corresponds to LED 6
- I/O Module Input: Octal Address 7 corresponds to LED 7
- I/O Module Input: Octal Address 10 corresponds to LED 10
- I/O Module Input: Octal Address 11 corresponds to LED 11
- I/O Module Input: Octal Address 12 corresponds to LED 12
- I/O Module Input: Octal Address 13 corresponds to LED 13
- I/O Module Input: Octal Address 14 corresponds to LED 14
- I/O Module Input: Octal Address 15 corresponds to LED 15
- I/O Module Input: Octal Address 16 corresponds to LED 16
- I/O Module Input: Octal Address 17 corresponds to LED 17

# Wiring Diagram: Power Supply and Cable

PLC DL 405 Type D4-16ND2  
DC Input I/O Module

Cable ZL-4CBL2

**Warning :**  
It is recommended to install a 2 Amp fast blow fuse in series with the power supply as an extra safety measure.  
Use a fuse terminal block such as a DINnector DN-F10 or DN-F10L

ZL-CM16L24

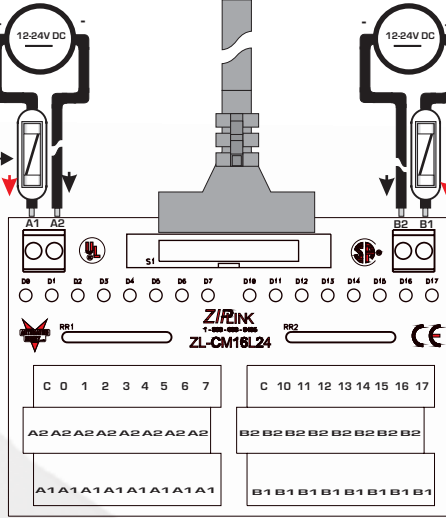

COMPATIBLE WITH CONNECTION:

TYPE:

A

TYPE:

D

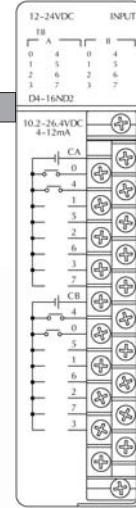

- I/O Module Input Octal Address 0 corresponds to LED 0
- I/O Module Input Octal Address 1 corresponds to LED 1
- I/O Module Input Octal Address 2 corresponds to LED 2
- I/O Module Input Octal Address 3 corresponds to LED 3
- I/O Module Input Octal Address 4 corresponds to LED 4
- I/O Module Input Octal Address 5 corresponds to LED 5
- I/O Module Input Octal Address 6 corresponds to LED 6
- I/O Module Input Octal Address 7 corresponds to LED 7
- I/O Module Input Octal Address 10 corresponds to LED 10
- I/O Module Input Octal Address 11 corresponds to LED 11
- I/O Module Input Octal Address 12 corresponds to LED 12
- I/O Module Input Octal Address 13 corresponds to LED 13
- I/O Module Input Octal Address 14 corresponds to LED 14
- I/O Module Input Octal Address 15 corresponds to LED 15
- I/O Module Input Octal Address 16 corresponds to LED 16
- I/O Module Input Octal Address 17 corresponds to LED 17

# Wiring Diagram: Power Supply and Cable

PLC DL 405 Type D4-16ND2F  
DC Input I/O Module

Cable ZL-4CBL2

**Warning :**  
It is recommended to install a 2 Amp fast blow fuse in series with the power supply as an extra safety measure.  
Use a fuse terminal block such as a DINnector DN-F10 or DN-F10L

ZL-CM16L24

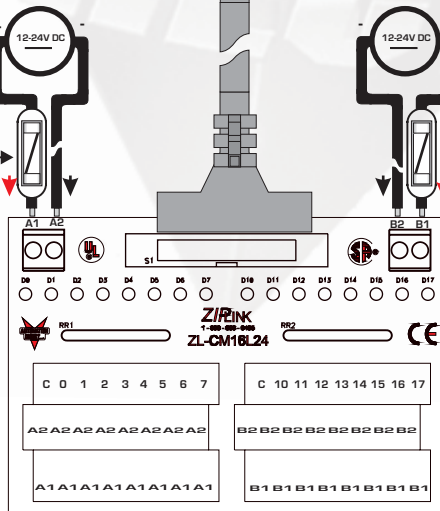

COMPATIBLE WITH CONNECTION:

TYPE:

A

TYPE:

D

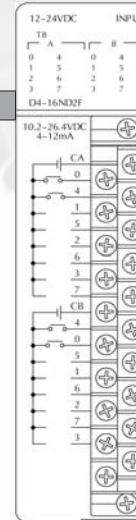

- I/O Module Input Octal Address 0 corresponds to LED 0
- I/O Module Input Octal Address 1 corresponds to LED 1
- I/O Module Input Octal Address 2 corresponds to LED 2
- I/O Module Input Octal Address 3 corresponds to LED 3
- I/O Module Input Octal Address 4 corresponds to LED 4
- I/O Module Input Octal Address 5 corresponds to LED 5
- I/O Module Input Octal Address 6 corresponds to LED 6
- I/O Module Input Octal Address 7 corresponds to LED 7
- I/O Module Input Octal Address 10 corresponds to LED 10
- I/O Module Input Octal Address 11 corresponds to LED 11
- I/O Module Input Octal Address 12 corresponds to LED 12
- I/O Module Input Octal Address 13 corresponds to LED 13
- I/O Module Input Octal Address 14 corresponds to LED 14
- I/O Module Input Octal Address 15 corresponds to LED 15
- I/O Module Input Octal Address 16 corresponds to LED 16
- I/O Module Input Octal Address 17 corresponds to LED 17

# Wiring Diagram: Power Supply and Cable

PLC DL 405 Type D4-16NE3  
AC/DC Input I/O Module

Cable ZL-4CBL2

**Warning :**  
It is recommended to install a 2 Amp fast blow fuse in series with the power supply as an extra safety measure.  
Use a fuse terminal block such as a DINnector DN-F10 or DN-F10L

ZL-CM16L24

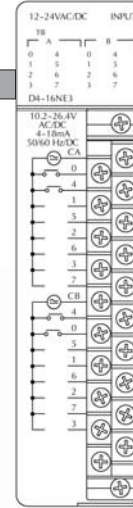
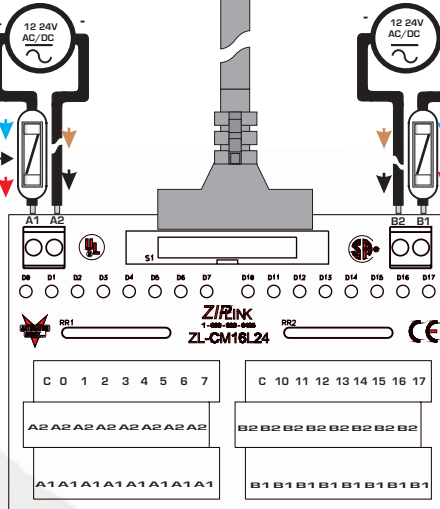

COMPATIBLE WITH CONNECTION:



- I/O Module Input Octal Address 0 corresponds to LED 0
- I/O Module Input Octal Address 1 corresponds to LED 1
- I/O Module Input Octal Address 2 corresponds to LED 2
- I/O Module Input Octal Address 3 corresponds to LED 3
- I/O Module Input Octal Address 4 corresponds to LED 4
- I/O Module Input Octal Address 5 corresponds to LED 5
- I/O Module Input Octal Address 6 corresponds to LED 6
- I/O Module Input Octal Address 7 corresponds to LED 7
- I/O Module Input Octal Address 10 corresponds to LED 10
- I/O Module Input Octal Address 11 corresponds to LED 11
- I/O Module Input Octal Address 12 corresponds to LED 12
- I/O Module Input Octal Address 13 corresponds to LED 13
- I/O Module Input Octal Address 14 corresponds to LED 14
- I/O Module Input Octal Address 15 corresponds to LED 15
- I/O Module Input Octal Address 16 corresponds to LED 16
- I/O Module Input Octal Address 17 corresponds to LED 17

# Wiring Diagram: Power Supply and Cable

PLC DL05/06 Type D0-16ND3  
DC Input I/O Module

Cable ZL-CBL056L

**Warning :**  
It is recommended to install a 2 Amp fast blow fuse in series with the power supply as an extra safety measure.  
Use a fuse terminal block such as a DINnector DN-F10 or DN-F10L

ZL-CM16L24

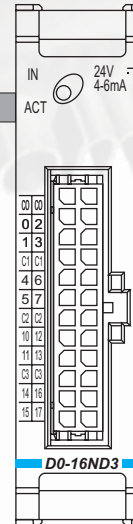
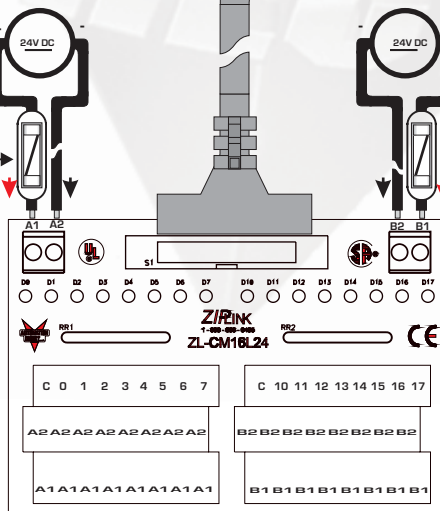

COMPATIBLE WITH CONNECTION:

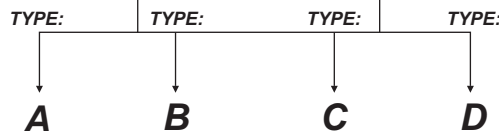

- I/O Module Input Octal Address 0 corresponds to LED 0
- I/O Module Input Octal Address 1 corresponds to LED 1
- I/O Module Input Octal Address 2 corresponds to LED 2
- I/O Module Input Octal Address 3 corresponds to LED 3
- I/O Module Input Octal Address 4 corresponds to LED 4
- I/O Module Input Octal Address 5 corresponds to LED 5
- I/O Module Input Octal Address 6 corresponds to LED 6
- I/O Module Input Octal Address 7 corresponds to LED 7
- I/O Module Input Octal Address 10 corresponds to LED 10
- I/O Module Input Octal Address 11 corresponds to LED 11
- I/O Module Input Octal Address 12 corresponds to LED 12
- I/O Module Input Octal Address 13 corresponds to LED 13
- I/O Module Input Octal Address 14 corresponds to LED 14
- I/O Module Input Octal Address 15 corresponds to LED 15
- I/O Module Input Octal Address 16 corresponds to LED 16
- I/O Module Input Octal Address 17 corresponds to LED 17

<b>LED Modules</b>	
<b>Part Number</b>	<b>ZL-CM16L24</b>
<b>Description</b>	16 point I/O connector module with 16 LEDs,24V, 24 pin IDC
<b>Approvals</b>	UL/CUL/CE
<b>Voltage Rating</b>	0-30 VAC/DC
<b>Peak Voltage</b>	70V
<b>Maximum Current (per Circuit)</b>	1A
<b>Maximum Current (per Module)</b>	16A
<b>Indicator Circuit Current</b>	2mA
<b># of Terminals per Device Common</b>	18
<b>Operating Temperature Range</b>	0°C to +50°C
<b>Operation Voltage</b>	5-26VDC
<b>Max Voltage</b>	30VDC
<b>Max Current per Channel</b>	500mA
<b>Current Nominal per Channel</b>	8-18mA
<b>Wire Range (Rated Cross Section)</b>	14-22 AWG (0.2-2.5mm <sup>2</sup> )
<b>Wire Strip Length</b>	0.32 (8mm)
<b>Terminal Block Contacts</b>	Copper alloy, tin-lead plating
<b>Dimensions (L x W x H)</b>	4.37"(111mm) x2.99"(76mm) x 3.66"(93mm)