

9630NP



Straight Blade Plug.

Product Specifications

Product Type	Plug.
Device Type	Straight Body.
Amperage	30A
Voltage	250V
Poles and Wires	2 Pole, 3 Wire.
Color	Gray
NEMA #	6-30P
Face/Terminal Assembly	Impact Modified Nylon.
Cord Grip	Impact Modified Nylon.
Cover (Housing)	High-Impact, V-O Valox.
Terminal Cover	Clear Polycarbonate.
Plug Blades	Brass.
Terminal Clamp Nut	Zinc-Plated Steel.
Terminal Screw	#8-32 Brass, Silver Finish on Neutral Screw, Green Finish on Grounding Screw.
Assembly Screws	Zinc-Plated Steel.
Dielectric Voltage	Withstands 1500V per UL498.

Maximum Working Voltage	250V AC or DC
Current Interrupting	Certified for current interrupting at full rated current.
Temperature Rise	Less than 30 deg C temperature rise at full rated current after 50 cycles overload at 150% rated current for either AC or DC applications per UL498.
Terminal Identification	Brass-Hot; Green-Grounding; Silver-Neutral.
Terminal Accommodation	#18-#10 AWG Flexible Cord.
Product Identification	Ratings are a permanent part of the device.
Cord Accommodation	Round portable service cords in accordance with device ratings as defined in UL standard 62, CSA C22.2 No.49.
Cord Grip Range	.245"-.655" (6.2-16.6)
Flammability	HB or Better per UL94.
Operating Temperature	Maximum Continuous 60 deg C, Minimum -40 deg C (w/o impact).
UL Standard	UL Listed to Standard 498 (Attachment Plugs and Receptacles).
CSA Standard	Certified to CSA Standard C22.2 No. 42M1984 (General Use Receptacles).
UL Listing	UL Listed File #E1381- Guide #AXUT.
CSA Certification	CSA Certified File #LR16215- Guide 20T2.
Federal Specification	Federal Specification WC596 (where applicable).
Complies with:	NEMA Standards WD-1, WD-6.
Overseas Approval	NOM, CE.
Catalog Page	Click here for catalog page

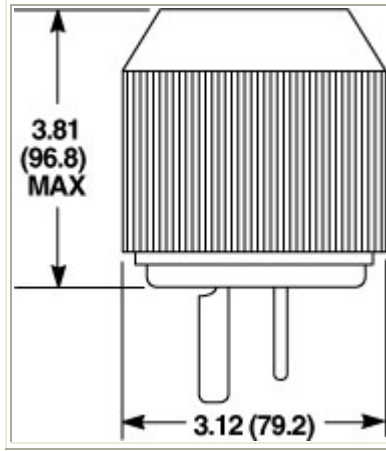

BRYANT®