

70930FR



Locking Receptacle.

Product Specifications

Product Style	Standard Locking.
Amperage	30A
Device Type	Flush Receptacle.
Poles and Wires	2 Pole, 3 Wire.
Voltage	600V AC
Product Variation	Standard.
Color	Black.
Configuration Type	L9-30
Base	Reinforced Thermoplastic Polyester.
Face	Nylon.
Terminals	0.40" (1.0) Copper Alloy.
Terminal Clamp	0.40" (1.0) Copper Alloy.
Ground Contact	0.40" (1.0) Copper Alloy.
Ground Shunt	.015" (.3) Copper Alloy.
Mounting Strap	.050" (1.3) Steel (Nickel-Plated).
Back Plate	.040" (1.0) Plated Copper Alloy.
Terminal Screws	#10 Bronze.
Self Ground Clip	Stainless Steel.
Mounting Screws	Plated Steel.
Dielectric Voltage	Withstands 3500V per UL498.

Max Working Voltage	600V AC or 250V DC.
Current Interrupting	Certified for current interrupting at full rated current.
Temperature Rise	Maximum 30 deg C temperature rise at full rated current after 50 cycles of overload at 150% rated current for either AC or DC applications per UL498
Terminal Identification	(X, Y Z Brass Hot) (G, Green, Grounding) (W, Silver, Neutral).
Terminal Accommodation	#14-#8 AWG solid or stranded copper wire.
Product Identification	Ratings and NEMA identification are permanently marked on device.
Flammability	UL 94 V2 Minimum.
Operating Temperatures	-40 deg C to 85 deg C (continuous w/o impact).
UL Standard	UL Listed to Standard 498 (Attachment Plug and Receptacles).
CSA Standard	Certified to CSA Standard C22.2 No.42M1984 (General Use Receptacles) and C22.2 No. 182.2M1987 (Industrial Locking Type, Special Use Attachment Plugs, Receptacles and Connectors) where applicable.
UL Listing File	UI Listed File #E2258- Guide #RTRT
CSA Certification File	CSA Certified File #LR16215- Guide #365-E-1.
Fed Spec	Federal Specifications WC596 (where applicable).
Complies with:	Complies with NEMA Standards WD-1, WD-6 and UL 498.
Overseas Approvals	NOM, CE.
Catalog Page	Click here for catalog page

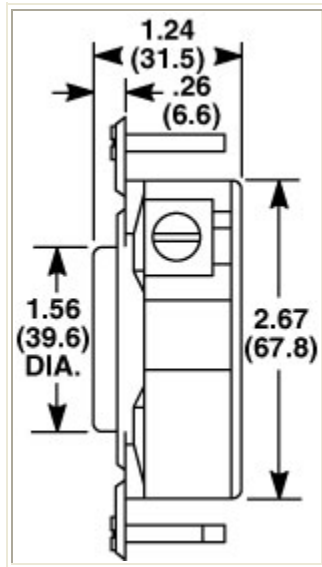
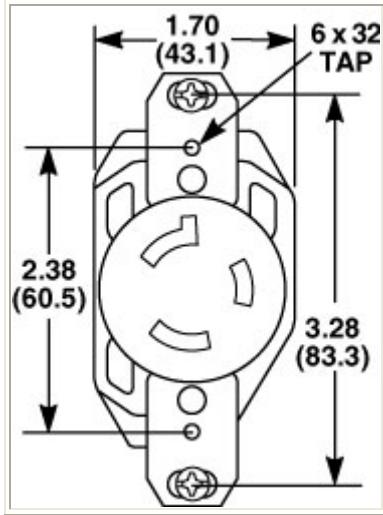

BRYANT®