

Power Supplies

Power Supply Pro 2; 3-phase, 24 VDC, 10 A, 240 W

2787-2346 (/0000-00x0)



© 2022 WAGO GmbH & Co. KG
All rights reserved.

WAGO GmbH & Co. KG

Hansastraße 27
D - 32423 Minden

Phone: +49 571/887 – 0
Fax: +49 571/887 – 844169
E-Mail: ✉ info@wago.com
Internet: 🌐 www.wago.com

Technical Support

Phone: +49 571/887 – 44555
Fax: +49 571/887 – 844555
E-Mail: ✉ support@wago.com

Every conceivable measure has been taken to ensure the accuracy and completeness of this documentation. However, as errors can never be fully excluded, we always appreciate any information or suggestions for improving the documentation.

E-Mail: ✉ documentation@wago.com

We wish to point out that the software and hardware terms as well as the trademarks of companies used and/or mentioned in the present manual are generally protected by trademark or patent.

WAGO is a registered trademark of WAGO Verwaltungsgesellschaft mbH.

Table of Contents

Provisions	6
1.1 Intended Use.....	6
1.2 Typographical Conventions.....	7
1.3 Legal Information	9
Safety	10
2.1 General Safety Rules	10
2.2 Electrical Safety.....	10
2.3 Mechanical Safety	11
2.4 Thermal Safety	11
2.5 Indirect Safety	11
Properties	12
3.1 Introduction.....	12
3.2 View.....	12
3.3 Type label.....	13
3.4 Label.....	14
3.5 Connections	14
3.5.1 Connectors	14
3.5.2 Input	15
3.5.3 Output.....	15
3.5.4 Signal	16
3.6 Indicators.....	16
3.7 Control Elements.....	17
3.7.1 Buttons	17
3.8 Communication interface.....	17
3.9 Technical data	18
3.9.1 Product	18
3.9.2 Input	19
3.9.3 Output.....	19
3.9.4 Efficiency/Power Loss	21
3.9.5 Signal	22
3.9.6 Communication	22
3.9.7 MTBF/Lifespan	22
3.9.8 Environmental Conditions	23
3.9.9 Product Protection	23
3.9.10 Security	24
3.10 Guidelines, approvals and standards	24
3.10.1 Guidelines	24
3.10.2 Approvals	24
3.10.3 Standards	25
3.10.4 Special Requirements	27

Functions	29
4.1 Functions	29
4.2 Overvoltage protection	29
Transport and Storage	30
Installation and Removal	31
Connection	33
7.1 Connection	33
7.2 Connect Conductor to CAGE CLAMP®	33
Operation	35
8.1 Operation via Buttons.....	35
Diagnostics	36
9.1 Diagnostics via Indicators.....	36
Configuration	37
10.1 Requirements	37
10.1.1 System Requirements	37
10.1.2 Install WAGO Interface Configuration Software	37
10.1.3 Configure Product	37
10.2 First Steps	38
10.2.1 Starting the Software	38
10.3 Overview	41
10.3.1 Menu Bar	42
10.3.1.1 “Backstage” Tab	42
10.3.1.2 “Device” Tab	42
10.3.1.2.1 Dialog: Settings.....	42
10.3.1.2.2 Dialog: Simulation	52
10.3.2 Main Menu.....	55
10.3.3 Display Section.....	55
10.3.3.1 Display Section: Measurements	56
10.3.3.2 Display Section: Measurement Recording	58
10.3.3.3 Display Section: Last Error and Warning Messages	60
10.3.3.4 Display Section: Information	61
Notes on Operation	62
11.1 Insulation Testing	62
11.2 Disable/Enable Overvoltage Protection	62
11.2.1 Disable/Enable Input-Side Overvoltage Protection	62
11.2.2 Disable/Enable Output-Side Overvoltage Protection	62
11.3 Inrush Current	63
11.4 Derating.....	63
11.4.1 Derating (Temperature-Dependent)	63
11.4.2 Derating (Location-Dependent)	64
11.5 Parallel Connection	64
11.6 Short-Circuit and Overload Behavior	64

11.6.1	“Constant Current” Mode.....	65
11.6.2	“Constant Current with Latching Shutdown” Mode.....	65
11.6.3	“Hiccup” Mode	66
11.6.4	“Electronic Circuit Breaker” Mode	66
11.6.5	“Latching Shutdown on Thermal Overload” Mode.....	67
11.6.6	“Power Boost” Mode.....	67
11.6.7	“Top Boost” Mode.....	68
11.7	Maintenance.....	69
	Decommissioning	70
12.1	Disposal and Recycling.....	70
	Appendix.....	71
13.1	Application Notes	71
13.1.1	AC Operation.....	71
13.2	Accessories	72
13.3	Protected Rights.....	73

Provisions

This document applies to the following products:

Table 1: Scope of Applicability

Item no.	Item description
2787-2346	WAGO Power Supply Pro 2
2787-2346/0000-0030	WAGO Power Supply Pro 2, with DNV GL Approval
2787-2346/0000-0070	WAGO Power Supply Pro 2, with DNV GL approval and protective coating

Note

Observe the applicable documentation!

This product must only be installed and operated according to the instructions of the complete Instructions for use. Knowledge of the complete Instructions for use is required for proper use.



1. Carefully read the Product Manual.
2. Before commissioning, follow the instructions in section  **Safety [▶ 10]**.

Table 2: Complete instructions for use

Document Type	Contents
 Product Manual	Contains all the product-specific information for a product.
 Instruction leaflet	Is included with each product. Contains initial information on safe handling of the product.

All the documentation and information is available at:  www.wago.com.

1.1 Intended Use

The 2787 Series WAGO Power Supply Pro 2 provides DC voltage to electrical or electronic devices, such as industrial control systems or display, communication and measuring devices.

The product is an open system and is designed for installation in a additional enclosure.

- The product is designed for use in dry indoor rooms.
- Operation of the products in industrial area is permitted.
- The product meets the EMC requirements for residential, office and commercial areas as well as small businesses, if the product used complies with the required emissions of interference (emission limits).
- Operation of the product in other application areas is only permitted when corresponding approvals and labeling are present.

Improper Use

Improper use of the product is not permitted. Improper use occurs especially in the following cases:

- Non-observance of the intended use
- Use without protective measures in an environment in which moisture, salt water, salt spray mist, dust, corrosive fumes, gases, direct sunlight or ionizing radiation can occur

- Use of the product in areas with special risk that require continuous fault-free operation and in which failure of or operation of the product can result in an imminent risk to life, limb or health or cause serious damage to property or the environment (such as the operation of nuclear power plants, weapons systems, aircraft and motor vehicles)

Warranty and Liability

The terms set forth in the General Business and Contract Conditions for Delivery and Service of WAGO GmbH & Co. KG and the terms for software products and products with integrated software stated in the WAGO Software License Contract – both available at www.wago.com – shall apply. In particular, the warranty is void if:

- The product is improperly used.
- The deficiency (hardware and software configurations) is due to special instructions.
- Modifications to the hardware or software have been made by the user or third parties that are not described in this documentation and that has contributed to the fault.

Individual agreements always have priority.

Obligations of Installers/Operators

The installers and operators bear responsibility for the safety of an installation or a system assembled with the products. The installer/operator is responsible for proper installation and safety of the system. All laws, standards, guidelines, local regulations and accepted technology standards and practices applicable at the time of installation, and the instructions in the the products' Instructions for Use, must be complied with. In addition, the Installation regulations specified by Approvals must be observed. In the event of non-compliance, the products may not be operated within the scope of the approval.

1.2 Typographical Conventions





Number Notation

100	Decimals: Normal notation
0x64	Hexadecimals: C-notation
'100'	Binary: In single quotation marks
'0110.0100'	Nibbles separated by a period

Text Formatting

<i>italic</i>	Names of paths or files
bold	Menu items, entry or selection fields, emphasis
Code	Sections of program code
>	Selection of a menu point from a menu
"Value"	Value entries
[F5]	Identification of buttons or keys

Cross References / Links

	Cross references/links to a topic in a document
	Cross references / links to a separate document
	Cross references / links to a website
	Cross references / links to an email address

Action Instructions

- ✓ This symbol identifies a precondition.
- 1. Action step
- 2. Action step
 - ⇒ This symbol identifies an intermediate result.
 - ⇒ This symbol identifies the result of an action.

Lists

- Lists, first level
 - Lists, second level

Figures

Figures in this documentation are for better understanding and may differ from the actual product design.

Notes

DANGER

Type and source of hazard

Possible consequences of hazard that also include death or irreversible injury

- Action step to reduce risk

WARNING

Type and source of hazard

Possible consequences of hazard that also include severe injury

- Action step to reduce risk

CAUTION

Type and source of hazard

Possible consequences of hazard that include at least slight injury

- Action step to reduce risk

NOTICE

Type and source of malfunction (property damage only)

Possible malfunctions that may restrict the product's scope of functions or ergonomics, but do not lead to foreseeable risks to persons

- Action step to reduce risk

Note**Notes and information**

Indicates information, clarifications, recommendations, referrals, etc.

1.3 Legal Information

Intellectual Property

Unless barred by applicable legal provisions, unauthorized copying and distribution of this document, as well as the use and communication of its content are strictly prohibited unless expressly authorized by prior agreement. Third-party products are always mentioned without any reference to patent rights. WAGO GmbH & Co. KG, or for third-party products, their manufacturer, retain all rights regarding patent, utility model or design registration.

Third-party trademarks are referred to in the product documentation. The “®” and “™” symbols are omitted hereinafter. The trademarks are listed in the Appendix ([🔗 Protected Rights \[▶ 73\]](#)).

Subject to Change

The instructions, guidelines, standards, etc., in this manual correspond to state of the art at the time the documentation was created and are not subject to updating service. The installer and operator bear sole responsibility to ensure they are complied with in their currently applicable form. WAGO GmbH & Co. KG retains the right to carry out technical changes and improvements of the products and the data, specifications and illustrations of this manual. All claims for change or improvement of products that have already been delivered – excepting change or improvement performed under guarantee agreement – are excluded.

Licenses

The products may contain open-source software. The requisite license information is saved in the products. This information is also available under [🌐 www.wago.com](http://www.wago.com).

Safety

This section contains safety regulations that must be observed for the safe use of the product.

The following content is aimed at the following target groups:

- Planners and installers
- Operators
- Qualified assembly personnel
- Qualified installation personnel (electrical installation, technician network installation etc.)
- Qualified operating personnel
- Qualified service and maintenance personnel

Obey the following safety rules:

2.1 General Safety Rules

- This documentation is part of the product. Therefore, retain the documentation during the entire service life of the product. Pass on the documentation to any subsequent user of the product. In addition, ensure that any supplement to this documentation is included, if necessary.
- The product must only be installed and put into operation by qualified electrical specialists per EN 50110-1/-2 and IEC 60364.
- Comply with the laws, standards, guidelines, local regulations and accepted technology standards and practices applicable at the time of installation.

2.2 Electrical Safety

- High voltage can cause electric shock or burns! Disconnect all power sources from the product before performing any installation, repair or maintenance.
- Make sure the product does not carry any voltage before starting work.

Power Supply

- Connecting impermissible current or frequency values may destroy the product.
- Provide suitable disconnect and overcurrent protection on the system side. The protection device must be located near the product where it can be operated. The **OFF** position must be clearly marked on the protection device.

Ground / Protection / Overcurrent Protection

- When handling the product, please ensure that environmental factors (personnel, work space and packaging) are properly equalized. Do not touch any conducting parts.
- Establish sufficient grounding. Make sure there is a flawless electrical connection between the DIN-rail and frame / additional enclosure.
- Only operate the product when the ground conductor is connected.
- Protect the product with an appropriate overcurrent protection device.

Conductors

- Only use conductor cross-sections sufficient for the current load.
- Observe permissible temperature range of connecting cables.

- Only clamp one conductor to each connection terminal. If several conductors must be clamped, wire them using an upstream wiring assembly (e.g., WAGO Through Terminal Blocks).
- Use appropriate strain relief.

2.3 Mechanical Safety

- As the installer of the system, you are responsible for ensuring the necessary touch-proof protection. Follow the installation guidelines for the specific application.
- The surrounding air temperature for operation indicated in the technical data applies to the nominal mounting position. Different mounting positions may affect the permissible surrounding air temperature for operation.
- Cooling of the product must not be impaired. Ensure air can flow freely and that the minimum clearances from adjacent products/areas are maintained.
- Before startup, please check the product for any damage that may have occurred during shipping. Do not put the product into operation in the event of mechanical damage.
- Do not open the product housing.
- Replace any defective or damaged devices.
- The product is an open-type device and is designed for installation in an additional enclosure, which supplies the following safety aspects:
 - Restrict access to authorized personnel and may only be opened with tools.
 - Ensure the required pollution degree in the vicinity of the system.
 - Offer adequate protection against direct or indirect contact.
 - Offer adequate protection against UV irradiation.
 - Prevent fire from spreading outside of the enclosure.
 - Guarantee mechanical stability.

2.4 Thermal Safety

- The surface of the housing heats up during operation. Under special conditions (e.g., in the event of a fault or increased surrounding air temperature), touching the product may cause burns. Allow the product to cool down before touching it.
- The temperature inside the additional enclosure must not exceed the surrounding air temperature permitted for the mounted product.

2.5 Indirect Safety

- Only use a dry or cloth or a clothed dampened with water to clean the product. Do not use cleaning agents, e.g., abrasive cleaners, alcohols or acetone.
- Clean tools and materials are imperative for handling the product.
- Before installation and operation, please read the product documentation thoroughly and carefully. In addition, note the information on the product housing and further information, e.g. at www.wago.com/<item number>.
- The product contains no parts that can be serviced by the user. Always have all service, maintenance and repair work performed by specialists authorized by WAGO.
- Observe possible different technical specifications for mounting that does not correspond to the specified mounting position.

Properties

3.1 Introduction

The 2787 Series WAGO Power Supplies Pro 2 are compact switched-mode Power supplies with a wide range of uses. The Power supplies can be fitted on a DIN-rail.

The Power supplies can be configured directly via buttons on the product or via the integrated communication interface. For this purpose, the connection is established either via the WAGO USB Communication Cable or via an attached communication module. It is also possible to record and evaluate various output parameters via the WAGO Interface Configuration software, which is available separately.

The pluggable connection technology uses WAGO pluggable connectors. These allow pre-wiring for quicker installation, as well as quicker and easier product replacement.

LEDs indicate various diagnostic messages (see section Indicators).

3.2 View



Figure 1: View

Table 3: Legend for Figure "View"

Position	Comment	For Details, See Section
a	Ventilation openings	–
b	Signal (X3)	Signal [▶ 16]
c	Output (X2)	Ausgang

Position	Comment	For Details, See Section
d	Screw for overvoltage protection (output)	Overvoltage protection [▶ 29]
e	Optical status indication	Indicators [▶ 16]
f	Buttons	Control Elements [▶ 17]
g	Communication interface	Communication interface [▶ 17]
h	Type label	Type label
i	Marker carrier	Marker carrier [▶ 72]
j	Screw for overvoltage protection (input)	Overvoltage protection [▶ 29]
k	Input (X1)	Input
l	Latch for mounting to/removal from DIN rail	–

3.3 Type label

The type label for the product is attached to the side of the housing. It contains the following information:

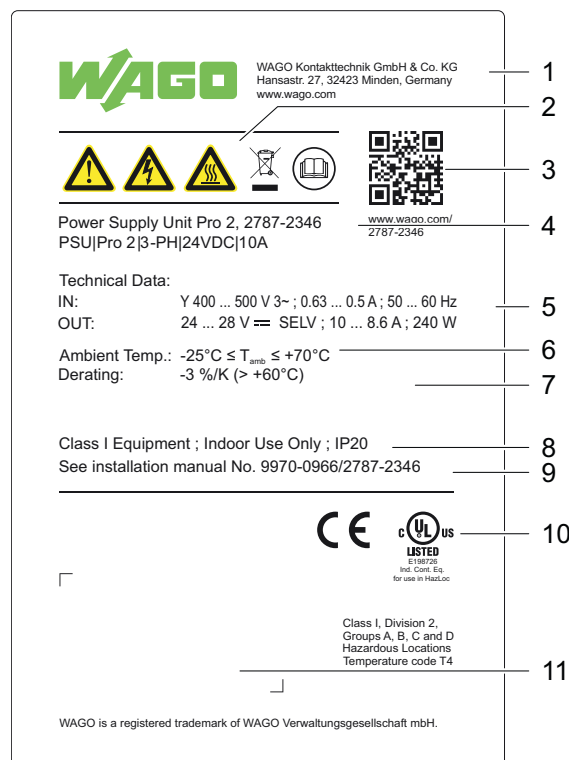

Figure 2: Type label

Table 4: Legend for Figure "Type label"

Position	Comment	For Details, See Section
1	Company logo and address	–
2	Warning notice symbols	Safety [▶ 10]
3	QR link with link to website	–
4	Product name and order number	–
5	Input and output data	Technical data [▶ 18]
6	Surrounding air temperature	Environment requirements
7	Derating information	Derating
8	Additional technical data	Technical data [▶ 18]

Position	Comment	For Details, See Section
9	Information on the instruction leaflet	–
10	Field for guidelines, approvals and standards	Guidelines, approvals and standards [▶ 24]
11	Label with product-specific information	Label

3.4 Label

An additional label with product-specific information is attached to the type label. It contains the following information:

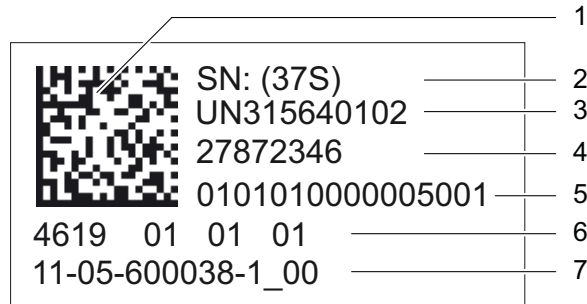

Figure 3: Label

Table 5: Legend for Figure “Label”

Position	Comment	Details
1	2D data matrix code	Contains the information from positions 2 ... 5
2	Key number	Fixed information (37S)
3	ID number per D-U-N-S®	Fixed information (WAGO Minden)
4	WAGO item number or internal SAP number	Product-specific
5	Consecutive number	Product-specific
6	Production date and revision	<ul style="list-style-type: none"> • Production date • Revision index (xx yy zz)
7	Internal manufacturer product number	Product-specific

Table 6: Revision index structure

Software Index	Hardware Index	Boot Loader Index
xx	yy	zz

3.5 Connections

3.5.1 Connectors

Observe the maximum permissible conductor cross sections for the signal and power cables (see section [Technical Data \[▶ 18\]](#)).

Check the associated operating voltage before connecting the equipment (see section [Technical Data \[▶ 18\]](#) or section Type label).

Additional information on the connection technology is provided in section .

3.5.2 Input

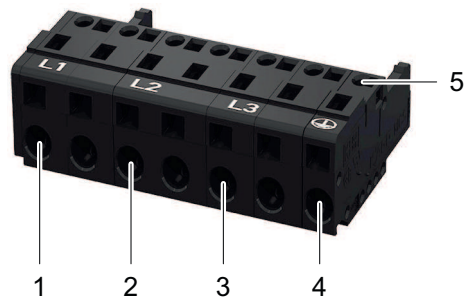

Figure 4: Input X1 Connection

Table 7: Legend for Figure "Input X1 Connection"

Position	Pin	Description
1	1	Contact "L1" for input voltage
2	2	Contact "L2" for input voltage
3	3	Contact "L3" for input voltage
4	4	Contact "PE" for input voltage
5	-	Test slot

Table 8: Details – Input Connection

Series	721 Series (see section Accessories [p 72])
Connection Technology	CAGE CLAMP®

3.5.3 Output

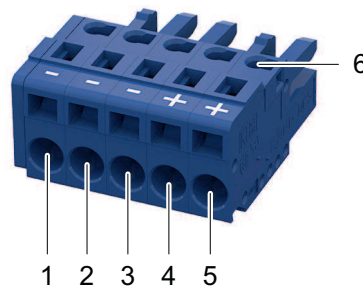

Figure 5: Output X2 Connection

Table 9: Legend for Figure "Output X2 Connection"

Position	Pin	Description
1	1	Contact "-" for output voltage
2	2	Contact "-" for output voltage
3	3	Contact "-" for output voltage
4	4	Contact "+" for output voltage
5	5	Contact "+" for output voltage
6	-	Test slot

Table 10: Details – Output Connection

Series	721 Series (see section Accessories [p 72])
Connection Technology	CAGE CLAMP®

3.5.4 Signal

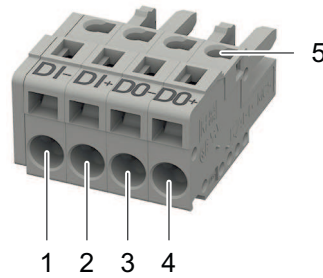

Figure 6: Signal X3 Connection

Table 11: Legend for Figure "Signal X3 Connection"

Position	Pin	Description
1	1	Contact "DI-" for input voltage
2	2	Contact "DI+" for input voltage
3	3	Contact "DO-" for output voltage
4	4	Contact "DO+" for output voltage
5	-	Test slot

Table 12: Details – Signal Connection

Series	721 Series (see section Accessories [▶ 72])
Connection Technology	CAGE CLAMP®

3.6 Indicators

The product has an optical status indicator. This indicator consists of five LEDs.

These LEDs indicate operating states and Diagnostics.

- > 100 % ■
- > 75 % ■
- > 50 % ■
- > 25 % ■
- DC OK ■

Figure 7: Optical Status Indicator

Table 13: Indication of Operating States – General

Indicator	Product is in Standby Mode	Latching Shutdown of Output ¹⁾	Boost Output (Signaled for 5 s)
> 100 % ■	Off	Flashing (0.5 Hz)	Flashing (2 Hz)
> 75 % ■	Off	Off	Steady
> 50 % ■	Off	Off	Steady
> 25 % ■	Off	Off	Steady
DC OK ■	Flashing (0.5 Hz)	Off	Steady

¹⁾ In the event of overload or overtemperature, or if electronic circuit breaker trips

Table 14: Indication of Operating States – Output Power

Indicator	DC OK / Output Power < 25 %	Output Power ≥ 25 % ... < 50 %	Output Power ≥ 50 % ... < 75 %	Output Power ≥ 75 % ... < 100 %	Output Power ≥ 100 %
> 100 % ■	Off	Off	Off	Off	Steady
> 75 % ■	Off	Off	Off	Steady	Steady

Indicator		DC OK / Output Power < 25 %	Output Power ≥ 25 % ... < 50 %	Output Power ≥ 50 % ... < 75 %	Output Power ≥ 75 % ... < 100 %	Output Power ≥ 100 %
> 50 %	■	Off	Off	Steady	Steady	Steady
> 25 %	■	Off	Steady	Steady	Steady	Steady
DC OK	■	Steady	Steady	Steady	Steady	Steady

3.7 Control Elements

This section describes the control elements.

3.7.1 Buttons

Two buttons are located on the front of the product. These buttons are labeled + and -. Among other functions, these two buttons are used to set or adjust the output voltage.



Figure 8: Control elements

Section [🔗 Operation \[▶ 35\]](#) contains a detailed description of how you can use these buttons to make settings.

3.8 Communication interface

The communication interface is covered with a cap. Remove this cap to use the communication interface.

! NOTICE

Avoid destruction of the product by electrostatic discharge!

The contacts of the communication interface are very sensitive to electrostatic discharge (ESD). If the contacts remain open continuously, the product can be destroyed!

- Remove the cap only when using the communication interface!

i Note

Save cap!

Save the cap so you can re-close the communication interface after use. This prevents contamination or foreign matter from getting into the open communication interface.

You can communicate with the product through the communication interface. The following options are available for this:

- Via the WAGO USB Communication Cable (see section Accessories)
- Via an attachable communication module (see section Accessories)

The WAGO USB Communication Cable is intended exclusively for parameterization and is not designed for continuous communication. Use a corresponding communication module for continuous communication!

If you use a communication module, the corresponding communication module is described in the  **Product Manual**.

To connect to a PC with the WAGO USB Communication Cable, perform the following steps:

1. Remove the cap.
2. Connect the USB connector of the WAGO USB Communication Cable to your PC.
3. Carefully insert the plug for the communication interface straight into the communication interface in such a way that the keying tab fits into the lower recess.
 - ⇒ The plug is seated correctly once it has been inserted into the interface up to the stop. However, since the contours of the housing and plug differ, the plug does not sit completely flush with the surface of the housing.

You can now connect to your product with the WAGO Interface Configuration software and configure it (see section  **Configuration** [[▶ 371](#)]).

3.9 Technical data

3.9.1 Product

Table 15: Technical Data – Product

Property	Value
Width	50 mm
Height	130 mm
Depth	130 mm (from the top edge of the DIN-rail)
Weight	1000 g
Degree of protection	IP20

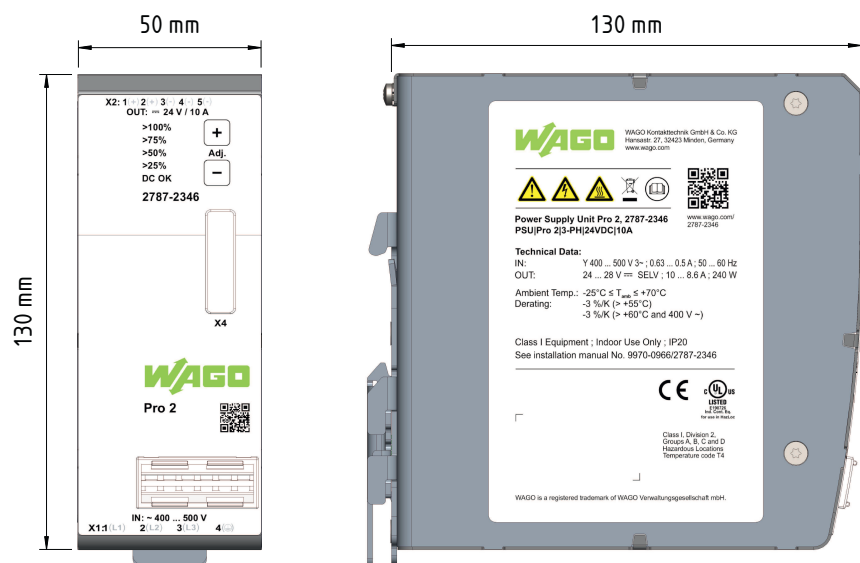

Figure 9: Dimensions

3.9.2 Input

Table 16: Technical Data – AC Input

Property	Value	
Number of phases	3 (2 at nominal input voltage \geq 400 VAC)	
Nominal input voltage	3 \times 400 ... 500 VAC (without neutral conductor)	
Input Voltage Range	3 \times 340 ... 550 VAC	
Input frequency	50 ... 60 Hz	
Grounding systems	TN, TT and IT networks	
Input current (typ.) ¹⁾	400 VAC	0.63 A
	480 VAC	0.5 A
Power factor (typ.) ¹⁾	400 VAC	0.92
	480 VAC	0.88

¹⁾ At nominal load and nominal input voltage 400 VAC (3 phases)

Table 17: Technical Data – Inrush Current

Property	Value	
Inrush current (typ.) ¹⁾	400 VAC	1.0 A

¹⁾ At room temperature of 25 °C and after 1 ms

Table 18: Technical Data – Mains Failure Buffering Time

Property	Value	
Mains failure buffering time, typ. ¹⁾	400 VAC	21 ms
	480 VAC	42 ms
Holding time, typ. ¹⁾	400 VAC	21 ms
	480 VAC	42 ms

¹⁾ At nominal load

Table 19: Technical Data – Input Connection

Property	Value	
Cross-section	Solid	0.08 ... 2.5 mm ² / 28 ... 12 AWG
	Fine-stranded	0.08 ... 2.5 mm ² / 28 ... 12 AWG
	Insulated ferrule with plastic collar	0.25 ... 1.5 mm ² / 20 ... 16 AWG
	Ferrule without plastic collar	0.25 ... 2.5 mm ² / 20 ... 14 AWG
Strip length	8 ... 9 mm / 0.31 ... 0.35 inch	
Specifications of the conductors used	\geq +75°C / +167°F (ambient air temperature: \leq +60°C / 140°F) \geq +90°C / 194°F (ambient air temperature: $>$ +60°C / 140°F)	
Required tools (conductor termination)	Operating tool, with a partially insulated shaft, type 2 (see section Accessories [P 72])	

3.9.3 Output

Table 20: Technical Data – Output

Property	Value
Nominal output voltage	24 VDC SELV ¹⁾
Output voltage range	24 ... 28 VDC SELV
Nominal output current	10 A (see section Derating)
Output current range	10 ... 8.6 A
Output power ²⁾	240 W

Property	Value	
Power Boost	15 A (5 s)	
Top Boost	60 A (15 ms)	
Derating of output power	See section Derating	
Line regulation ²⁾	< 0.02 %	
Load regulation ³⁾	< 2.5 %	
Residual ripple/noise ⁴⁾	< 50 mV	
Overload behavior ^{5) 6)}	“Constant Current” Mode ¹⁾ “Constant Current with Latching Shutdown” Mode “Hiccup” Mode “Electronic Circuit Breaker” Mode “Latching Shutdown on Thermal Overload” Mode “Power Boost” Mode “Top Boost” Mode	
Switch-on delay (typ.) ^{6) 7)}	400 VAC	1.5 s

- ¹⁾ Factory setting
- ²⁾ Nominal load, in range 340 ... 550 VAC
- ³⁾ 10 % / 90 % load step
- ⁴⁾ 20 MHz bandwidth
- ⁵⁾ See section [Short-Circuit and Overload Behavior \[▶ 64\]](#)
- ⁶⁾ Can be set via the WAGO Interface Configuration software
- ⁷⁾ See figure “Turn-on Time”

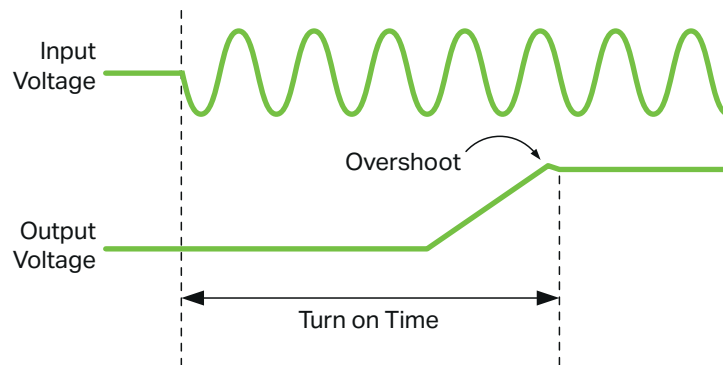

Figure 10: Turn-on Time

! NOTICE

Select conductor cross-sections according to current load!

In the event of a fault, the output current of a power supply can be up to $1.5 \times I_{OUT}$. Only use conductor cross-sections sufficient for the current load!

Table 21: Technical Data – Output Connection

Property	Value	
Cross-section	Solid	0.08 ... 2.5 mm ² / 28 ... 12 AWG
	Fine-stranded	0.08 ... 2.5 mm ² / 28 ... 12 AWG
	Insulated ferrule with plastic collar	0.25 ... 1.5 mm ² / 20 ... 16 AWG
	Ferrule without plastic collar	0.25 ... 2.5 mm ² / 20 ... 14 AWG
Strip length	8 ... 9 mm / 0.31 ... 0.35 inch	

Property	Value
Specifications of the conductors used	$\geq +75^{\circ}\text{C} / +167^{\circ}\text{F}$ (ambient air temperature: $\leq +60^{\circ}\text{C} / 140^{\circ}\text{F}$) $\geq +90^{\circ}\text{C} / 194^{\circ}\text{F}$ (ambient air temperature: $> +60^{\circ}\text{C} / 140^{\circ}\text{F}$)
Required tools (conductor termination)	Operating tool, with a partially insulated shaft, type 2 (see section Accessories [p 72])

3.9.4 Efficiency/Power Loss

Table 22: Technical Data – Efficiency/Power Loss

Property	Value
Efficiency, typ. ¹⁾	400 VAC 92.8 %
	480 VAC 92.0 %
Power loss, typ. ¹⁾	400 VAC 10.1 W
	480 VAC 10.9 W

¹⁾ At nominal load

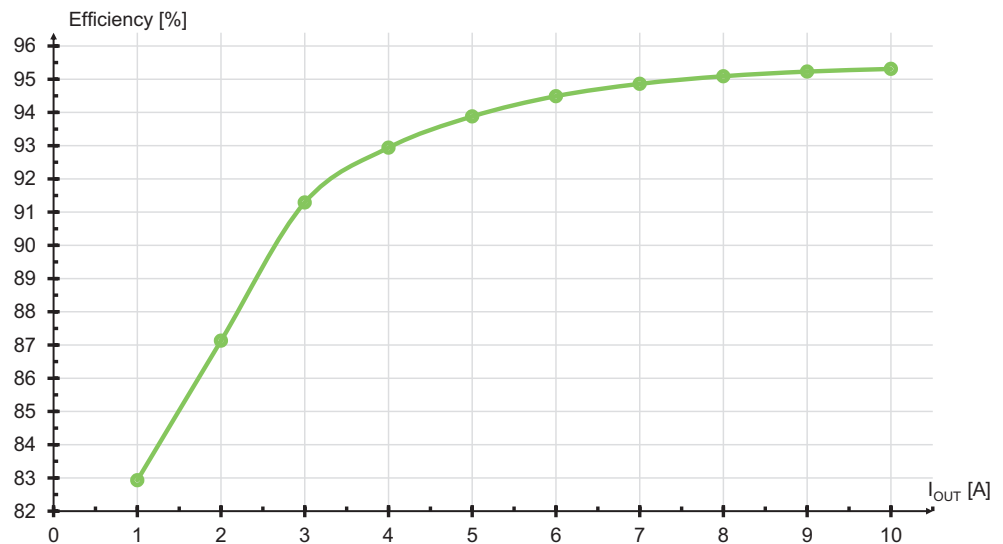

Figure 11: Efficiency (typ.) at 400 VAC

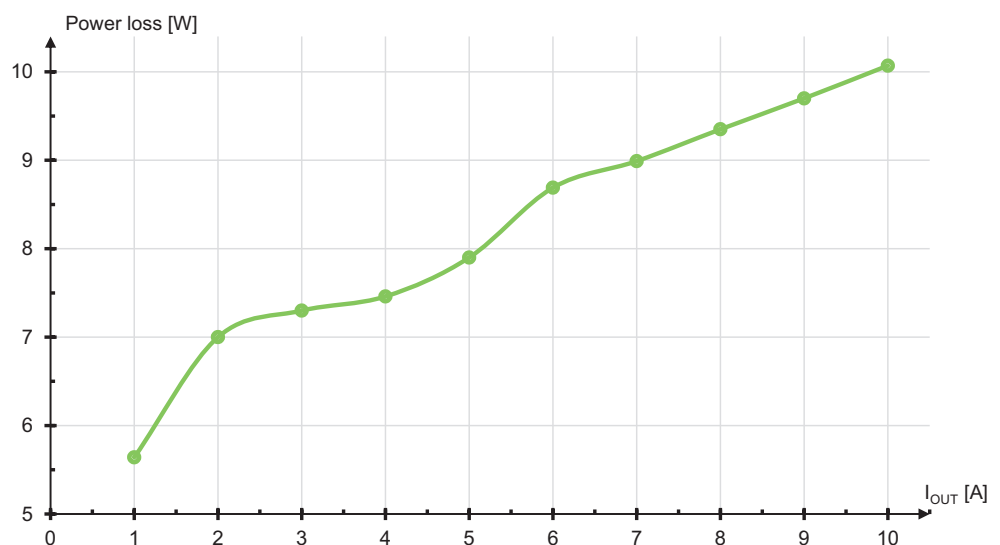

Figure 12: Power loss (typ.) at 400 VAC

3.9.5 Signal

Table 23: Technical Data – Signal (Input DI)

Property	Value
Signal type	24 VDC
Voltage range for signal (0)	-3 ... +5 VDC
Voltage range for signal (1)	15 ... 30 VDC
Input current for signal (1) ¹⁾	4.5 mA
Isolation voltage	See section Safety

¹⁾ at 24 VDC

Table 24: Technical Data – Signal (Output DO)

Property	Value
Switch-on threshold, typ.	UOUT > USET × 0.93
Switch-off threshold, typ.	UOUT < USET × 0.87
Contact load, max.	50 mA
Voltage drop, typ.	< 100 mV (at 50 mA)
Contact voltage, max.	31.2 VDC
Polarity	Freely selectable
Series operation	Yes; a series connection of up to 10 signal contacts is permitted.
Implementation type	PhotoMOS
Isolation voltage	See section Safety

Table 25: Technical Data – Signal Connection

Property	Value	
Cross-section	Solid	0.08 ... 2.5 mm ² / 28 ... 12 AWG
	Fine-stranded	0.08 ... 2.5 mm ² / 28 ... 12 AWG
	Insulated ferrule with plastic collar	0.25 ... 1.5 mm ² / 20 ... 16 AWG
	Ferrule without plastic collar	0.25 ... 2.5 mm ² / 20 ... 14 AWG
Strip length	8 ... 9 mm / 0.31 ... 0.35 inch	
Specifications of the conductors used	≥ +75°C / +167°F (ambient air temperature: ≤ +60°C / 140°F) ≥ +90°C / 194°F (ambient air temperature: > +60°C / 140°F)	
Required tools (conductor termination)	Operating tool, with a partially insulated shaft, type 2 (see section Accessories [▶ 72])	

3.9.6 Communication

Table 26: Technical Data – Communication

Property	Value
Data timeliness of the communication interface	200 ms

3.9.7 MTBF/Lifespan

Table 27: Technical Data – MTBF/Lifespan

Property	At	Load	T _{amb}	Value
MTBF, typ. (SN 29500) (IEC 61709)	24 VDC SELV	100 %	25 °C	1000000 h
	24 VDC SELV	100 %	40 °C	600000 h

3.9.8 Environmental Conditions

Table 28: Technical Data – Environmental Conditions

Property	Value
Surrounding air temperature, operation	-25 ... +70 °C
Surrounding air temperature, restricted operation ¹⁾	-40 ... -25 °C
Surrounding air temperature, storage	-40 ... +85 °C
Derating (temperature-dependent) ²⁾	-3 %/K (> +60 °C)
Derating (location-dependent) ²⁾	-13.0 %/1000 m (> +60 °C; 2000 m or higher)
Relative humidity	5 ... 96 % (no condensation permissible)
Elevation above sea level, max.	5000 m
Overvoltage category	III (≤ 2000 m) II (> 2000 m)
Vibration according to IEC 60068-2-6	5 ... 150 Hz / 1g
Shock according to IEC 60068-2-27	15 g / 11 ms
Pollution degree according to IEC/EN 60664-1	2
Resistance to harmful gas ³⁾	Resistant to flowing mixed gas per ISA S71.04, G3 Group A

¹⁾ Without mechanical actuation of buttons, female connectors etc., for example

²⁾ See section [Derating \[▶ 63\]](#)

³⁾ Only applies to 2787-2346/0000-0070

Note

Observe the following for long-term storage:

For long-term storage, power must be applied to equipment with built-in capacitors for five minutes at least every two years.

3.9.9 Product Protection

Table 29: Technical Data – Product Protection

Property	Value
Internal input fuse ¹⁾	Unavailable
Transient suppression at input	Yes, varistor
Overload protection at output	Electronic
Overvoltage protection at output, max. ²⁾	32 VDC
Feedback voltage, max. ³⁾	Yes, max. 32 V
Degree of protection	IP20
Ingress protection against foreign objects	> 4 mm
Overtemperature protection ⁴⁾	Yes
Circuit breaker of the nominal current circuit ⁵⁾	16 A (for USA/Canada: 15 A)

¹⁾ Used only as an AC fuse. An external DC fuse must be used with DC supply.

²⁾ Internal limitation via a second control loop, deactivation of power supply, automatic restart

³⁾ The voltage must not be exceeded due to power feedback.

⁴⁾ Configurable; see section [“Latching Shutdown on Thermal Overload” Mode \[▶ 67\]](#)

⁵⁾ The circuit breaker can be used for activation during installation. In this case, the circuit breaker must meet all the requirements on this shutdown device. If an additional switch is used, it must have the same electrical load capacity as the circuit breaker.

3.9.10 Security

Table 30: Technical Data – Safety

Property	Value
Input and output insulation, according to EN 61010-1; EN 61010-2-201	SELV/PELV
Protection class, with protective wire connection	I
Isolation voltage (input – output), ref. A ¹⁾	3.51 kVAC
Isolation voltage (input – ground), ref. B ¹⁾	2.2 kVAC
Isolation voltage (output – ground), ref. C ¹⁾	500 VAC
Isolation voltage (output – digital input / output – digital output), ref. D ¹⁾	500 VAC

¹⁾ Type test (rise 5 s – stay 2 s – fall 5 s); see figure “Dielectric Strength”

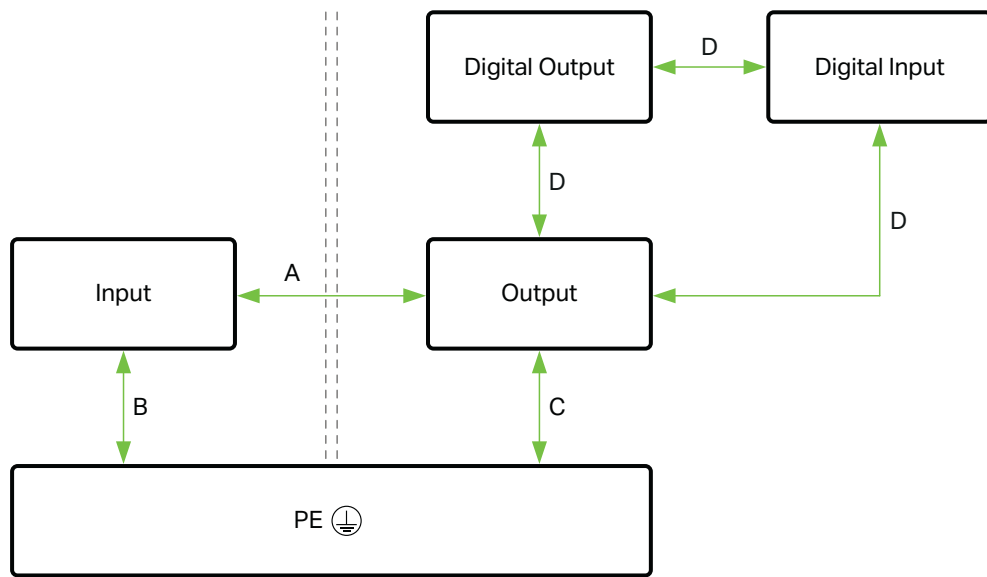

Figure 13: Dielectric Strength

3.10 Guidelines, approvals and standards

3.10.1 Guidelines

An EU “Declaration of Conformity” and CE marking exist for the product:

Table 31: Guidelines



Logo	Explanation	Verification
	CE marking	WAGO website

3.10.2 Approvals

The following approvals have been granted for the product:

Table 32: Approvals

Logo	Certification Body	Standard
	Underwriters Laboratories Inc. (Ordinary Locations)	UL 61010-1

Logo	Certification Body	Standard
	Underwriters Laboratories Inc. (Ordinary Locations)	UL 61010-2-201
	Underwriters Laboratories Inc. (Hazardous Locations)	UL 121201 ^{1) 2)}
	DNV GL	CG-0339 ^{1) 2)}

¹⁾ Only applies to 2787-2346/0000-0030

²⁾ Only applies to 2787-2346/0000-0070

Note

More information on approvals

You can find detailed information on the approvals online at:

 www.wago.com/<item number>

3.10.3 Standards

The product meets the following standards:

Table 33: Standards: Mechanical and Climatic Environmental Conditions

Standard	Test Value
Mechanical Environmental Conditions	
EN 60068-2-6	f = 5 ...150 Hz: 1g, 3.5 m
IEC 60068-2-27 shock	15g, 11 ms, 3 shocks per axis and direction, half-sine
EN 61131-2, sec. 4.3	Freefall ≤ 300 mm (packaged in the product packaging)
Climatic Environmental Conditions	
EN 60870-2-2	3K3 (except for low air pressure)

Table 34: Standards: EMC – Immunity to Interference

Standard	Title
EN IEC 61204-3	Low-Voltage Switch Mode Power Supplies – Part 3: Electromagnetic Compatibility (EMC)
EN IEC 61000-6-2	Part 6-2: Generic standards – Immunity for industrial environments
EN 61000-4-2	Part 4-2: Testing and measurement techniques – Electrostatic discharge immunity test
EN 61000-4-3	Part 4-3: Testing and measurement techniques – Radiated, radio-frequency, electromagnetic field immunity test
EN 61000-4-4	Part 4-4: Testing and measurement techniques – Electrical fast transient/ burst immunity test
EN 61000-4-5	Part 4-5: Testing and measurement techniques – Surge immunity test
EN 61000-4-6	Part 4-6: Testing and measurement techniques – Immunity to conducted disturbances, induced by radio-frequency fields
EN 61000-4-8	Part 4-8: Testing and measurement techniques – Power frequency magnetic field immunity test
EN 61000-4-11	Part 4-11: Testing and measurement techniques – Voltage dips, short interruptions and voltage variations immunity tests

Table 35: Standards: EMC – Emission of Interference

Standard	Title
EN IEC 61204-3	Low-Voltage Switch Mode Power Supplies – Part 3: Electromagnetic Compatibility (EMC)
EN 61000-6-3	Part 6-3: Generic standards – Emission standard for residential, commercial and light-industrial environments

Table 36: Standards: LVD – Low Voltage Directive

Standard	Title
EN IEC 61010-2-201	Safety requirements for electrical equipment for measurement, control, and laboratory use - Part 2-201: Particular requirements for control equipment
EN 61010-1	Safety requirements for electrical equipment for measurement, control, and laboratory use - Part 1: General requirements

The following tests have been performed in accordance with the EMC standards listed:

Table 37: Standards: EMC – Immunity to Interference (Tests Performed)

Standard	Title	Test	Value	Category
EN 61000-4-2	Part 4-2: Testing and measurement techniques – Electrostatic discharge immunity test	Contact discharge	6 kV	B
		Air discharge	2 kV/4 kV/8 kV	B
EN 61000-4-3	Part 4-3: Testing and measurement techniques – Radiated, radio-frequency, electromagnetic field immunity test	80 MHz ... 1.0 GHz (1 kHz AM 80 %)	10 V/m	A
		1.0 ... 2.0 GHz (1 kHz AM 80 %)	10 V/m	A
		2.0 ... 6.0 GHz (1 kHz AM 80 %)	10 V/m	A
EN 61000-4-4	Part 4-4: Testing and measurement techniques – Electrical fast transient/burst immunity test	AC input	2 kV, 5 kHz/100 kHz, 5 min.	A
		DC output	2 kV, 5 kHz/100 kHz, 5 min.	A
		DC OK/digital input/digital output	1 kV, 5 kHz/100 kHz, 5 min.	A
		Communication	1 kV, 5 kHz/100 kHz, 5 min.	A
EN 61000-4-5	Part 4-5: Testing and measurement techniques – Surge immunity test	L → L	1 kV	B
		L → PE	2 kV	B
		L+ → L-	0.5 kV	B
		L+ → PE L- → PE	1 kV	B
		DC OK/digital input/digital output → PE	1 kV	B
EN 61000-4-6	Part 4-6: Testing and measurement techniques – Immunity to conducted disturbances, induced by radio-frequency fields	AC input	0.15 ... 80 MHz: 10 V	A
		DC output	0.15 ... 80 MHz: 10 V	A
		DC OK/digital input/digital output	0.15 ... 80 MHz: 10 V	A
		Communication	0.15 ... 80 MHz: 10 V	A

Standard	Title	Test	Value	Category
EN 61000-4-8	Part 4-8: Testing and measurement techniques – Power frequency magnetic field immunity test	50/60 Hz	30 A/m	A
EN 61000-4-11	Part 4-11: Testing and measurement techniques – Voltage dips, short interruptions and voltage variations immunity tests	0 % of 100 VAC (50 ... 60 Hz)	0.5 cycles	A
		0 % of 100 VAC (50 ... 60 Hz)	1 cycle	A
		40 % of 100 VAC (50 ... 60 Hz)	10/12 cycles	A
		70 % of 100 VAC (50 ... 60 Hz)	25/30 cycles	A
		80 % of 100 VAC (50 ... 60 Hz)	250/300 cycles	A
		0 % of 100 VAC (50 ... 60 Hz)	250/300 cycles	B

Table 38: Legend for “Standards: EMC – Immunity to Interference (Tests Performed)”

Category	Description
A	Normal operation within specification limits
B	Temporary degradation of function that is self-recoverable after interference
C	Temporary loss of function that requires operator intervention or system reset

Table 39: Standards: EMC – Emission of Interference (Tests Performed)

Standard	Title	Test	Value
EN 55016-2-1	Part 2-1: Methods of measurement of disturbances and immunity – Conducted disturbance measurements (CISPR 16-2-1)	Conducted disturbance AC input	Class B (residential area) at nominal load
		Conducted disturbance DC output	Class B (residential area) at nominal load
EN 55016-2-3	Part 2-3: Methods of measurement of disturbances and immunity – Radiated disturbance measurements (CISPR 16-2-3)	Housing interference radiation	Class B (residential area) at nominal load
EN 61000-3-2	Part 3-2: Limits – Limits for harmonic current emissions (equipment input current ≤ 16 A per phase)	Upper harmonic input currents	Class A fulfilled at nominal load

3.10.4 Special Requirements

Observe the following:

- Perform installation according to the local conditions, applicable regulations (e.g., VDE 0100), national accident prevention specifications (e.g., UVV-VBG4 or DGUV Regulation 2) and accepted technical regulations.
- This product is intended for installation in electrical systems or machines and fulfills the requirements of the Low Voltage Directive.

When installing in machines, the following also applies:

- When installing in machines, normal operation must not commence until it is determined that the machine complies with the requirements of the Machinery Directive, EN 60204.
- Commencement of normal operation is allowed only on the condition of compliance with the EMC Directive.

- The manufacturer of the system or machine is responsible for ensuring compliance with the limit values required by EMC legislation.

Functions

4.1 Functions

The product has the following integrated functions:

Table 40: Functions

Function	Description
Top Boost	Supplies up to 600 % more output current for 15 ms.
Power Boost	Supplies up to 150 % of the output current for 5 s.
Recording and displaying measured values	For details, see section Display Section: Measured Values.
Recording and displaying time series of measured values	For details, see section Display Section: Measurement Recording.
Configurable overload behavior	For details, see section Dialog:Settings.
Configurable DI/DO interface	For details, see section Dialog:Settings.
Configurable load management	For details, see section Dialog:Settings.
Communication interface	Allows connection via a WAGO USB Communication Cable (see section Communication Interface) or via a communication module that is available as an option. The communication modules allow configuration and monitoring of the product via fieldbus systems.

4.2 Overvoltage protection

The product is protected against overvoltage. For insulation testing on your electrical equipment, this protection can be removed. The following test voltages apply:

Table 41: Test voltages on the input side

Overvoltage Protection	Test voltage
Input	> 600 VDC
	> 420 VAC

How to enable and disable overvoltage protection is described in Section [🔗 Enable/Disable Input-Side Overvoltage Protection \[▶ 62\]](#).

Table 42: Test voltages on the output side

Overvoltage Protection	Test voltage
Output	> 225 VDC
	> 175 VAC

How to enable and disable overvoltage protection is described in Section [🔗 Enable/Disable Output-Side Overvoltage Protection \[▶ 62\]](#).

You can find explicit information on maximum insulation voltages in the Section Safety.

Transport and Storage

The original packaging offers optimal protection during transport and storage.

- Store the product in suitable packaging, preferably the original packaging.
- Only transport the product in suitable containers/packaging.
- Make sure the product contacts are not contaminated or damaged during packing or unpacking.
- Observe the specified ambient climatic conditions for transport and storage ( [Technical data \[► 18\]](#)).

Installation and Removal

! NOTICE

Avoid electrostatic discharge!

The products are equipped with electronic components that you may destroy by electrostatic discharge when you touch. Please observe the safety precautions against electrostatic discharge in accordance with EN 61340-5-1/-3. Pay attention while handling the products to good grounding of the environment (persons, job and packing).

! NOTICE

Do not cover the ventilation openings!

To ensure adequate air circulation, the ventilation openings must be kept clear. Maintain a distance of at least 50 mm from the ventilation openings to adjacent surfaces.

The letters shown in parentheses refer to positions in the “View” figure in section View.

Mounting Positions

- Nominal mounting position (see also figure under View): Front side facing forwards, marking legible, and bottom ventilation openings facing upwards and downwards.
- Never operate the product directly next to other components!

Table 43: Minimum Clearances

Installation Clearances		Clearance
Passive adjacent device (adjacent device does not generate heat)	Above/below	50 mm
	On side	6 mm
Active adjacent device (adjacent device generates additional heat; equivalent product under full load)	Above/below	50 mm
	On side	12 mm

DIN-35 Rail

The DIN-35 rail is located in the center of the vertical axis (height) of the product (see section [Technical Data \[▶ 18\]](#)).

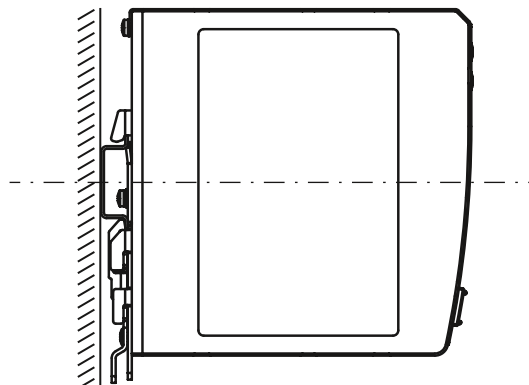

Figure 14: Position of the DIN-35 rail

The distances from the central axis of the DIN-35 rail to the top and bottom are 65 mm.

Mounting per DNV GL

The following instructions apply for installation per DNV GL:

- Mount the product on a DIN-rail (210-197 or 210-118).
- Place an end bracket on the left and right of the product (249-117).

Mounting on the DIN-35 Rail

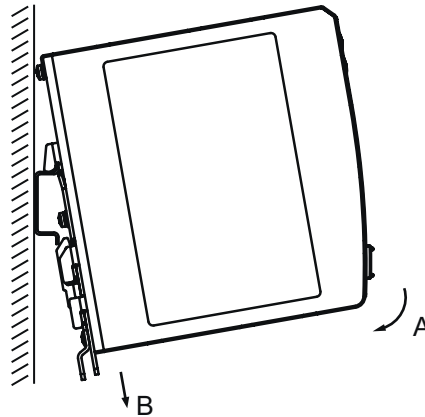

Figure 15: Mounting

Install the product as per EN 60715 by snapping it onto the DIN-35 rail (see figure “Mounting”):

1. Place the product, with its DIN-35 rail guide, on the top edge of the DIN-35 rail.
2. Press the product onto the DIN-35 rail [A] while simultaneously pulling on the latch (I) on [B] until it locks into place.
3. To ensure secure fastening on the DIN-35 rail, fit end stops on either side of the product (e.g., order no. **249-197**).

Removing from the DIN-35 Rail

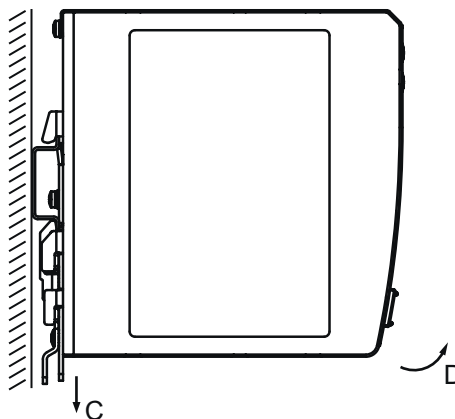

Figure 16: Removing

1. To remove (see figure “Removing”), pull the latch (I) down [C], using a screwdriver or an operating tool.
2. Pivot the product to remove it from the DIN-35 rail [D].

Connection

7.1 Connection

DANGER

Live parts that can be touched

High voltage can cause electric shock or burns.

1. Disconnect the product from conductors that may be live, or switch off the corresponding power supplies. Protect power supplies that have been switched off against being switched back on.
 2. Verify that all parts that can be touched are actually voltage-free.
- ⇒ Work can now be performed on the product.

Observe the maximum permissible conductor cross sections for the signal and power cables (see section [🔗 Technical Data \[▶ 18\]](#)).

Check the appropriate operating voltage before connecting the equipment (see section Type label).

Connect per UL Hazardous Location

WARNING

Explosion hazard!

Do not disconnect equipment unless power has been switched off or the area is known to be non-hazardous.

WARNING

Explosion hazard!

Substitution of components may impair suitability for Class I, Division 2.

This product is suitable for use in Class I, Division 2, Groups A, B, C and D or non-hazardous locations only.

7.2 Connect Conductor to CAGE CLAMP®

CAGE CLAMP® Connectors are designed for solid, stranded and fine-stranded conductors.

i Note**Only connect one conductor to each CAGE CLAMP® connection!**

Only one conductor may be connected to each CAGE CLAMP® connection. Do not connect more than one conductor on one single connection.

If more than one conductor must be routed to one connection, these must be connected in an up-circuit wiring assembly, for example, using WAGO Through Terminal Blocks.

To connect the conductors, use an operating tool (see section Accessories) or an appropriate screwdriver.

Perform the following steps to make the connection:

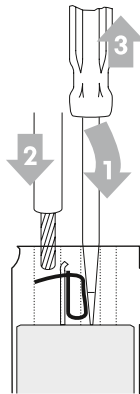

Figure 17: Connect Conductor to CAGE CLAMP®

1. To open the CAGE CLAMP®, insert the operating tool into the opening above the connection.
⇒ Once you hear a click, the CAGE CLAMP® is open.
2. Insert the conductor into the corresponding connection opening.
3. Remove the operating tool to close the CAGE CLAMP®.
⇒ The conductor is now securely clamped.

Operation

8.1 Operation via Buttons

Using the + und – buttons on the front of the product, you can make the following settings:

Table 44: Operation via Buttons

Button [+]	Button [-]	Function
Switch product on or off		
Hold down simultaneously for 3 seconds		The product is switched on or off.
Set output voltage		
Press once	-	The output voltage increases in steps.
Press and hold	-	The output voltage increases continuously.
-	Press once	The output voltage is reduced in steps.
-	Press and hold	The output voltage is reduced continuously.
Reset product to factory settings		
Hold down simultaneously for 10 seconds		The product is reset to the factory settings.

During ongoing operation, you can set the output voltage and reset the product to the factory settings. These settings can be saved and then remain available when the product is switched off and back on.

Diagnostics

9.1 Diagnostics via Indicators

The product has an optical status indicator. This indicator consists of five LEDs.

These LEDs indicate operating states and diagnostics.

Table 45: Display of Diagnostics – Warnings

Indicator		Output Voltage Too Low	Output Voltage Too High	Overload Threshold or Tripping Current of Electronic Circuit Breaker Exceeded
> 100 %	■	Flashing (2 Hz)	Flashing (2 Hz)	Flashing (2 Hz)
> 75 %	■	Off	Flashing (2 Hz)	Signaling of regular utilization
> 50 %	■	Off	Off	
> 25 %	■	Off	Off	
DC OK	■	Flashing (2 Hz)	Off	

Table 46: Diagnostic Indicators – Errors

Indicator		Short Circuit at Output	Overtemperature Shutdown ¹⁾	Internal Product Fault	Communication interface
> 100 %	■	Flashing (8 Hz)	Flashing (8 Hz)	Flashing (8 Hz)	Flashing (8 Hz)
> 75 %	■	Off	Steady	Flashing (8 Hz)	Off
> 50 %	■	Off	Off	Flashing (8 Hz)	Off
> 25 %	■	Off	Off	Flashing (8 Hz)	Off
DC OK	■	Off	Off	Flashing (8 Hz)	Steady

¹⁾ Automatic restart (factory setting)

Configuration

10.1 Requirements

10.1.1 System Requirements

The following system requirements must be met for the WAGO Interface Configuration software to be installed:

Minimum System Requirements

Table 47: Minimum System Requirements

Components	Requirements
Operating system	<ul style="list-style-type: none"> Windows 7 (32- and 64-bit) Windows 8 (32- and 64-bit) Windows 8.1 (32- and 64-bit) Windows 10 (32- and 64-bit)
Memory	2 GB
Free hard disk space	150 MB
Processor	1 GHz or higher, 32-bit (x86) or 64-bit (x64)
Screen resolution	800 × 600 pixels

Recommended System Requirements

Table 48: Recommended System Requirements

Components	Requirements
Operating system	Windows 10 (64-bit)
Memory	8 GB
Free hard disk space	250 MB
Processor	1 GHz or higher, 64-bit (x64)
Screen resolution	1920 × 1080 pixels

10.1.2 Install WAGO Interface Configuration Software

1. Open the  [WAGO website](#).
2. Download the **WAGO Interface Configuration software G2**.
3. Start the installation process by double-clicking the installation file. This requires administrator rights.
4. Choose whether to create a desktop icon and whether you want to launch the software immediately.
5. Click **[Finish]** to complete installation.

10.1.3 Configure Product

Configuring the product requires the WAGO Interface Configuration software to be installed (see also section  [Install WAGO Interface Configuration Software \[▶ 37\]](#)).

You can use the software to configure the product either online or offline (see also section Dialog: Settings).

The following requirements must be met before you can work online with the WAGO Interface Configuration software:

- The product must be connected to the computer on which the WAGO Interface Configuration software is installed.
- The product must be supplied with power.

The following description relates to the example of connecting the product to a computer via a WAGO USB Communication Cable.

10.2 First Steps

The following steps are based on the WAGO Interface Configuration software G2, Version 01.00.06.18 and Firmware Version 01.05.xx. If you have other versions, individual settings and functions may differ slightly from those illustrated or may not be available.

10.2.1 Starting the Software

To start the software, click the corresponding symbol on your desktop or open the software from the Windows Start menu.

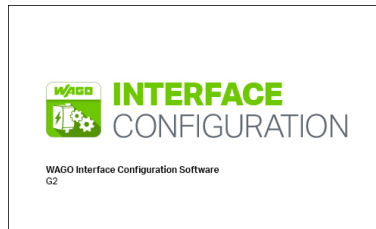

Figure 18: Software Start

After the software starts, a window opens showing the menu bar.

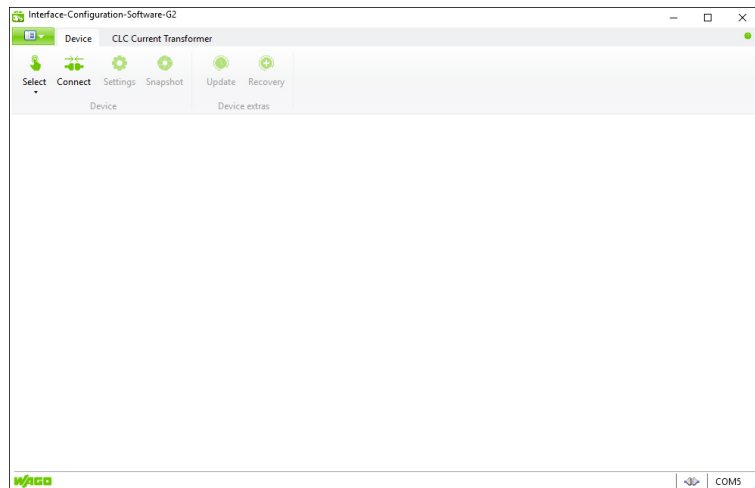

Figure 19: Start View

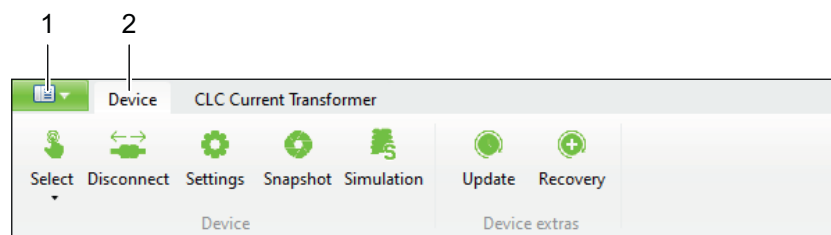

Figure 20: Start View – Tabs

Table 49: Legend for Figure "Start View – Tabs"

No.	Tab
1	Backstage
2	Device

To set up the product in the software for the first time, carry out the following steps on the two tabs:

"Backstage" Tab

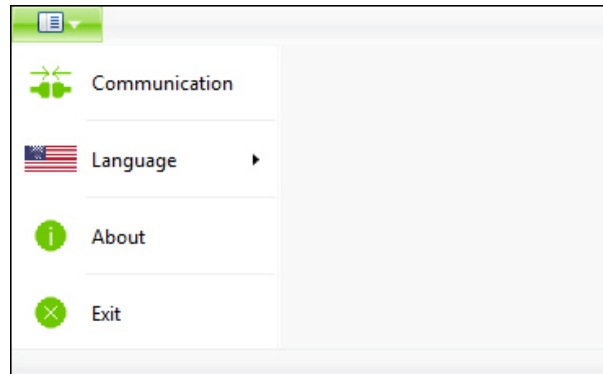

Figure 21: "Backstage" Tab

Table 50: "Backstage" Tab

Menu Item	Description
Communication	Selects the connection between the product and software.
Language	Selects the display language for the software.
Help	Opens the help for the software.
About	Displays information about the software (e.g., version).
Exit	Closes the software and the dialog.

On this tab, you can make the following settings:

1. Select the **Communication** menu item.
2. In the "Communication Settings" dialog, under **COM Port**, select the corresponding entry for your connection between the computer and the product (example: **WAGO USB service cable**).
3. Click **[Save]**.

"Device" Tab

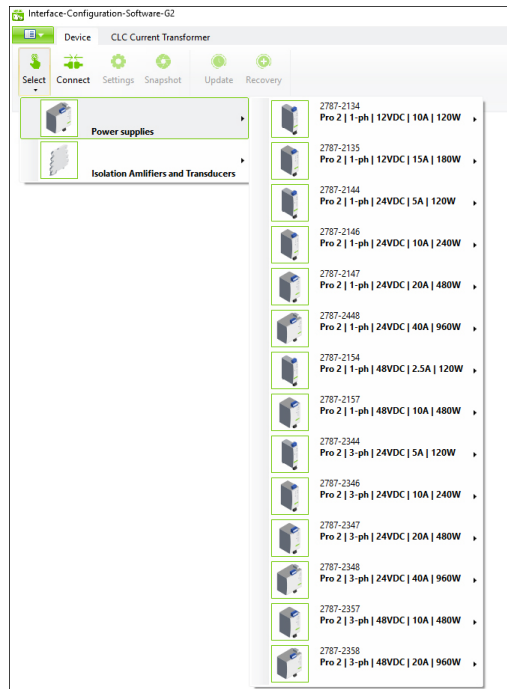

Figure 22: "Device" Tab – "Selection" Menu Item

Only two menu items are initially available on this tab:

Table 51: "Device" Tab

Menu Item	Description
Select	Selects the product to connect to the software.
Connect	Connects the selected product to the software.

The other menu items are not available until you have established the connection between your product and the software (see section [Menu Bar \[▶ 42\]](#)). The **Settings** menu item is an exception; this menu item is available as soon as a product has been manually selected or automatically detected by the software (see the following steps).

The settings you have to make on this tab depend on whether you are configuring your product offline or online:

Offline Configuration

For offline configuration, make the following settings:

1. Select the **Select** menu item.
2. Select the product you use.
 - ⇒ Your product has been set up in the software.

You can now use the software to configure your product offline (see section [Dialog: Settings](#)).

Online Configuration

If your product is already connected to the computer online, you can immediately select the **Connect** menu item. The software automatically detects which product is connected.

Your product is connected to the software. You can now use the software to address, configure and evaluate your product.

10.3 Overview

Once the connection has been successfully established between the product and the software, additional sections appear in the software window.

The following figure provides an overview of all the sections:

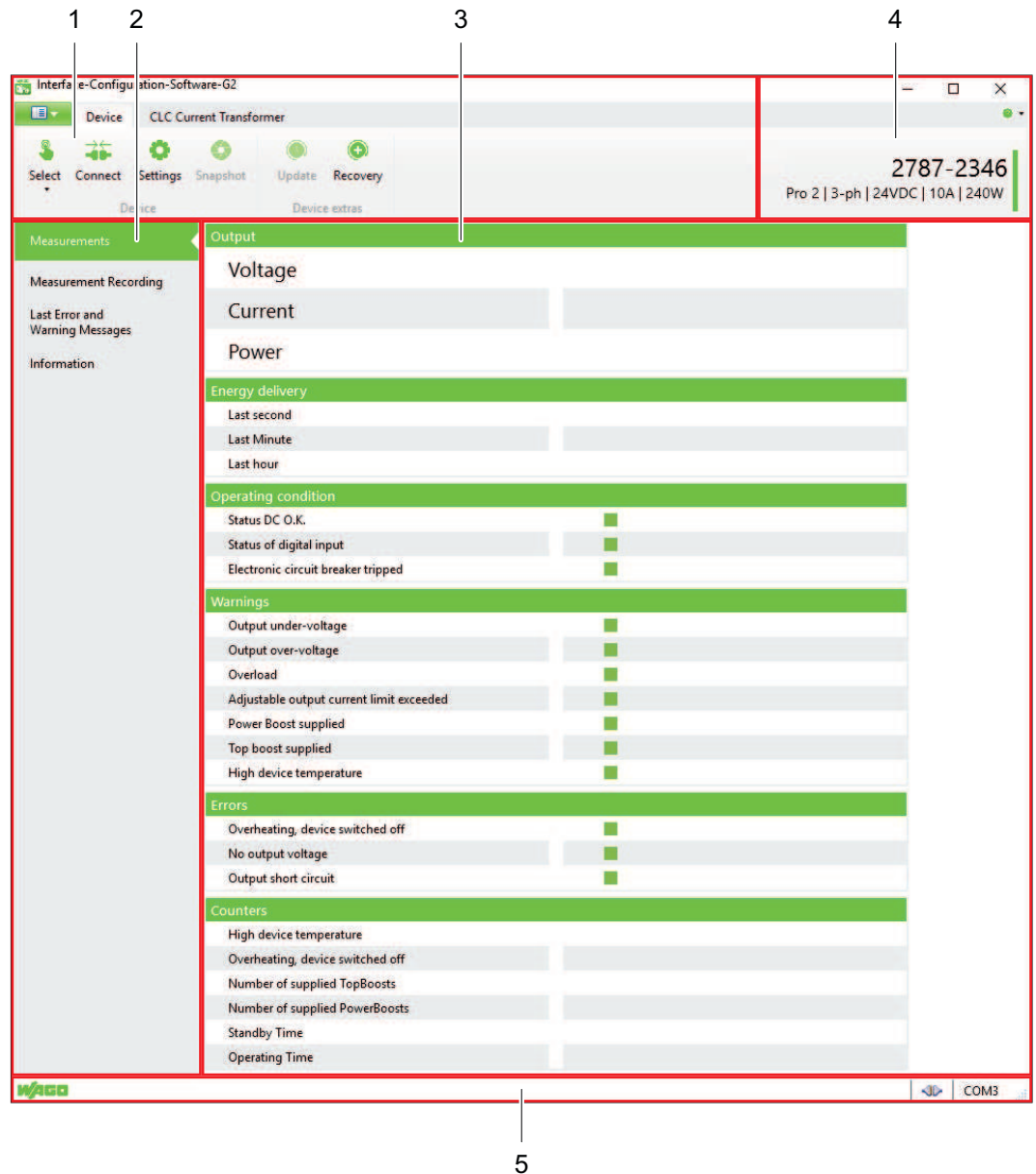

Figure 23: “Graphical User Interface” Overview

Table 52: Legend for the “Graphical User Interface” Overview

Pos.	Section	Description
1	Menu Bar	The menu bar contains general software settings options. You can find more information in section Menu Bar.
2	Main Menu	The main menu contains individual tabs that contain different display sections. You can find more information in section Main Menu.
3	Display Section	The Display section shows parameter settings and recorded time series in graphical form. You can find more information in section Display Section.
4	Product Information	This section contains information on the connected product.

Pos.	Section	Description
5	Footer	The footer indicates the status and interface of the active connection.

10.3.1 Menu Bar

The menu bar is divided into the “Backstage” and “Device” tabs (see also section [Starting the Software \[▶ 38\]](#)).

10.3.1.1 “Backstage” Tab

The settings options on the “Backstage” tab are described in section [Starting the Software \[▶ 38\]](#).

10.3.1.2 “Device” Tab

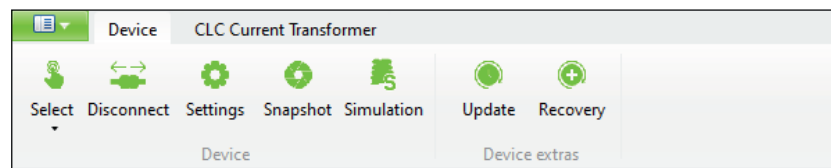

Figure 24: “Device” Tab

Table 53: “Device” Tab

Menu Item	Description
Select	Open the product selection to select a new product (see also section Starting the Software [▶ 38]).
Disconnect Connect	Connects/disconnects the connected product to/from the software
Settings	Opens the “Settings” dialog. The dialog is described in section Dialog: Settings [▶ 42] .
Snapshot	Creates a snapshot of all parameters and measured values, which can be stored as a CSV file.
Simulation	Opens the “Simulation” dialog. The dialog is described in section Dialog: Simulation [▶ 52] .
Update	Performs a firmware update on the product. You can get the current firmware update and corresponding compatibility information from WAGO Technical Support.
Recovery	Restores any firmware version. This may be necessary if a current firmware update has failed and a connection to the connected product cannot be established.

10.3.1.2.1 Dialog: Settings

In this dialog, you can modify settings for the product. Two options are available:

- Online: With this option, the **[Save to device]** button writes the settings directly to the product.
- Offline: With this option, the settings must be saved externally using the **[Export]** button. If a product is connected to the software later on, you can import these settings into the software with the **[Import]** button and then write them directly to the product with the **[Save to device]** button.

The settings can be made in the following sections:

- **DC Output** (see section [↗ DC Output \[▶ 44\]](#))
- **Signalization** (see section [↗ Signalization \[▶ 46\]](#))
- **System** (see section [↗ System \[▶ 48\]](#))
- **Password** (see section [↗ Password \[▶ 50\]](#))
- **Modbus** (see section [↗ Modbus \[▶ 51\]](#))

The buttons apply generally and are identical in all sections.

Buttons



Figure 25: Dialog: Settings – Buttons

Changes that have been made but not yet saved are marked with the pencil symbol.

Table 54: Dialog: Settings – Buttons

Button	Description
[Import]	Imports previously saved settings, e.g., when a product is replaced or configuration is performed offline.
[Export]	Saves the new settings externally. The saved settings can be imported into a product that is configured offline, a replacement product or a product used in a similar way, for example.
[Factory Settings]	Resets all settings to the factory defaults.
[Read from device]	Reads all saved settings from the connected product.
[Save to device]	Writes all the settings that have been made to the connected product.
[Close]	Closes the dialog. Any settings that have not been saved are lost.

The individual sections of the dialog are described below.

DC Output

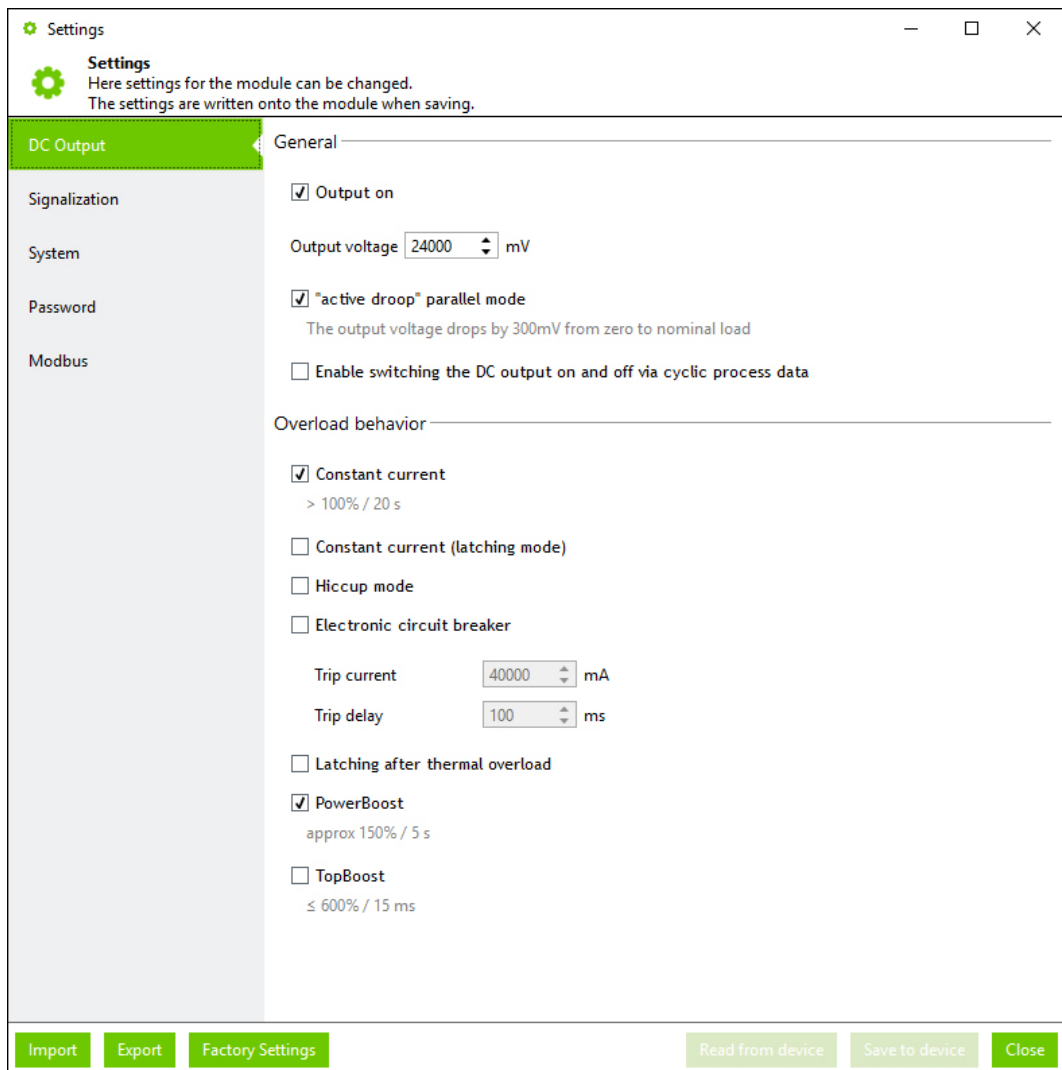

Figure 26: Dialog: Settings – DC Output

Table 55: Dialog: Settings – DC Output

Section	Parameters	Description
General	Output on	If this checkbox is selected, the DC output is activated.
	Output voltage	Here you can enter the output voltage (unit: mV) that is present when the output is active.
	“active droop” parallel mode	If this checkbox is selected, the “Active Droop” parallel switching mode is active. In this mode, a smooth characteristic curve ensures better current sharing for parallel operation of power supplies.
	Enable switching the DC output on and off via cyclic process data	If this checkbox is selected, the DC output can be switched on and off via cyclic process data.
Overload behavior	Constant current	If this checkbox is selected, the “Constant Current” overload behavior is enabled. You can find more information in section “Constant Current” Mode [▶ 65] .
	Constant current (latching mode)	If this checkbox is selected, the “Constant Current with Latching Shutdown” overload behavior is enabled. You can find more information in section “Constant Current with Latching Shutdown” Mode [▶ 65] .

Section	Parameters	Description
	Hiccup mode	If this checkbox is selected, the “Hiccup Mode” overload behavior is enabled. You can find more information in section “Hiccup” Mode [▶ 66] .
	Electronic circuit breaker	If this checkbox is selected, the “Electronic Circuit Breaker” overload behavior is enabled. In the event of overload, the power supply works like an electronic circuit breaker and switches the energy off with a time delay. You can find more information in section “Electronic Circuit Breaker” Mode [▶ 66] .
	Trip current	Here you can enter the trip current (unit: mA) for the “Electronic Circuit Breaker” overload behavior.
	Trip delay	Here you can enter the trip delay (unit: ms) for the “Electronic Circuit Breaker” overload behavior.
	Latching after thermal overload	If this checkbox is selected, the “Latching Shutdown on Thermal Overload” overload behavior is enabled. After an overtemperature event, the power supply no longer automatically switches the output back on as soon as it has cooled off. To switch the output back on, manual intervention is necessary. The following options are available for this: <ul style="list-style-type: none"> • Communication interface • Buttons • Digital input You can find more information in section “Latching Shutdown on Thermal Overload” Mode [▶ 67] .
	PowerBoost	If this checkbox is selected, the “Power Boost” overload behavior is enabled. The power supply offers up to 150 % of the output power for 5 s. You can find more information in section “Power Boost” Mode [▶ 67] .
	TopBoost	If this checkbox is selected, the “Top Boost” overload behavior is enabled. The power supply provides up to 600 % more output power for 15 s. You can find more information in section “Top Boost” Mode [▶ 68] .

Signalization

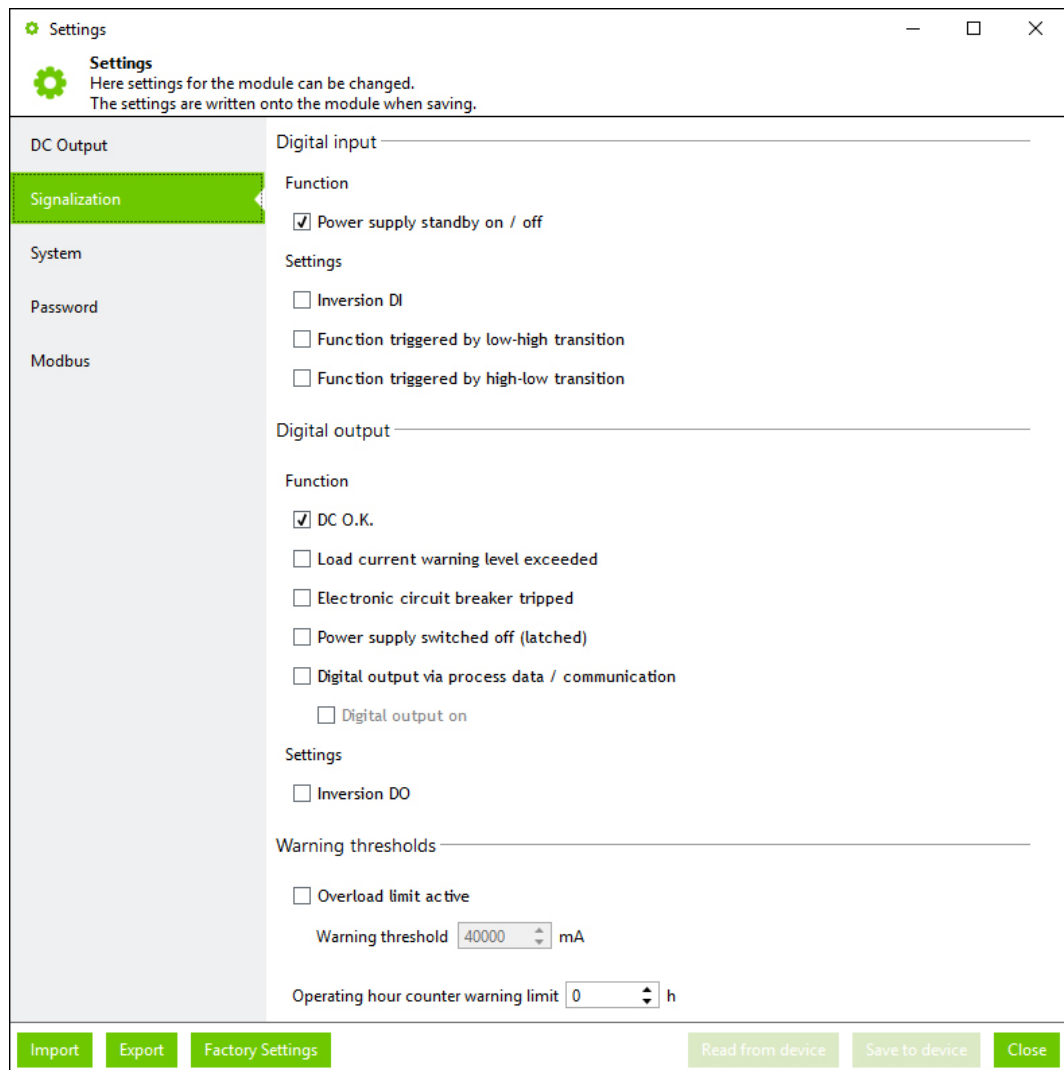

Figure 27: Dialog: Settings – Signalization

Table 56: Dialog: Settings – Signalization

Section	Parameters	Description
Digital input	Power supply standby on/off	If this checkbox is selected, the product can be switched on and off via the digital input.
	Inversion DI	If this checkbox is selected, the digital input is inverted.
	Function triggered by low-high transition	If this checkbox is selected, the digital input is activated in the event of an edge change from 0 to 1.
	Function triggered by high-low transition	If this checkbox is selected, the digital input is activated in the event of an edge change from 1 to 0.
Digital output	DC O.K. ¹⁾	If this checkbox is selected, the digital output is set if the DC output voltage is OK.
	Load current warning level exceeded ¹⁾	If this checkbox is selected, the digital output is set if the overload warning threshold is exceeded.
	Electronic circuit breaker tripped ¹⁾	If this checkbox is selected, the digital output is set if the electronic circuit breaker has tripped.
	Power supply switched off (latched) ¹⁾	If this checkbox is selected, the digital output is set if latching shutdown occurs.
	Digital output via process data/communication ¹⁾	If this checkbox is selected, the digital output can be controlled via the process data.

Section	Parameters	Description
	Digital output on	If this checkbox is selected, the digital output is switched on.
	Inversion DO	If this checkbox is selected, the digital output is inverted.
Warning thresholds	Overload limit active	If this checkbox is selected, a warning is triggered if the overload warning threshold is exceeded.
	Warning threshold	Here you can enter the value for current (unit: mA) at or above which a warning message is generated.
	Operating hour counter warning limit	You can enter after how many operating hours (unit: h) after which a warning message is generated.

¹⁾ These parameters are not mutually exclusive and can also be selected simultaneously.

System

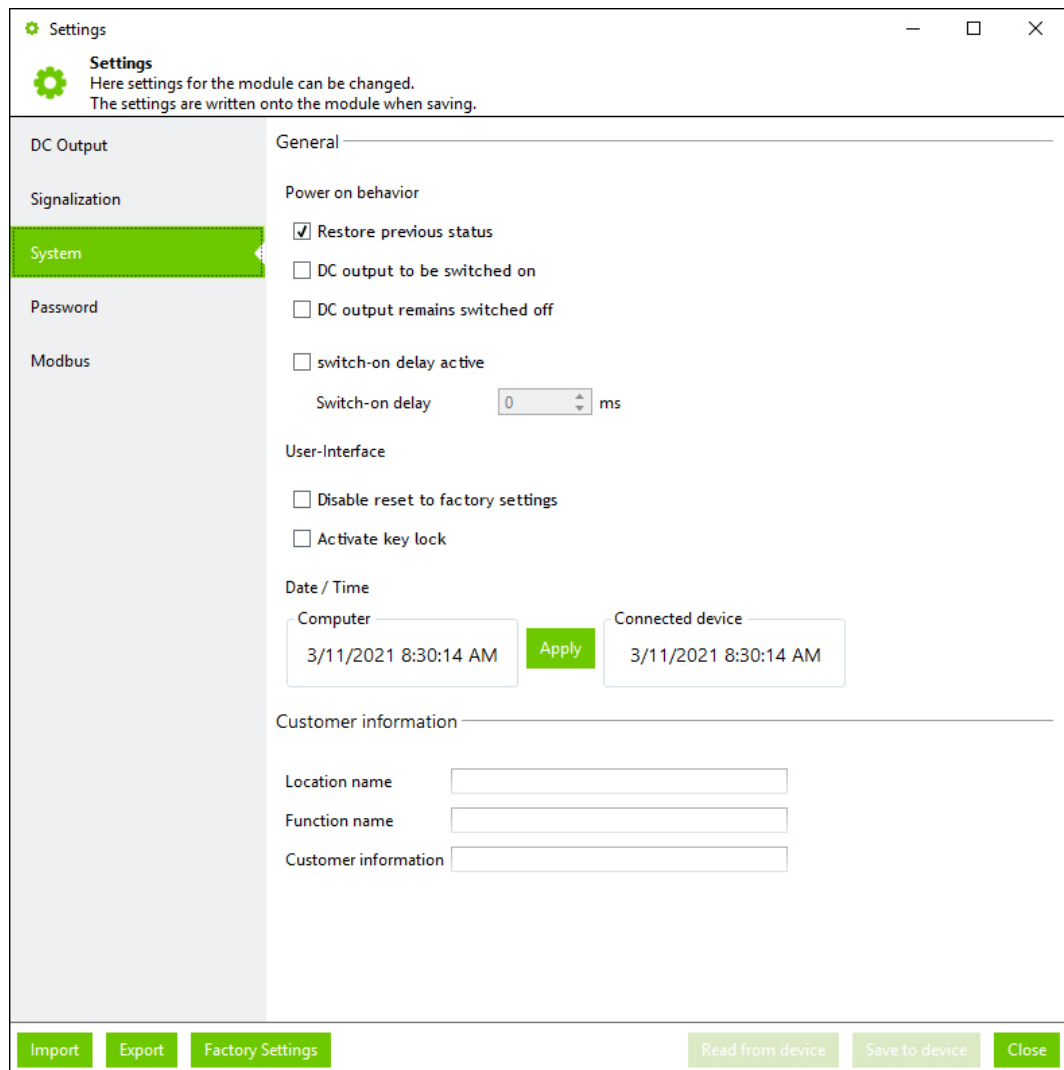

Figure 28: Dialog: Settings – System

Table 57: Dialog: Settings – System

Section	Parameters	Description
General	Restore previous status ¹⁾	If this checkbox is selected, the previous state of the product is restored in the event of connection to the grid.
	DC output to be switched on ¹⁾	If this checkbox is selected, the DC output is switched on in the event of connection to the grid.
	DC output remains switched off ¹⁾	If this checkbox is selected, the DC output remains switched off in the event of connection to the grid.
	Switch-on delay active	If this checkbox is selected, an additional switch-on delay is enabled in the event of connection to the grid.
	Switch-on delay	Here you can enter the switch-on delay (unit: ms).
	Disable reset to factory settings	If this checkbox is selected, it is not longer possible to reset the product to the factory settings using the buttons.
	Activate key lock	If this checkbox is selected, a button lock feature is activated. No functions can be performed with the buttons. However, it is still possible to reset the product to the factory settings.

Section	Parameters	Description
	[Apply]	Here you can synchronize the internal time of the connected product with the system time of the PC.
Customer information	Location name	Here you can enter additional information on the product used. All the input fields can be freely edited. You can enter up to 32 characters into each input field.
	Function name	
	Customer information	

¹⁾ These parameters are mutually exclusive and can only be selected individually.

Password

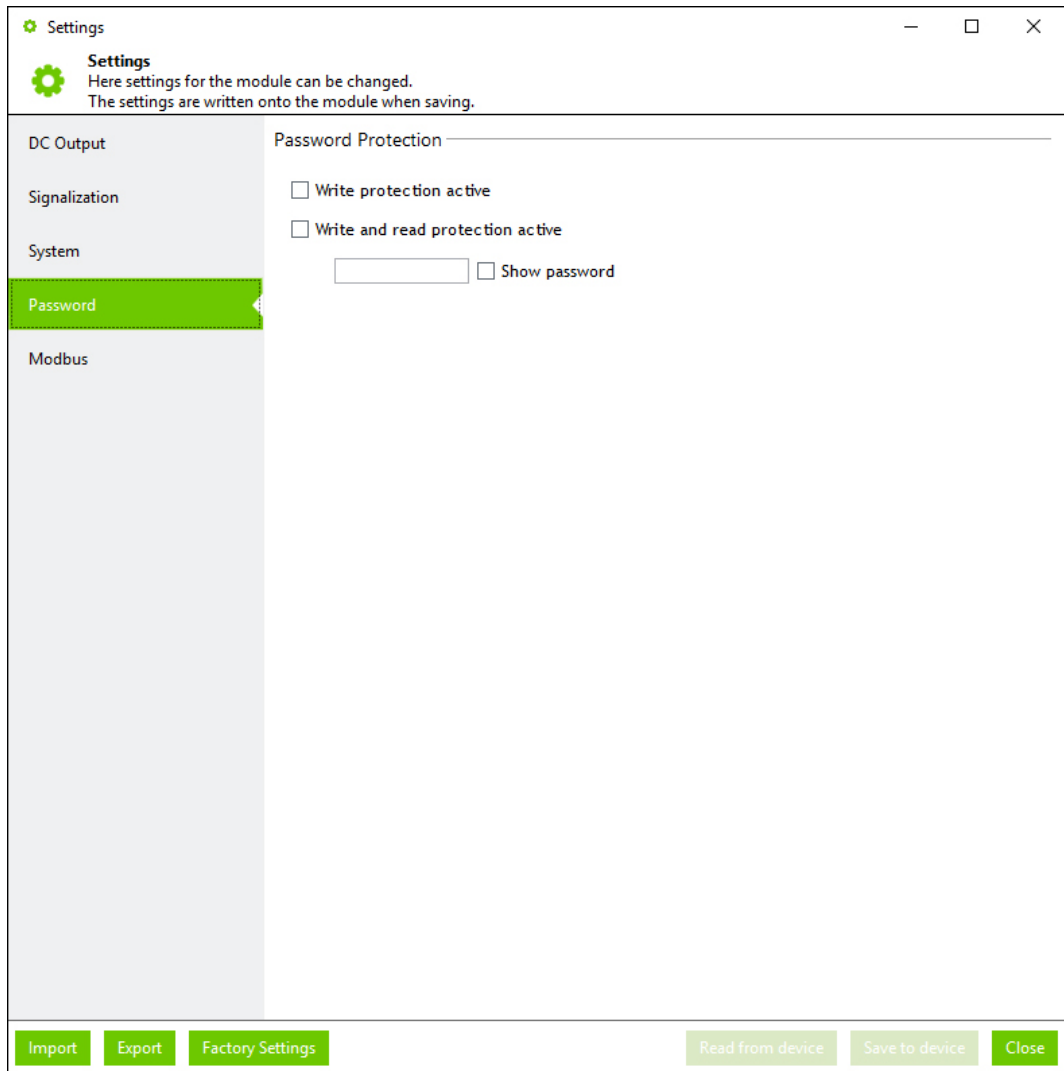

Figure 29: Dialog: Settings – Password

Table 58: Dialog: Settings – Password

Section	Parameters	Description
Password Protection	Write protection active	If this checkbox is selected, no parameters can be written to the product.
	Write and read protection active	If this checkbox is selected, no parameters can be written to the product or read from the product.
	Input field	You can enter the password here. The password can consist of at most eight characters (from the ASCII character set).
	Show password	If this checkbox is selected, the password entered is shown without encryption.

Modbus

This section contains specific parameters for the Modbus RTU Communication Module.

The configured parameters are first transferred to the WAGO Power Supply Pro 2. As soon as the Modbus RTU Communication Module is attached, the parameters are used here accordingly.

More information about the Modbus RTU Communication Module is available in the respective [Product Manual](#) and in section [Accessories – Communication \[▶ 72\]](#).

The screenshot shows a 'Settings' dialog box for the Modbus module. The title bar reads 'Settings' with standard window controls. Below the title bar, there is a gear icon and the text 'Settings Here settings for the module can be changed. The settings are written onto the module when saving.' A sidebar on the left lists categories: DC Output, Signalization, System, Password, and Modbus (highlighted in green). The main content area is titled 'General' and contains the following parameters:

- Device Address: 1
- Response delay: 0 ms
- Baudrate: 19200
- Parity: Even
- Stop bits: 1
- Data format: Middle-Endian

At the bottom of the dialog, there are buttons for 'Import', 'Export', 'Factory Settings', 'Read from device', 'Save to device', and 'Close'.

Figure 30: Dialog: Settings – Modbus

Table 59: Dialog: Settings – Modbus

Section	Parameters	Description
General	Device Address	The device address can be entered here.
	Response delay	The response delay (unit: ms) can be entered here.
	Baudrate	The baud rate can be selected here.
	Parity	The parity can be selected here.
	Stop bits	The number of stop bits can be selected here.
	Data format	The data format can be selected here:

10.3.1.2.2 Dialog: Simulation

In this dialog, you can adjust the individual setting options of a WAGO Power Supply Pro 2 on the software side. No physical WAGO Power Supply Pro 2 is required. The individual setting options are used exclusively for simulation and test purposes and are not transferred to any connected WAGO Power Supply Pro 2.

The simulation has the following advantages:

- **Get to know the full range of functions:**
All existing operating states can be simulated.
- **Visual display of operating states, warnings and errors:**
All operating states, warnings and errors can be displayed visually.
- **Identify the optimal setting options:**
Optimal setting options for a specific load behavior can be identified.
- **View the register of communication models:**
The specific registers and corresponding content of all existing Communication Modules can be viewed.

The dialog is made up of individual areas (“operation panels”) that differ depending on their function. The operation panels themselves have a function-specific structure and can be arranged as desired, highlighted in detail and shown or hidden.

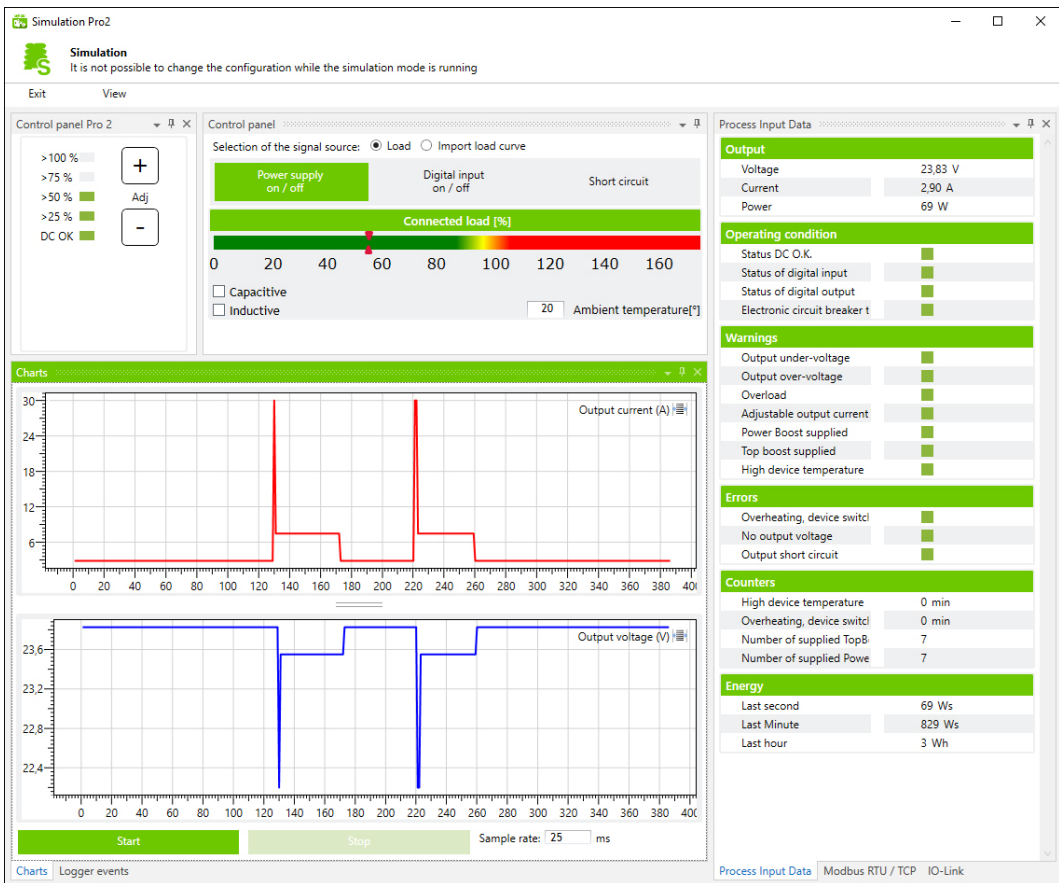



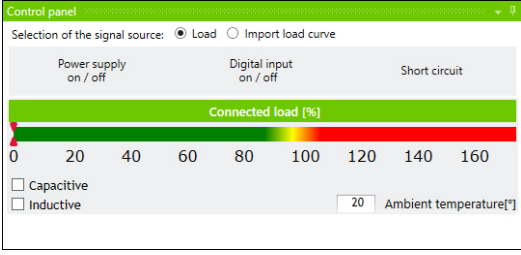

Figure 31: Dialog: Simulation

The dialog is explained below.

Table 60: Dialog: Simulation:

Area	Settings Option	Description
General Setting Options	[Exit]	Closes the dialog.

Area	Settings Option	Description
	[View]	Opens a dialog. You can select the individual operation panels to be displayed in the dialog.
Operation Panel Setting Options		Arranges the selected operation panel depending on the settings in the dialog.
		Hides the selected operation panel and anchors the operation panel as a tab on the outer edge of the dialog.
		Closes the selected operation panel.
"Control panel Pro 2" Operation Panel	Optical Status Indicator	Displays the connected local [unit: %]. You can set the percentage by clicking the [slider control] button in the "Control panel" operation panel.
	[Buttons]	You can set the output voltage. [+] : Increases the output voltage [-] : Decreases the output voltage You can enable the function by clicking the [Power supply on/off] button in the "Control panel" operation panel.
"Control panel" Operation Panel	The operation panel has two different views:	
	<ul style="list-style-type: none"> • "Load" view: This view is displayed if the "Load" setting has been enabled in the Selection of the signal source operation panel. • "Import load curve" view: This view appears if the "Import load curve" setting has been enabled in the Selection of the signal source operation panel. 	
	The different views are locked against each other and can only be selected individually. Individual setting options are also available in both views. These setting options are described in advance.	
	[Power Supply on/off]	Switches the power supply on or off.
	[Digital Input on/off]	Sets the digital input to "1" or resets the digital input to "0".
	[Slider Control]	Sets the load percentage.
	Ambient temperature	You can enter the surrounding air temperature. This function can be used to illustrate how the temperature-dependent load derating of works. Example: The yellow and red areas in the load display shift to the left if an surrounding air temperature in the range +55... +70 ° C is entered. In this way, the temperature-dependent derating is shown visually in the load display according to the surrounding air temperature.
	"Load" View	
Selection of the signal source: Load	If the checkbox is selected, you can set the load percentage by clicking the [slider control] button.	
		
The following specific settings options are available:		

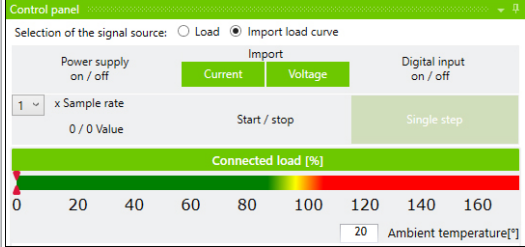
Area	Settings Option	Description
	[Short circuit]	Generates a short circuit.
	Capacitive	If the checkbox is selected, the load has a capacitive component.
	Inductive	If the checkbox is selected, the load has an inductive component.
	"Import Load Curve" View	
	Selection of the signal source: Import load curve	If the checkbox is selected, you can import the load as an external load profile in csv. format.
		
	The following specific settings options are available:	
	[Current]	You can import an existing load profile (current).
	[Voltage]	You can import an existing load profile (voltage).
	Sample rate	You can select the frequency with which the imported load profile should be scanned.
[Start/Stop]	Starts and stops the imported load profile.	
[Single step]	Samples the imported load profile in single steps. Individual points can thus be examined more closely.	
"Process Input Data" Operation Panel	–	Shows operating states, warnings and errors. General information on operating states, warnings and errors is explained in the Section Display Section: Measurements [▶ 56] .
"Modbus RTU/TCP" Operation Panel	–	Shows events and measured values from a plugged-in Modbus RTU Communication Module or a Modbus TCP Communication Module.
"IO-Link" Operation Panel	–	Shows events and measured values from a plugged-in IO-Link Communication Module.
"Charts" Operation Panel		Displays profiles of output voltage and output current. General information on the profiles of measured values is explained in the Section Display Section: Measurement Recording [▶ 58] .
	[Start]	Starts recording.
	[Stop]	Stops recording.
	Sample rate	You can enter the recording cycle for the measured values (unit: ms)
"Logger events" Operation Panel	–	Displays the last accumulated error and warning messages. General information on accumulated error and warning messages is explained in the Section Display Section: Last Error and Warning Messages [▶ 60] .

10.3.2 Main Menu

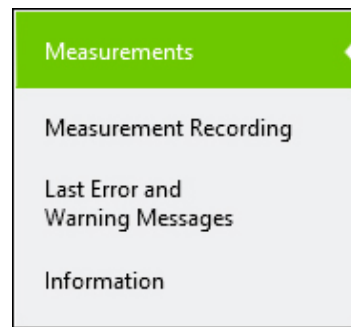

Figure 32: Main Menu

Table 61: Main Menu

Menu Item	Description
Measurements	Shows the current measured values and diagnostic messages. The representation in the display section is described in section Display Section: Measurements.
Measurement Recording	Shows a time sequence graph for up to three measured values. The representation in the Display section is described in section Display Section: Measurement Recording.
Last Error and Warning Messages	Shows the last accumulated error messages and warnings. The representation in the display section is described in section Display Section: Last Error and Warning Messages.
Information	Shows information about the connected product. The representation in the Display section is described in section Display Section: Information.

10.3.3 Display Section

The Display section differs according to the menu item selected in the main menu.

10.3.3.1 Display Section: Measurements

Output	
Voltage	
Current	
Power	
Energy delivery	
Last second	
Last Minute	
Last hour	
Operating condition	
Status DC O.K.	■
Status of digital input	■
Electronic circuit breaker tripped	■
Warnings	
Output under-voltage	■
Output over-voltage	■
Overload	■
Adjustable output current limit exceeded	■
Power Boost supplied	■
Top boost supplied	■
High device temperature	■
Errors	
Overheating, device switched off	■
No output voltage	■
Output short circuit	■
Counters	
High device temperature	
Overheating, device switched off	
Number of supplied TopBoosts	
Number of supplied PowerBoosts	
Standby Time	
Operating Time	

Figure 33: Display Section: "Measurements"

This Display section shows the current operating states, warnings and errors:

Table 62: Display Section: "Measurements"

Section	Indicator	Description
Output	Voltage	This indicates the current output voltage (unit: V).
	Current	This indicates the current output current (unit: A).
	Power	This indicates the current output power (unit: W).
Energy delivery	Last second	This indicates the output energy supplied in the last second (unit: W·s).
	Last minute	This indicates the output energy supplied in the last minute (unit: W·s).
	Last hour	This indicates the output energy supplied in the last hour (unit: W·h).

Section	Indicator	Description
Operating condition	Status DC O.K.	Green indicator: Status OK
	Status of digital input	Red indicator: There is a message
	Electronic circuit breaker tripped	
Warnings	Output under-voltage	Green indicator: Status OK
	Output over-voltage	Red indicator: There is a warning
	Overload	
	Adjustable output current limit exceeded	
	Power Boost supplied ¹⁾	
	Top Boost supplied ¹⁾	
	High device temperature	
Errors	Overheating, device switched off	Green indicator: Status OK
	No output voltage	Red indicator: Error present
	Output short circuit	
Counters	High device temperature	This shows how long the product has been operated at a high device temperature. The displayed value is the sum over the previous operating time (unit: h). The hours themselves are recorded and added up over the entire product life cycle.
	Overheating, device switched off	This shows how long the product switched off due to excess temperature. The displayed value is the sum over the previous operating time (unit: h). The hours themselves are recorded and added up over the entire product life cycle.
	Number of supplied Top Boosts	The number of all Top Boosts generated is displayed here. The displayed value is the sum over the previous operating time.
	Number of supplied Power Boosts	The number of all Power Boosts generated is displayed here. The displayed value is the sum over the previous operating time.
	Standby Time	The standby time of the product (unit: h) is displayed.
	Operating Time	The operating time of the product (unit: h) is displayed.

¹⁾ When Power Boost or Top Boost is output, this is signaled for 5 s.

10.3.3.2 Display Section: Measurement Recording

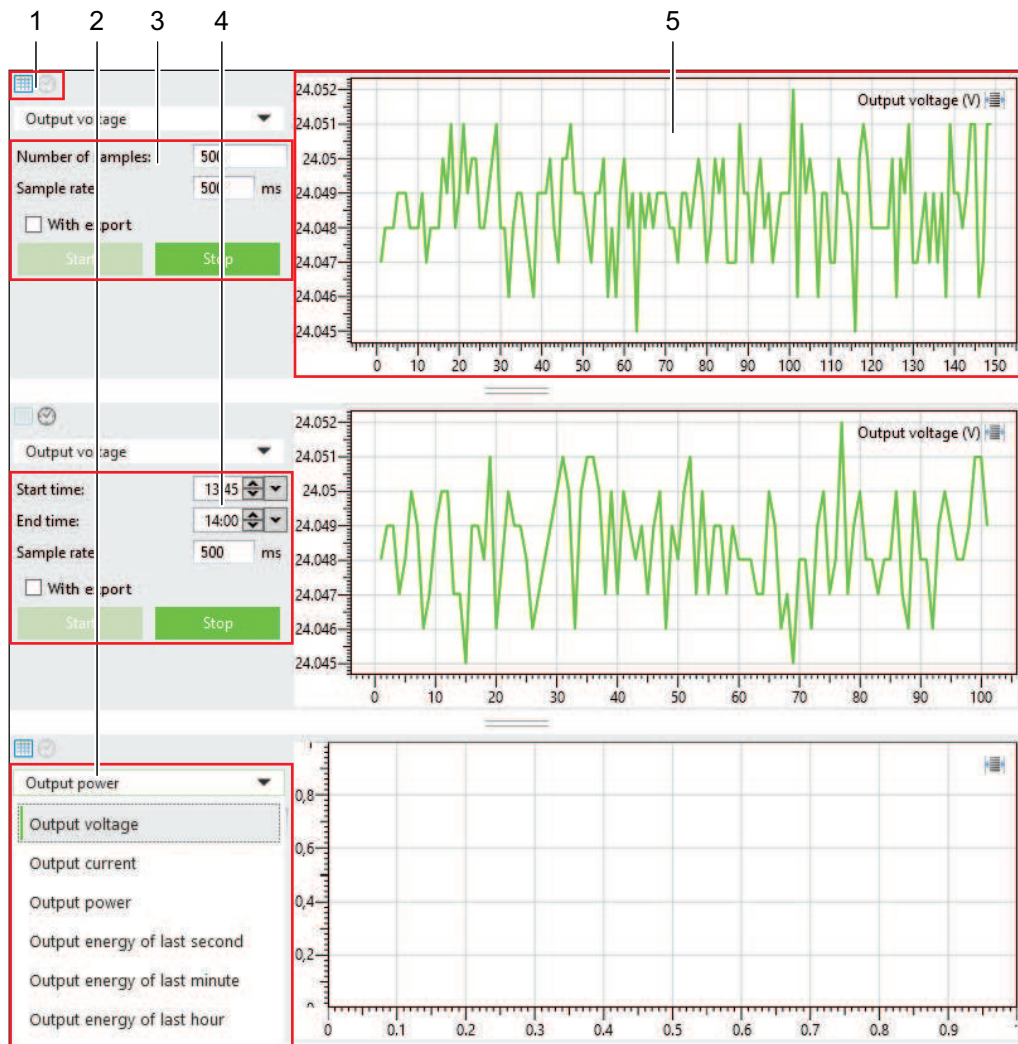

Figure 34: Display Section: "Measurement Recording"

This display section can represent the time series of up to three different measured values (measurement recordings).

You can make the following settings for each time series:

Table 63: Display Section: "Measurement Recording"

Pos.	Setting	Description
1	Chart/Clock	Here you can specify whether a specific number of values (chart) or measured values over a specific time period (clock) should be recorded. The corresponding input form changes accordingly: <ul style="list-style-type: none"> • Pos. 3 = input form for chart • Pos. 4 = input form for clock
2	Measured Value Selection	Here you can select the measured value to record.
3	Number of samples	Here you can enter the number of measured values to record (setting at pos. 1 = chart).
	Sample rate	Here you can enter the recording cycle for the measured values (unit: ms)

Pos.	Setting	Description
	With export	<ul style="list-style-type: none"> Box checked: The recording is exported as a CSV file. Box unchecked: The data is recorded only for on-line display and not saved.
	[Start]	Starts the recording (setting at pos. 1 = chart).
	[Stop]	Stops the recording before the specified number is reached (setting at pos. 1 = chart).
4	Start time	Here you can enter the time when recording should start (setting at pos. 1 = clock).
	End time	Here you can enter the time when recording should end (setting at pos. 1 = clock).
	Sample rate	Here you can enter the recording cycle for the measured values (unit: ms)
	With export	<ul style="list-style-type: none"> Box checked: The recording is exported as a CSV file. Box unchecked: The data is recorded only for on-line display and not saved.
	[Start]	Starts the recording (setting at pos. 1 = chart).
	[Stop]	Stops the recording before the specified number is reached (setting at pos. 1 = chart).
5	–	This shows the time series for the selected measured value.

10.3.3.3 Display Section: Last Error and Warning Messages

No.	Date	Time	WarningCode	ErrorCode
1	2021.03.10	13:02:12	Output under-voltage Adjustable output current limit exceeded Power Boost supplied	Output short circuit
2	2021.03.10	13:02:12	Output under-voltage Adjustable output current limit exceeded Power Boost supplied	
3	2021.03.10	13:02:12	Adjustable output current limit exceeded Power Boost supplied	
4	2021.03.10	13:02:12	Power Boost supplied	
5	2021.03.10	13:02:19		
6		00:00:43	Power Boost supplied	
7		00:00:45		
8	2021.03.10	13:02:06	Top boost supplied	
9	2021.03.10	13:02:06	Output under-voltage	
			Overload	
			Adjustable output current limit exceeded	
10	2021.03.10	13:02:06	Top boost supplied	
			Output under-voltage	
11	2021.03.10	13:02:06	Adjustable output current limit exceeded	Output short circuit
			Top boost supplied	
12	2021.03.10	13:02:06	Output under-voltage	
			Adjustable output current limit exceeded	Output short circuit
			Power Boost supplied	
13	2021.03.10	13:02:06	Top boost supplied	
			Output under-voltage	No output voltage
			Adjustable output current limit exceeded	Output short circuit
14	2021.03.10	13:02:08	Power Boost supplied	
			Top boost supplied	No output voltage
			Output under-voltage	
15	2021.03.10	13:02:08	Adjustable output current limit exceeded	No output voltage
			Power Boost supplied	Output short circuit
			Top boost supplied	

Figure 35: Display Section: "Last Error and Warning Messages"

The last accumulated error messages and warnings are displayed in this display section:

Table 64: Display Section: "Last Error and Warning Messages"

Section	Description
No.	Consecutive number of the accumulated warning and error message.
Date	Date of the accumulated warning and error message.
Time	Time of the accumulated warning and error message.
Warning Code	Text of the accumulated warning.
Error Code	Text of the accumulated error message.

Up to 20 error messages and warnings are shown in the display section.

The display section is a so-called "ring memory": If the display section is full, existing error messages and warnings are overwritten by accumulating error messages and warnings.

10.3.3.4 Display Section: Information

Device information	
Order number:	2787-2346
Description:	Pro 2 3-ph 24VDC 10A 240W
SW-Version:	1.3
HW-Version:	0
Config Id:	00011201 / DS2

Figure 36: Display Section: "Information"

This display section shows information on the connect product.

Table 65: Display Section: "Information"

Indicator	Description
Order number:	This shows the order number of the product.
Description:	This shows the manufacturer's name for the product.
SW-Version	This shows the current release of the software version (firmware).
HW-Version:	This shows the current release of the hardware version.
Config ID:	This shows the configuration ID of the product.

Notes on Operation

11.1 Insulation Testing

Before the electrical system is put into operation, insulation testing must be performed. You can find more detailed information in the following standards, for example:

- DIN VDE 0100-600 VDE 0100-600:2017-06 “Low-voltage electrical installations – Part 6: Verification”
- IEC 60364-6:2016 “Low voltage electrical installations – Part 6: Verification”

To protect the product against damage during this testing, it is necessary to disable the overvoltage protection. You can find more information in section [🔗 Disable/Enable Input-Side Overvoltage Protection \[▶ 62\]](#).

11.2 Disable/Enable Overvoltage Protection

The product is protected against overvoltage (for more information, see section [🔗 Overvoltage Protection \[▶ 29\]](#)).

The letters shown in parentheses refer to positions in the “View” figure in section View.

11.2.1 Disable/Enable Input-Side Overvoltage Protection

Disable Overvoltage Protection

- Remove the screw (j) on the side of the product.
- ⇒ The overvoltage protection is disabled.

Enable Overvoltage Protection

- Screw in the screw (j) on the side of the product.
- ⇒ The overvoltage protection is enabled.

11.2.2 Disable/Enable Output-Side Overvoltage Protection

Disable Overvoltage Protection

- Remove the screw (d) on the side of the product.
- ⇒ The overvoltage protection is disabled.

Enable Overvoltage Protection

- Screw in the screw (d) on the side of the product.
- ⇒ The overvoltage protection is enabled.

11.3 Inrush Current

High inrush currents can occur if multiple products are supplied through the same circuit on the input side. In this case, it is advisable to switch the WAGO Power Supply Pro 2 on with a delay. The corresponding switch-on delay can be parameterized in the Dialog: Settings dialog in the “System” section of the WAGO Interface Configuration software.

The maximum number of products that can be operated in parallel on one circuit is given by the sum of the leakage currents. According to EN 62368-1, this sum must not exceed the maximum value of 3.5 mA.

11.4 Derating

The maximum load is a function of the surrounding air temperature and the installation altitude.

Table 66: Nominal values per UL

Information	Nominal values per UL
IN	400 ... 500 VAC; 0.63 ... 0.5 A; 50 ... 60 Hz
OUT	24 ... 28 VDC SELV; 10 A; 240 W
Ambient temp.	-25 ... +70 °C

Different mounting positions may affect the permissible surrounding air temperature for operation. Please refer to the section [Installation and Removal \[▶ 31\]](#).

11.4.1 Derating (Temperature-Dependent)

Depending on the surrounding air temperature, it may be necessary to reduce the load.

Table 67: Derating (Temperature-Dependent)

Temperature Value	Derating
$T_U > +60\text{ °C}$	-3 %/K (> +60 °C)

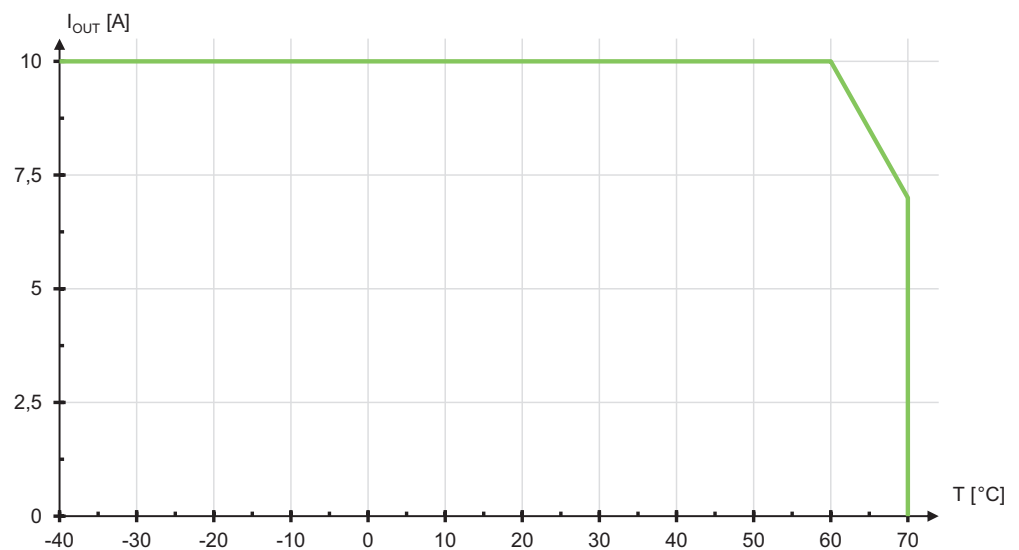

Figure 37: Derating (Temperature-Dependent)

11.4.2 Derating (Location-Dependent)

Depending on the installation altitude and the surrounding air temperature, it may be necessary to reduce the load.

Table 68: Derating (Location-Dependent)

Temperature Value	Derating
$T_U > +60\text{ °C}$	-13.0 %/1000 m (> +60 °C; 2000 m or higher)

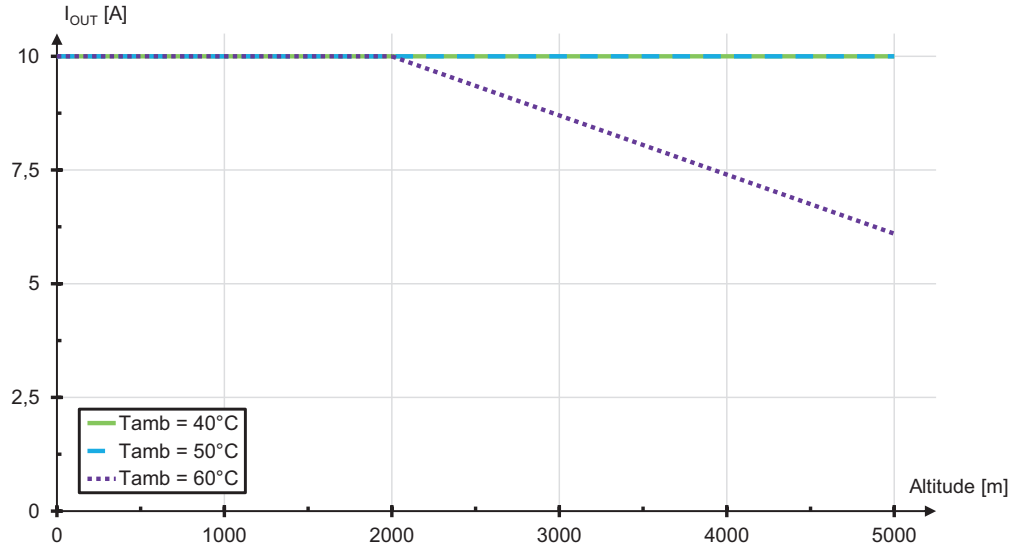

Figure 38: Derating (Location-Dependent)

11.5 Parallel Connection

In parallel operation, set the output voltage of the products that will be connected in parallel to precisely the same value, if possible. The resistance of the conductors between the power supply units and the load must be nearly identical. Only connect products of the same type in parallel.

Use external rail-mount terminal blocks when connecting in parallel. A parallel connection directly on the connectors on the secondary side of the product is not allowed.

For decoupling the outputs in parallel mode, use of diodes in the positive path is recommended. These diodes must be designed for the product’s maximum output current.

For active load distribution, the “Active Droop” setting is enabled by default. This reduces the output voltage in the event of a load (by 300 mV from 0 A up to the nominal current). This smooth characteristic curve ensures better current sharing for parallel operation of power supplies. This setting can be enabled in the Dialog: Settings dialog in the “DC Output” section of the WAGO Interface Configuration software.

11.6 Short-Circuit and Overload Behavior

The product’s output is electronically protected against overload and short circuits.

The following values apply to the description below:

- U_{OUT} : output voltage
- I_{OUT} : output current

- I_N : nominal output current
- I_{ECB} : trip current of the electronic circuit breaker
- t_{ECB} : trip delay of the electronic circuit breaker

You can find more information on the individual values in section Technical Data.

11.6.1 “Constant Current” Mode

In this mode, the load current on the output is limited if the nominal output current is exceeded by a significant amount. The load current is limited to about 110 % of the nominal output current. This occurs for 20 seconds.

If the overload lasts longer, a 15-second pause occurs, during which the output voltage is switched off. The output voltage is then switched back on. If the overload is still present, the process starts again.

This mode is set by default.

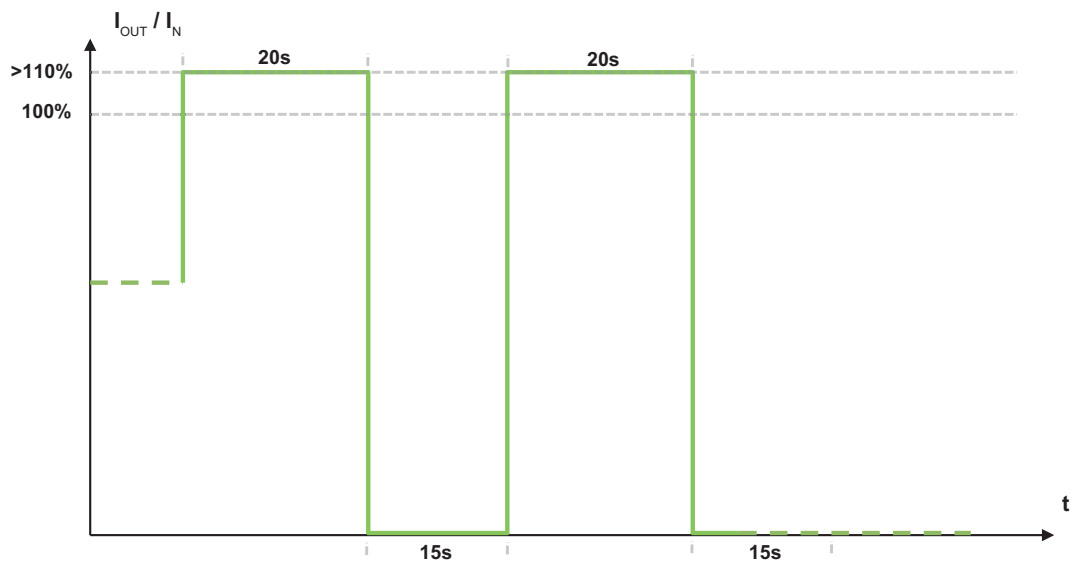

Figure 39: “Constant Current” Mode

11.6.2 “Constant Current with Latching Shutdown” Mode

In this mode, the load current on the output is limited if the nominal output current is exceeded by a significant amount. The load current is limited to about 110 % of the nominal output current. This occurs for 20 seconds.

If the overload lasts longer, the output is switched off. To switch the output back on, manual intervention is necessary. The following options are available for this:

- Communication interface
- Buttons
- Digital input

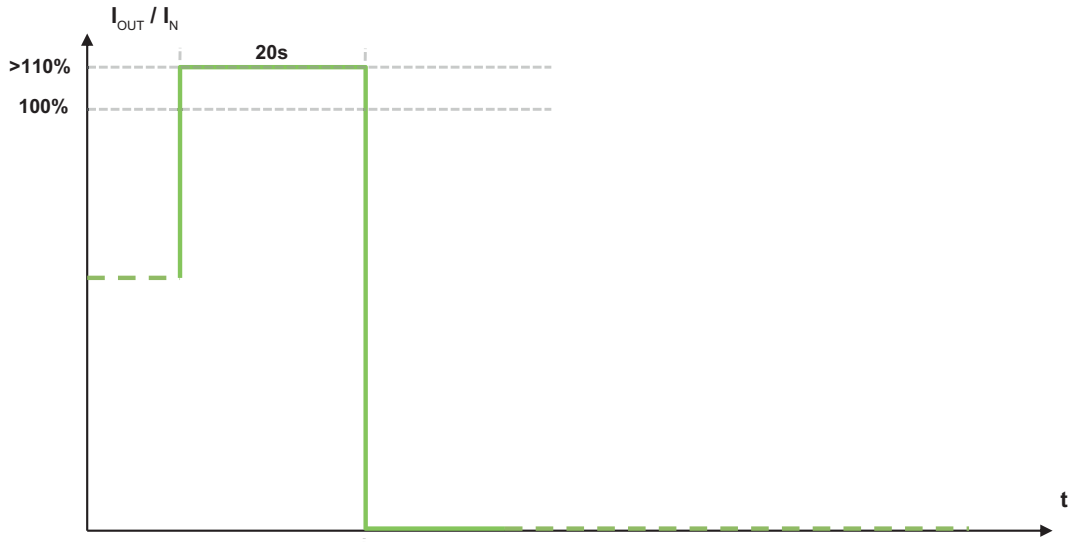

Figure 40: “Constant Current with Latching Shutdown” Mode

11.6.3 “Hiccup” Mode

In this mode, the output voltage is switched off if the nominal output current is exceeded by a significant amount. After a few milliseconds, the output voltage is switched back on to check whether the overload is still present. If the overload is still present, the output voltage is switched back off. This process repeats until the overload has been eliminated.

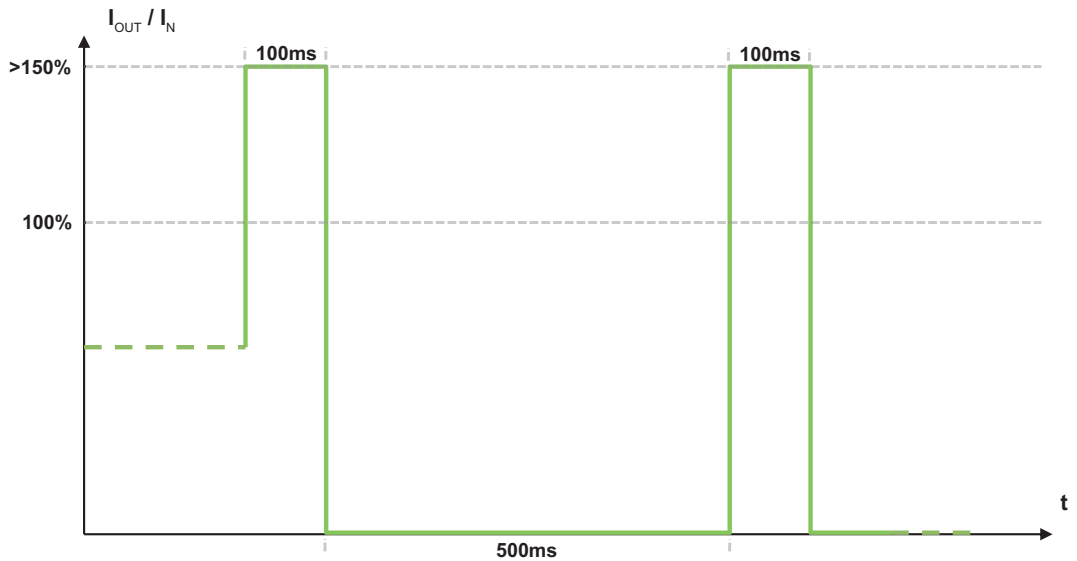



Figure 41: “Hiccup” Mode

11.6.4 “Electronic Circuit Breaker” Mode

In this mode, a specified trip current and trip delay can be set via the WAGO Interface Configuration software or a connected  **communication module [▶ 72]**. If the output current exceeds the trip current setting, a specified amount of time elapses. If the output current is still higher than the trip current setting after the trip delay corresponding to the setting, the output is switched off. To switch the output back on, manual intervention is necessary. The following options are available for this:

- Communication interface
- Buttons

- Digital input

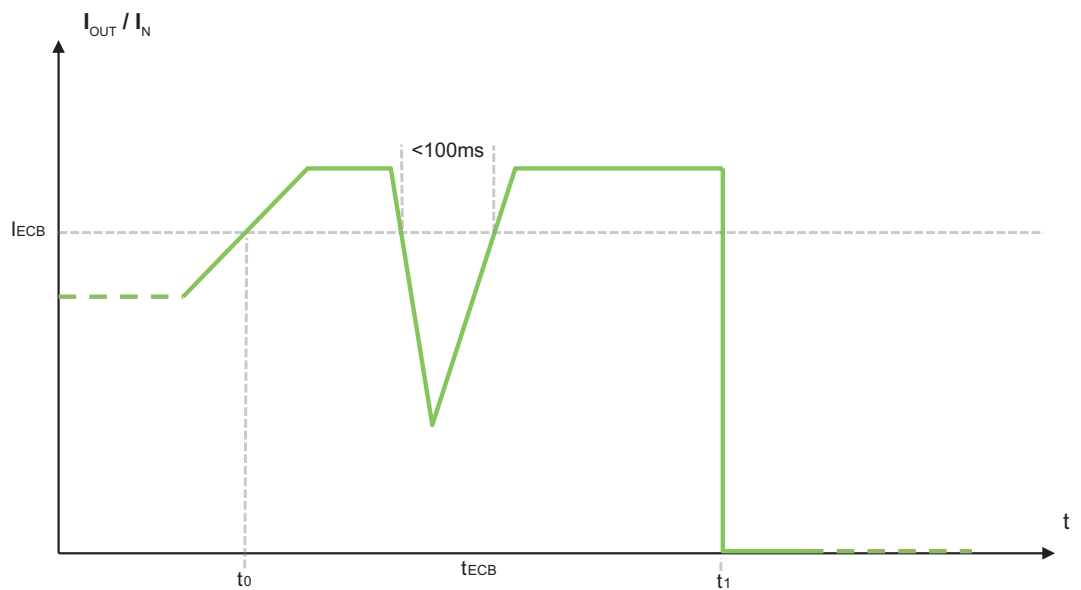



Figure 42: "Electronic Circuit Breaker" Mode



11.6.5 "Latching Shutdown on Thermal Overload" Mode

In this mode, the output voltage is switched off in the event of excessive internal device temperature. A corresponding "High Device Temperature" warning can, for example, be transmitted via the WAGO Interface Configuration software or passed to a higher-level controller via a connected  **communication module [▶ 72]**. To switch the output back on, manual intervention is necessary. The following options are available for this:

- Communication interface
- Buttons
- Digital input

11.6.6 "Power Boost" Mode

This mode can be used in combination with the following modes:

-  **"Constant Current" Mode [▶ 65]**
-  **"Constant Current with Latching Shutdown" Mode [▶ 65]**
-  **"Electronic Circuit Breaker" Mode [▶ 66]**

In this mode, output current equal to 150 % of the nominal output current is permitted for 5 seconds. The output is then switched off. To switch the output back on, manual intervention is necessary. The following options are available for this:

- Communication interface
- Buttons
- Digital input

In combination with the  **"Constant Current" Mode [▶ 65]**, the "Power Boost" Mode is activated again after each pause.

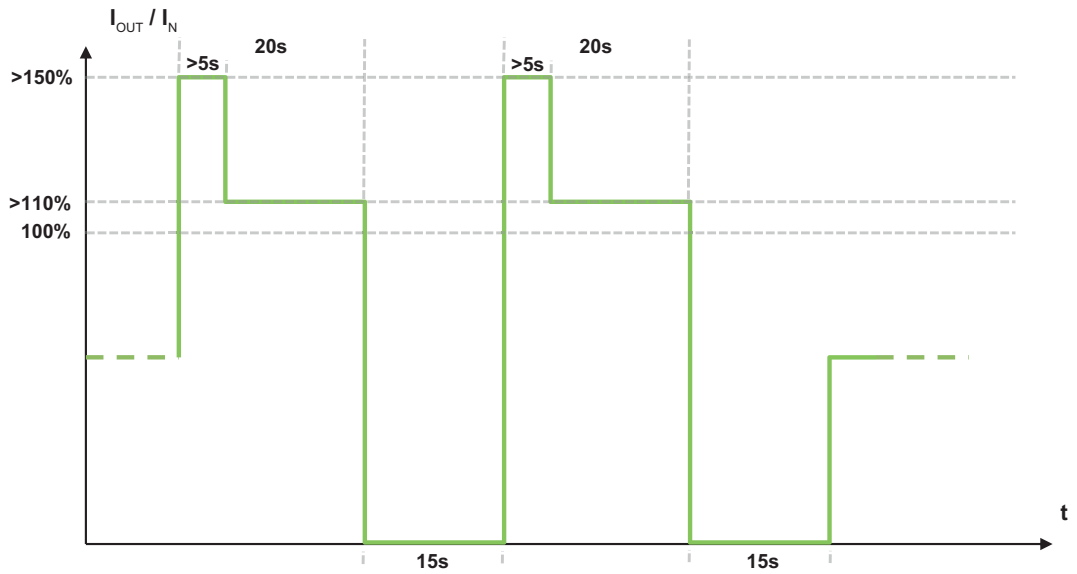

Figure 43: "Power Boost" Mode in Combination with "Constant Current" Mode

11.6.7 "Top Boost" Mode

In this mode, a current pulse of up to 600 % is output for up to 15 ms if the current output current exceeds the nominal output current by a significant amount. This overcurrent can be caused by a short circuit or a large overload in the secondary circuit, for example.

In some cases, the current pulse can trip an overcurrent protection device that is present in the connected circuit, such as a circuit breaker. This quickly ends the short circuit or high overload.

In selecting an appropriate overcurrent protection device, it is essential to pay attention to the following technical data to ensure reliable tripping:

- Trip characteristics
- Nominal value
- Safety factor for DC tripping

In addition, calculate the error loop impedance. The maximum current that can flow through the error loop (due to the impedance) must not be lower than trip current of the overcurrent protection device necessary to reliably trip it.

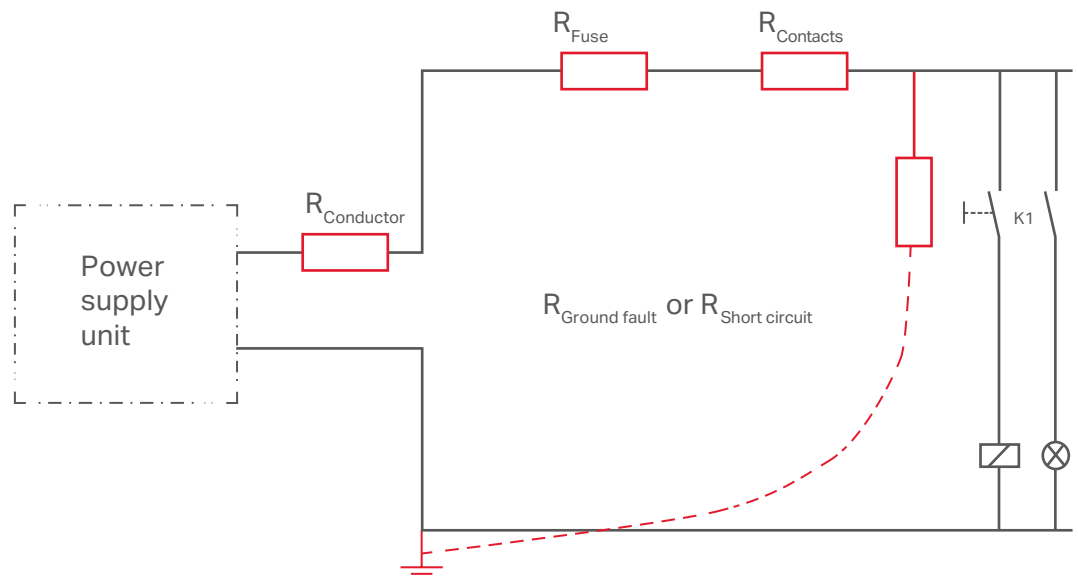

Figure 44: Loop Impedance

Note

Using “Power Boost” and “Top Boost” Modes Together

With firmware version 01.04.xx or higher, the “Power Boost” and “Top Boost” modes can be used together. You can get a current firmware update from WAGO Technical Support.

11.7 Maintenance

Note

Observe the following for long-term storage:

For long-term storage, power must be applied to equipment with built-in capacitors for five minutes at least every two years.

The product requires no special maintenance; however it must be protected (as per the protection class) against dust accumulation, moisture, radiation and aggressive chemicals.

Permitted repairs are limited to the measures listed in these operating instructions.

Should a fault occur nonetheless, return the product to WAGO for repair. Provide the following information:

- Type of fault
- Circumstances (operating conditions, input wiring)
- Your suspicion about the fault’s cause
- Previous instances of unusual incidents etc.

The convenient, standardized and therefore faster RMA process is available for returns and reports of defects. The corresponding report form for returns and reports of defects is available at <https://www.wago.com/us/ruecksendungen-reklamationen>.

Decommissioning

12.1 Disposal and Recycling

Table 69: WEEE Mark

Logo	Description
	Electrical and electronic equipment may not be disposed of with household waste. This also applies to products without this mark.

Electrical and electronic equipment contain materials and substances that can be harmful to the environment and health. Electrical and electronic equipment must be disposed of properly after use. Environmentally friendly disposal benefits health, protects the environment from harmful substances in electrical and electronic equipment and enables sustainable and efficient use of resources.

- Observe national and local regulations for the disposal of batteries, packaging and electrical and electronic equipment.
- Clear any data stored on electrical and electronic equipment.
- Remove any batteries or memory cards installed in electrical and electronic equipment.
- Dispose of all types of packaging to ensure a high level of recovery, reuse and recycling.
- Have electrical and electronic equipment sent to a local collection point.
- The guidelines 2006/66/EG, PPWD 2018/852/EU and WEEE 2012/19/EU apply throughout Europe. National directives and laws may vary.

Appendix

13.1 Application Notes

The following figures illustrate examples of how a WAGO Power Supply Pro 2 can be connected as a consumer in three different grounding systems: TN, TT and IT.

13.1.1 AC Operation

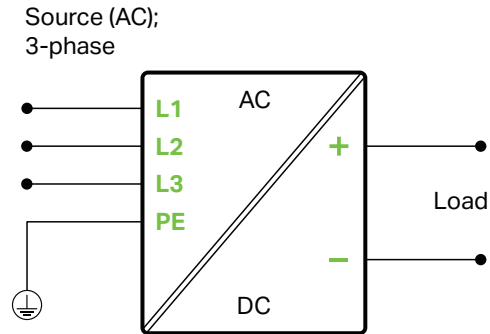

Figure 45: AC input

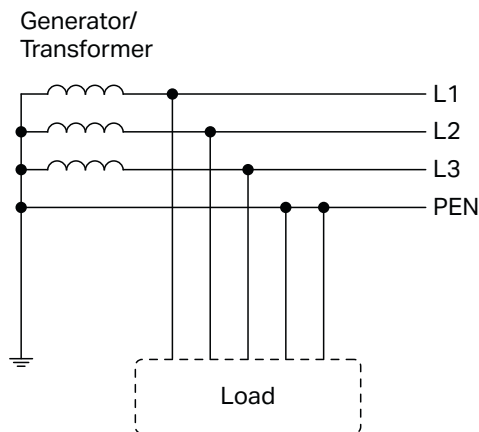

Figure 46: TN Network

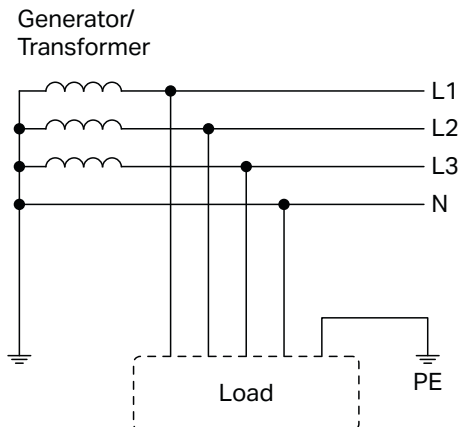

Figure 47: TT Network

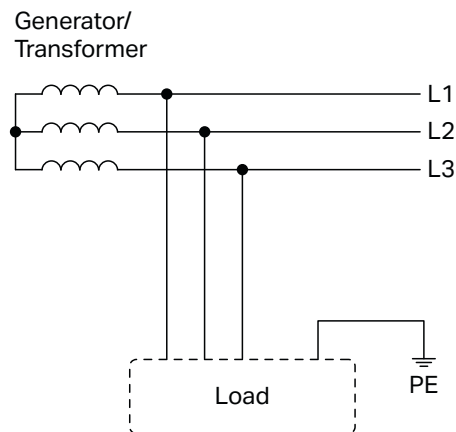

Figure 48: IT Network

13.2 Accessories

The following accessories are available for the product:

Accessories – Communication

Table 70: Accessories – Communication

Description	Designation	Item number
Attachable IO-Link Communication Module for WAGO Power Supply Pro 2	IO-Link Communication Module	2789-9080
Attachable Modbus RTU Communication Module for WAGO Power Supply Pro 2	Modbus RTU Communication Module	2789-9015
Attachable Modbus TCP Communication Module for WAGO Power Supply Pro 2	Modbus TCP Communication Module	2789-9052
Attachable EtherNet/IP Communication Module for WAGO Power Supply Pro 2	EtherNet/IP Communication Module	2789-9023
WAGO USB Communication Cable	2.5 m	0750-0923

Accessories – Tools

Table 71: Accessories – Tools

Description	Designation	Item Number
Operating tool, with partially insulated shaft	Type 2, blade 3.5 × 0.5 mm	0210-0720
Operating tool, with partially insulated shaft	Type 3, blade 5.5 × 0.8 mm	0210-0721

Accessories – Marking

Table 72: Accessories – Marking

Description	Designation	Item Number
Marker Carrier	-	2789-1233
Marking System	-	2009-0110
WMB Multi Marking System	-	2009-0115
	-	2009-0115/0000-0002

Accessories – Spare Parts

Table 73: Accessories – Spare Parts

Description	Item Number
Female connector as spare part, input	0721-0099/0000-0003

Description	Item Number
Female connector as spare part, output	0721-0105/0000-0015/0000-9504
Female connector as spare part, signal	0721-0104/K000-0001

13.3 Protected Rights

- Adobe® and Acrobat® are registered trademarks of Adobe Systems Inc.
- Android™ is a trademark of Google LLC.
- Apple, the Apple logo, iPhone, iPad and iPod touch are registered trademarks of Apple Inc. registered in the USA and other countries. “App Store” is a service mark of Apple Inc.
- AS-Interface® is a registered trademark of the AS-International Association e.V.
- BACnet® is a registered trademark of the American Society of Heating, Refrigerating and Air Conditioning Engineers, Inc. (ASHRAE).
- Bluetooth® is a registered trademark of Bluetooth SIG, Inc.
- CiA® and CANopen® are registered trademarks of CAN in AUTOMATION – International Users and Manufacturers Group e.V.
- CODESYS is a registered trademark of CODESYS Development GmbH.
- DALI is a registered trademark of the Digital Illumination Interface Alliance (DiiA).
- EtherCAT® is a registered trademark and patented technology licensed by Beckhoff Automation GmbH, Germany.
- ETHERNET/IP™ is a registered trademark of the Open DeviceNet Vendor Association, Inc (ODVA).
- EnOcean® is a registered trademark of EnOcean GmbH.
- Google Play™ is a registered trademark of Google Inc.
- IO-Link is a registered trademark of PROFIBUS Nutzerorganisation e.V.
- KNX® is a registered trademark of the KNX Association cvba.
- Linux® is a registered trademark of Linus Torvalds.
- LON® is a registered trademark of the Echelon Corporation.
- Modbus® is a registered trademark of Schneider Electric, licensed for Modbus Organization, Inc.
- OPC UA is a registered trademark of the OPC Foundation.
- PROFIBUS® is a registered trademark of the PROFIBUS Nutzerorganisation e.V. (PNO).
- PROFINET® is a registered trademark of the PROFIBUS Nutzerorganisation e.V. (PNO).
- QR Code is a registered trademark of DENSO WAVE INCORPORATED.
- Subversion® is a trademark of the Apache Software Foundation.
- Windows® is a registered trademark of Microsoft Corporation.

List of Tables

Table 1	Scope of Applicability.....	6
Table 2	Complete instructions for use	6
Table 3	Legend for Figure “View”	12
Table 4	Legend for Figure “Type label”.....	13
Table 5	Legend for Figure “Label”	14
Table 6	Revision index structure.....	14
Table 7	Legend for Figure “Input X1 Connection”.....	15
Table 8	Details – Input Connection.....	15
Table 9	Legend for Figure “Output X2 Connection”.....	15
Table 10	Details – Output Connection	15
Table 11	Legend for Figure “Signal X3 Connection”.....	16
Table 12	Details – Signal Connection.....	16
Table 13	Indication of Operating States – General.....	16
Table 14	Indication of Operating States – Output Power.....	16
Table 15	Technical Data – Product.....	18
Table 16	Technical Data – AC Input.....	19
Table 17	Technical Data – Inrush Current.....	19
Table 18	Technical Data – Mains Failure Buffering Time	19
Table 19	Technical Data – Input Connection.....	19
Table 20	Technical Data – Output	19
Table 21	Technical Data – Output Connection	20
Table 22	Technical Data – Efficiency/Power Loss.....	21
Table 23	Technical Data – Signal (Input DI).....	22
Table 24	Technical Data – Signal (Output DO)	22
Table 25	Technical Data – Signal Connection.....	22
Table 26	Technical Data – Communication	22
Table 27	Technical Data – MTBF/Lifespan.....	22
Table 28	Technical Data – Environmental Conditions	23
Table 29	Technical Data – Product Protection	23
Table 30	Technical Data – Safety.....	24
Table 31	Guidelines	24
Table 32	Approvals.....	24
Table 33	Standards: Mechanical and Climatic Environmental Conditions.....	25
Table 34	Standards: EMC – Immunity to Interference.....	25
Table 35	Standards: EMC – Emission of Interference.....	26
Table 36	Standards: LVD – Low Voltage Directive.....	26

Table 37	Standards: EMC – Immunity to Interference (Tests Performed).....	26
Table 38	Legend for “Standards: EMC – Immunity to Interference (Tests Performed)”	27
Table 39	Standards: EMC – Emission of Interference (Tests Performed).....	27
Table 40	Functions	29
Table 41	Test voltages on the input side	29
Table 42	Test voltages on the output side	29
Table 43	Minimum Clearances	31
Table 44	Operation via Buttons	35
Table 45	Display of Diagnostics – Warnings	36
Table 46	Diagnostic Indicators – Errors.....	36
Table 47	Minimum System Requirements	37
Table 48	Recommended System Requirements	37
Table 49	Legend for Figure “Start View – Tabs”	39
Table 50	“Backstage” Tab.....	39
Table 51	“Device” Tab	40
Table 52	Legend for the “Graphical User Interface” Overview	41
Table 53	“Device” Tab	42
Table 54	Dialog: Settings – Buttons.....	43
Table 55	Dialog: Settings – DC Output.....	44
Table 56	Dialog: Settings – Signalization	46
Table 57	Dialog: Settings – System.....	48
Table 58	Dialog: Settings – Password	50
Table 59	Dialog: Settings – Modbus	51
Table 60	Dialog: Simulation:	52
Table 61	Main Menu	55
Table 62	Display Section: “Measurements”	56
Table 63	Display Section: “Measurement Recording”	58
Table 64	Display Section: “Last Error and Warning Messages”	60
Table 65	Display Section: “Information”	61
Table 66	Nominal values per UL.....	63
Table 67	Derating (Temperature-Dependent).....	63
Table 68	Derating (Location-Dependent).....	64
Table 69	WEEE Mark	70
Table 70	Accessories – Communication.....	72
Table 71	Accessories – Tools.....	72
Table 72	Accessories – Marking.....	72
Table 73	Accessories – Spare Parts.....	72

List of Figures

Figure 1	View	12
Figure 2	Type label.....	13
Figure 3	Label	14
Figure 4	Input X1 Connection	15
Figure 5	Output X2 Connection.....	15
Figure 6	Signal X3 Connection	16
Figure 7	Optical Status Indicator.....	16
Figure 8	Control elements	17
Figure 9	Dimensions	18
Figure 10	Turn-on Time.....	20
Figure 11	Efficiency (typ.) at 400 VAC	21
Figure 12	Power loss (typ.) at 400 VAC	21
Figure 13	Dielectric Strength.....	24
Figure 14	Position of the DIN-35 rail	31
Figure 15	Mounting	32
Figure 16	Removing.....	32
Figure 17	Connect Conductor to CAGE CLAMP®.....	34
Figure 18	Software Start	38
Figure 19	Start View.....	38
Figure 20	Start View – Tabs.....	38
Figure 21	“Backstage” Tab.....	39
Figure 22	“Device” Tab – “Selection” Menu Item	40
Figure 23	“Graphical User Interface” Overview.....	41
Figure 24	“Device” Tab.....	42
Figure 25	Dialog: Settings – Buttons.....	43
Figure 26	Dialog: Settings – DC Output.....	44
Figure 27	Dialog: Settings – Signalization	46
Figure 28	Dialog: Settings – System	48
Figure 29	Dialog: Settings – Password	50
Figure 30	Dialog: Settings – Modbus	51
Figure 31	Dialog: Simulation	52
Figure 32	Main Menu	55
Figure 33	Display Section: “Measurements”	56
Figure 34	Display Section: “Measurement Recording”	58
Figure 35	Display Section: “Last Error and Warning Messages”	60
Figure 36	Display Section: “Information”	61

Figure 37	Derating (Temperature-Dependent).....	63
Figure 38	Derating (Location-Dependent).....	64
Figure 39	“Constant Current” Mode	65
Figure 40	“Constant Current with Latching Shutdown” Mode	66
Figure 41	“Hiccup” Mode.....	66
Figure 42	“Electronic Circuit Breaker” Mode	67
Figure 43	“Power Boost” Mode in Combination with “Constant Current” Mode	68
Figure 44	Loop Impedance	69
Figure 45	AC input	71
Figure 46	TN Network	71
Figure 47	TT Network.....	71
Figure 48	IT Network.....	72

WAGO GmbH & Co. KG

Postfach 2880 · D - 32385 Minden
Hansastraße 27 · D - 32423 Minden

✉ info@wago.com
🌐 www.wago.com

Headquarters	+49 571/887 – 0
Sales	+49 (0) 571/887 – 44 222
Order Service	+49 (0) 571/887 – 44 333
Fax	+49 571/887 – 844169