

# Communication Modules

Modbus RTU Communication Module

2789-9015



© 2020 WAGO Kontakttechnik GmbH & Co. KG  
All rights reserved.

**WAGO Kontakttechnik GmbH & Co. KG**

Hansastraße 27  
D - 32423 Minden

Phone: +49 571/887 – 0  
Fax: +49 571/887 – 844169  
E-Mail: ✉ [info@wago.com](mailto:info@wago.com)  
Internet: 🌐 [www.wago.com](http://www.wago.com)

**Technical Support**

Phone: +49 571/887 – 44555  
Fax: +49 571/887 – 844555  
E-Mail: ✉ [support@wago.com](mailto:support@wago.com)

Every conceivable measure has been taken to ensure the accuracy and completeness of this documentation. However, as errors can never be fully excluded, we always appreciate any information or suggestions for improving the documentation.

E-Mail: ✉ [documentation@wago.com](mailto:documentation@wago.com)

We wish to point out that the software and hardware terms as well as the trademarks of companies used and/or mentioned in the present manual are generally protected by trademark or patent.

**WAGO is a registered trademark of WAGO Verwaltungsgesellschaft mbH.**

# Table of Contents

<b>Provisions</b> .....	<b>5</b>
1.1 Intended Use.....	5
1.2 Typographical Conventions.....	6
1.3 Legal Information .....	8
<b>Security</b> .....	<b>9</b>
2.1 General Safety Rules .....	9
2.2 Electrical Safety.....	9
2.3 Mechanical Safety .....	9
2.4 Thermal Safety .....	10
2.5 Indirect Safety .....	10
<b>Properties</b> .....	<b>11</b>
3.1 Introduction.....	11
3.2 View.....	11
3.3 Type label.....	12
3.4 Product-specific information .....	12
3.5 Connections .....	13
3.5.1 RJ-45 Interfaces .....	13
3.6 Indicators.....	13
3.7 Technical data.....	14
3.7.1 Product .....	14
3.7.2 Power Loss.....	14
3.7.3 Communication .....	14
3.7.4 Environmental Conditions .....	14
3.8 Guidelines, approvals and standards .....	15
3.8.1 Guidelines .....	15
3.8.2 Approvals .....	15
3.8.3 Standards .....	15
3.8.4 Special Requirements .....	16
<b>Fieldbus Description</b> .....	<b>17</b>
4.1 Technology.....	17
4.1.1 Topology.....	17
4.1.2 Addressing .....	17
4.1.3 Manual Addressing of a Subordinate WAGO Power Supply Pro 2 .....	17
4.1.4 Cables .....	19
4.1.5 Function Codes .....	19
4.1.6 Exception Codes .....	20
4.2 Module Parameters .....	20
4.2.1 General Module Parameters .....	20
4.2.2 Specific Module Parameters of the WAGO Power Supply Pro 2 .....	22
4.3 Messages and Events.....	25

---

4.3.1	Events and Measured Values for WAGO Power Supply Pro 2 .....	25
	<b>Transport and Storage.....</b>	<b>27</b>
	<b>Installation and Removal.....</b>	<b>28</b>
	<b>Connection .....</b>	<b>30</b>
7.1	Connect.....	30
	<b>Decommissioning .....</b>	<b>31</b>
8.1	Disposal and Recycling .....	31
	<b>Appendix.....</b>	<b>32</b>
9.1	Accessories .....	32
9.2	Protected Rights.....	32

# Provisions

This documentation applies to Modbus RTU Communication Module (2789-9015).

## Note

### Observe the applicable documentation!

This product must only be installed and operated according to the instructions of the complete Instructions for use. Knowledge of the complete Instructions for use is required for proper use.

1. Carefully read the Product Manual.
2. Before commissioning, follow the instructions in section  **Safety [▶ 9]**.

Table 1: Complete instructions for use





Document Type	Contents
 Product Manual	Contains all the product-specific information for a product.
 Instruction leaflet	Is included with each product. Contains initial information on safe handling of the product.

Table 2: Additional documentation

Document Type	Contents
 Product Manual	WAGO Power Supply Pro 2
 Instruction leaflet	WAGO Power Supply Pro 2

All the documentation is available at:  [www.wago.com](http://www.wago.com).

## 1.1 Intended Use

The product is an open system and is designed for installation in a additional enclosure.

- This product is intended for installation in automation technology systems.
- This product fulfills the requirements of protection type IP20 and is designed for use in dry indoor spaces.
- Operation of the products in Industrial area is permitted.
- The product meets the EMC requirements for Residential, businesses and commercial areas; small businesses too. if the product used complies with the emission of interference requirements (emission limits).
- Operation of the product in other application areas is only permitted when corresponding approvals and labeling are present.

### Improper Use

Improper use of the product is not permitted. Improper use occurs especially in the following cases:

- Non-observance of the intended use.
- Use without additional protective measures in environments within which dust, corrosive fumes, gases or ionized radiation can occur.

- Use of the product in areas with special risk that require continuous fault-free operation and in which failure of or operation of the product can result in an imminent risk to life, limb or health or cause serious damage to property or the environment (such as the operation of nuclear power plants, weapons systems, aircraft and motor vehicles).

### Warranty and Liability

The terms set forth in the General Business & Contract Conditions for Delivery and Service of WAGO Kontakttechnik GmbH & Co. KG and the terms for software products and products with integrated software stated in the WAGO Software License Contract – both available at [www.wago.com](http://www.wago.com) – shall apply. In particular, the warranty is void if:

- The product is improperly used.
- The deficiency (hardware and software configurations) is due to special instructions.
- The hardware or software has been modified by the user or a third party.

Individual agreements always have priority.

### Obligations of Installers/Operators

The installers and operators bear responsibility for the safety of an installation or a system assembled with the products. The installer/operator is responsible for proper installation and safety of the system. All laws, standards, guidelines, local regulations and accepted technology standards and practices applicable at the time of installation, and the instructions in the the products' Instructions for Use, must be complied with. In addition, the Installation regulations specified by Approvals must be observed. In the event of non-compliance, the products may not be operated within the scope of the approval.

## 1.2 Typographical Conventions





### Number Notation

100	Decimals: Normal notation
0x64	Hexadecimals: C-notation
'100'	Binary: In single quotation marks
'0110.0100'	Nibbles separated by a period

### Text Formatting

<i>italic</i>	Names of paths or files
<b>bold</b>	Menu items, entry or selection fields, emphasis
Code	Sections of program code
>	Selection of a menu point from a menu
"Value"	Value entries
[F5]	Identification of buttons or keys

### Cross References / Links

	Cross reference / link to a section in a document
	Cross reference / link to a separate document
	Cross reference / link to a website
	Cross reference / link to an email address

### Action Instructions

- ✓ This symbol identifies a precondition.
- 1. Action step
- 2. Action step
  - ⇒ This symbol identifies an intermediate result.
- ⇒ This symbol identifies the result of an action.

### Lists

- Lists, first level
  - Lists, second level

### Notes

#### **DANGER**

##### Type and source of hazard

Possible consequences of hazard that also include death or irreversible injury

- Action step to reduce risk

#### **WARNING**

##### Type and source of hazard

Possible consequences of hazard that also include severe injury

- Action step to reduce risk

#### **CAUTION**

##### Type and source of hazard

Possible consequences of hazard that include at least slight injury

- Action step to reduce risk

#### **NOTICE**

##### Type and source of malfunction (property damage only)

Possible malfunctions that may restrict the product's scope of functions or ergonomics, but do not lead to foreseeable risks to persons

- Action step to reduce risk

#### **Note**

##### Notes and information

Indicates information, clarifications, recommendations, referrals, etc.

## Figures

Figures in this documentation are for better understanding and may differ from the actual product design.

## 1.3 Legal Information

### Intellectual Property

Unless barred by applicable legal provisions, unauthorized copying and distribution of this document, as well as the use and communication of its content are strictly prohibited unless expressly authorized by prior agreement. Third-party products are always mentioned without any reference to patent rights. WAGO Kontakttechnik GmbH & Co. KG, or for third-party products, their manufacturer, retain all rights regarding patent, utility model or design registration.

Third-party trademarks are referred to in the product documentation. The “®” and “™” symbols are omitted hereinafter. The trademarks are listed in the Appendix ( **Protected Rights [▶ 32]**).

### Subject to Change

The instructions, guidelines, standards, etc., in this manual correspond to state of the art at the time the documentation was created and are not subject to updating service. The installer and operator bear sole responsibility to ensure they are complied with in their currently applicable form. WAGO Kontakttechnik GmbH & Co. KG retains the right to carry out technical changes and improvements of the products and the data, specifications and illustrations of this manual. All claims for change or improvement of products that have already been delivered – excepting change or improvement performed under guarantee agreement – are excluded.

### Licenses

The products may contain open-source software. The requisite license information is saved in the products. This information is also available under  [www.wago.com](http://www.wago.com).



# Security

This section contains safety rules that must be followed for hazard-free use of the product.

This section is aimed at the following target groups:

- Planners and installers
- Operators
- Qualified assembly personnel
- Qualified installation personnel (electrical installation, technician network installation etc.)
- Qualified operating personnel
- Qualified service and maintenance personnel

Obey the following safety rules:

## 2.1 General Safety Rules

- This documentation is part of the product. Therefore, retain the documentation during the entire service life of the product. Pass on the documentation to any subsequent user of the product. In addition, ensure that any supplement to this documentation is included, if necessary.
- The product must only be installed and put into operation by qualified electrical specialists per EN 50110-1/-2 and IEC 60364.
- Comply with the laws, standards, guidelines, local regulations and accepted technology standards and practices applicable at the time of installation.

## 2.2 Electrical Safety

- Make sure the product does not carry any voltage before starting work.

### Grounding/Protection/Fuses

- When handling the product, please ensure that environmental factors (personnel, work space and packaging) are properly equalized. Do not touch any conducting parts.

### Cables

- Use shielded cables with copper braiding or tinned copper braiding. This reduces electromagnetic interference and increases signal quality. Measurement errors, data transmission errors and interference due to excessive voltage can be prevented.
- Maintain spacing between control, signal and data lines and the power supply lines. Make sure the pin assignment is correct.
- Maintain spacing between control, signal and data lines and the power supply lines. Make sure the pin assignment is correct.
- Observe permissible temperature range of connecting cables.
- Use appropriate strain relief.

## 2.3 Mechanical Safety

- As the installer of the system, you are responsible for ensuring the necessary touch-proof protection. Follow the installation guidelines for the specific application.

- Before startup, please check the product for any damage that may have occurred during shipping. Do not put the product into operation in the event of mechanical damage.
- Replace any defective or damaged devices.
- Do not open the product housing.
- The product is an open-type device and is designed for installation in an additional enclosure, which supplies the following safety aspects:
  - Restrict access to authorized personnel and may only be opened with tools.
  - Ensure the required pollution degree in the vicinity of the system.
  - Offer adequate protection against direct or indirect contact.
  - Offer adequate protection against UV irradiation.
  - Prevent fire from spreading outside of the enclosure.
  - Guarantee mechanical stability.

## 2.4 Thermal Safety

- The surface of the housing heats up during operation. Under special conditions (e.g., in the event of a fault or increased surrounding air temperature), touching the product may cause burns. Allow the product to cool down before touching it.
- The temperature inside the additional enclosure must not exceed the surrounding air temperature permitted for the mounted product.

## 2.5 Indirect Safety

- Only use a dry or cloth or a clothed dampened with water to clean the product. Do not use cleaning agents, e.g., abrasive cleaners, alcohols or acetone.
- Clean tools and materials are imperative for handling the product.
- Before installation and operation, please read the product documentation thoroughly and carefully. In addition, note the information on the product housing and further information, e.g. at [www.wago.com/](https://www.wago.com/)<item number>.
- The product contains no parts that can be serviced by the user. Always have all service, maintenance and repair work performed by specialists authorized by WAGO.

# Properties

## 3.1 Introduction

With the Modbus RTU Communication Module a Modbus RTU fieldbus environment can be connected to a subordinate product <sup>1)</sup>. The Modbus RTU Communication Module functions as a gateway. Communication between the Modbus RTU Communication Module and Modbus RTU fieldbus environment occurs via RS-485.

The Modbus RTU Communication Module can be used in a fieldbus network or in a peer-to-peer connection. For bus connections, stations that are not powered can also be wired. They do not interrupt the existing bus connection.

<sup>1)</sup> For example, on a WAGO Power Supply Pro 2, firmware version 01.03.07 or higher.

## 3.2 View

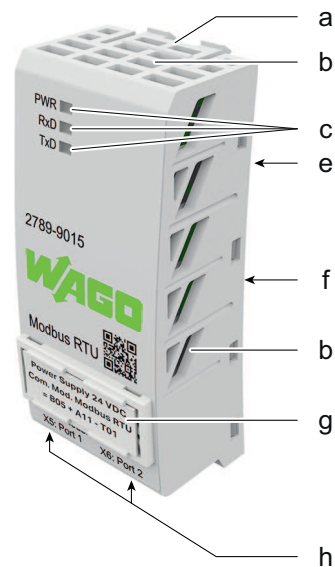

Figure 1: View

Table 3: Legend for "View" Figure

Position	Comment	For Details, See Section
a	Locking tab	–
b	Ventilation openings	–
c	Optical Status Indicator	<a href="#">Indicators [ 13]</a>
d	–	–
e	Communication interface	–
f	Type label	<a href="#">Type label [ 12]</a>
g	Marker carrier	<a href="#">Accessories – Marking [ 32]</a>
h	RJ-45 interfaces (X5)/(X6)	<a href="#">RJ-45 Interfaces [ 13]</a>

### 3.3 Type label

The type label for the product is attached to the back of the housing. It contains the following information:

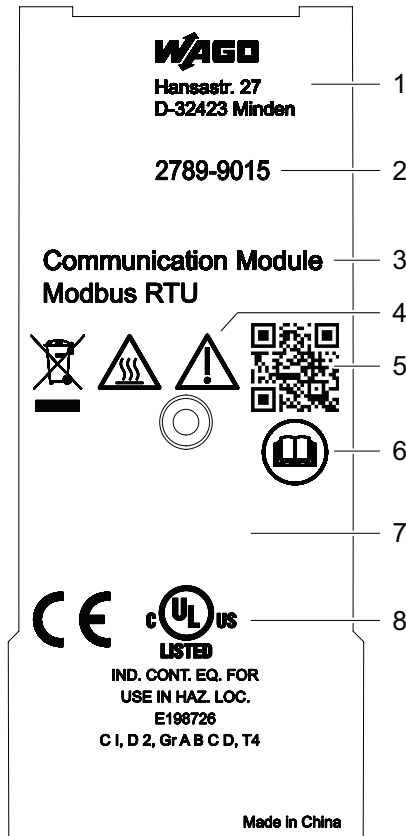

Figure 2: Type label

Table 4: Legend for Figure "Type label"

Position	Comment	For Details, See Section
1	Company logo and address	—
2	Item Number	—
3	Product name	—
4	Warning notice symbols	<a href="#">Safety [ 9 ]</a>
5	QR link with link to website	—
6	Reference to product documentation	—
7	Product-specific information	<a href="#">Product-specific information [ 12 ]</a>
8	Box for approvals	Approvals

### 3.4 Product-specific information

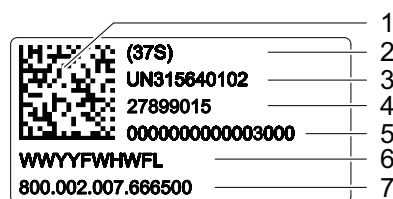

Figure 3: Product-specific information

Table 5: Legend for Figure "Product-Specific Information"

Position	Comment	Details
1	2D data matrix code	Contains the information from positions 2 ... 5
2	Key number	Fixed information (37S)
3	ID number per D-U-N-S®	Fixed information (WAGO Minden)
4	WAGO item number or internal SAP number	Product-specific
5	Consecutive number	Product-specific
6	Production date and revision	<ul style="list-style-type: none"> <li>Production date</li> <li>Revision index (xx yy zz)</li> </ul>
7	Internal manufacturer product number	Product-specific

Software Index	Hardware Index	Boot Loader Index
xx	yy	zz

### 3.5 Connections

#### 3.5.1 RJ-45 Interfaces

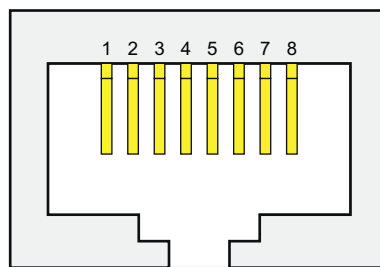

Figure 4: RJ-45 Interfaces X5/X6

Table 7: Legend for Figure "RJ-45 Interfaces X5/X6"

Pin	Description
4	Contact "A" (D+/D1)
5	Contact "B" (D-/D0)
8	Contact "GND"

### 3.6 Indicators

The product has an optical status indicator. This indicator consists of three LEDs.

- PWR
- RxD
- TxD

Figure 5: Optical Status Indicator

Table 8: Operating Status Indication

Indicator	Operating Mode		
	Ready for operation	Communication active Status: Query received	Communication active Status: Response sent
PWR <span style="display: inline-block; width: 10px; height: 10px; background-color: green; vertical-align: middle;"></span>	Steady	Steady	Steady
RxD <span style="display: inline-block; width: 10px; height: 10px; background-color: yellow; vertical-align: middle;"></span>	Off	Flashes once (per telegram)	Off

Table 8: Operating Status Indication

Indicator		Operating Mode		
		Ready for operation	Communication active Status: Query received	Communication active Status: Response sent
TxD	■	Off	Off	Flashes once (per telegram)

### 3.7 Technical data

#### 3.7.1 Product

Table 9: Technical Data – Product

Property	Value
Width	35 mm
Height	80 mm
Depth	22 mm
Weight	35 g
Degree of protection	IP20

#### 3.7.2 Power Loss

Table 10: Technical Data – Power Loss

Property	Value
Power loss (max.)	0.22 W

#### 3.7.3 Communication

Table 11: Technical Data – Communication

Property	Value
Communication protocol	Modbus RTU
Interface	RJ-45 interface
Physical interface	RS-485 interface
Cable length	≤ 1200 m (depending on baud rate)
Transmission medium	Twisted pair, shielded
Type of conductors used	≥ +75°C / +167°F (ambient air temperature: ≤ +60°C / 140°F) ≥ +90°C / 194°F (ambient air temperature: > +60°C / 140°F)
Baud rate	4800 ... 115200 Baud
Maximum voltage (RJ-45 interface)	-7 ... +12 V (SELV)
Maximum number of bus subscribers	247

#### 3.7.4 Environmental Conditions

Table 12: Technical Data – Environmental Conditions

Property	Value
Test voltage (communication interface / RJ-45 interface)	1 kVAC, 50 Hz, 1 min.
Type of insulation	Functional insulation
Surrounding air temperature, operation	-40 ... +70 °C
Surrounding air temperature, storage	-40 ... +85 °C
Relative humidity	5 ... 95 % (no condensation)
Elevation above sea level, max.	5000 m

Table 12: Technical Data – Environmental Conditions

Property	Value
Pollution degree according to IEC/EN 60664-1	2
Protection class	III
Degree of protection <sup>1)</sup>	IP20



<sup>1)</sup> The subordinate WAGO Power Supply Pro 2

## 3.8 Guidelines, approvals and standards

### 3.8.1 Guidelines

An EU “Declaration of Conformity” and CE marking exist for the product:



Table 13: Guidelines

Logo	Explanation	Verification
	CE marking	 <a href="#">WAGO website</a>

### 3.8.2 Approvals

The following approvals have been granted for the product:

Table 14: Approvals

Logo	Certification Body	Standard
	Underwriters Laboratories	UL 61010-1, UL 61010-2-201
	Hazardous location	UL 121201, Class I, Division 2, Groups A B C D, T4

#### Note

#### More information on approvals

You can find detailed information on the approvals online at:  [www.wago.com/](http://www.wago.com/)<item number>

### 3.8.3 Standards

Table 15: Mechanical and Climatic Environmental Conditions

Standard	Test Value
<b>Mechanical Environmental Conditions</b>	
EN 60068-2-6	f = 5 ... 150 Hz: 1g, 3.5 m
IEC 60068-2-27 shock	15g, 11 ms, 6 shocks per axis and direction, half-sine
EN 61131-2, sec. 4.3	Freefall ≤ 300 mm (packaged in the product packaging)
<b>Climatic Environmental Conditions</b>	
EN 60870-2-2	3K3 (except for low air pressure)

Table 16: EMV – Immunity to Interference

Standard	Title
EN 61000-6-2	Part 6-2: Generic standards – Immunity for industrial environments

Table 16: EMV – Immunity to Interference

Standard	Title
EN 61000-4-2	Part 4-2: Testing and measurement techniques – Electrostatic discharge immunity test
EN 61000-4-3	Part 4-3: Testing and measurement techniques – Radiated, radio-frequency, electromagnetic field immunity test
EN 61000-4-4	Part 4-4: Testing and measurement techniques – Electrical fast transient/burst immunity test
EN 61000-4-5	Part 4-5: Testing and measurement techniques – Surge immunity test
EN 61000-4-6	Part 4-6: Testing and measurement techniques – Immunity to conducted disturbances, induced by radio-frequency fields

Table 17: EMC – Emission of Interference

Standard	Title
EN 61000-6-3	Part 6-3: Generic standards – Emission standard for residential, commercial and light-industrial environments

### 3.8.4 Special Requirements

Observe the following:

- Perform installation according to the local conditions, applicable regulations (e.g., VDE 0100), national accident prevention specifications (e.g., UVV-VBG4 or DGUV Regulation 2) and accepted technical regulations.
- This product is intended for installation in electrical systems or machines and fulfills the requirements of the Low Voltage Directive.

When installing in machines, the following also applies:

- When installing in machines, normal operation must not commence until it is determined that the machine complies with the requirements of the Machinery Directive, EN 60204.
- Commencement of normal operation is allowed only on the condition of compliance with the EMC Directive.
- The manufacturer of the system or machine is responsible for ensuring compliance with the limit values required by EMC legislation.



# Fieldbus Description

## 4.1 Technology

### 4.1.1 Topology

The RS-485 standard defines a fieldbus cable as a “cable with a beginning and an end, each terminated with a terminating resistor  $R_T$ ”. The resistance value of this terminating resistor should correspond to the line impedance. Typical values are 100 ... 150  $\Omega$ . The slaves are connected to the fieldbus with a short cable or the fieldbus cable is connected directly to the slave and from there to the next slave. Radial wiring is not possible. The number of possible slaves on a fieldbus depends on the so-called “unit load” of the connected slaves.

### 4.1.2 Addressing

The slaves have an adjustable address. The address range is between 1 and 247. The address “0” is reserved for broadcasts (messages to all slaves), e.g., “Setting the time” or “Setting the baud rate”. The addresses from 248 to 255 are reserved. The master does not have its own address.

#### Note

##### **Configure fieldbus subscribers in the same mode!**

All connected fieldbus subscribers (slaves and masters) in the network must be configured in the same mode!

### 4.1.3 Manual Addressing of a Subordinate WAGO Power Supply Pro 2

The easiest way to set the address of the subordinate WAGO Power Supply Pro 2 is using the WAGO Interface Configuration software. More information is available in the respective  **Product Manual** of the 2787 Series.

If no WAGO Interface Configuration software or no WAGO USB Communication Cable is available, the address can also be set manually.

The following requirements must be met in order to assign a WAGO Power Supply Pro 2 address manually:

- The firmware version of the WAGO Power Supply Pro 2 must be at least 01.03.07 or higher.
- The WAGO Power Supply Pro 2 is connected to the corresponding supply voltage.
- The WAGO Power Supply Pro 2 ready for operation.

#### **Signaling**

The set address is indicated by the LEDs of the subordinate WAGO Power Supply Pro 2. Each LED can signal two different values.

The following applies to allocating addresses:

- **Address value  $\leq 15$ :** The **Value (Low)** applies.

- **Address value > 15:** The LED display changes every second between the **Value (Low)** and the **Value (High)**. The higher value is indicated by the red LED.

Table 18: Signaling: Value (Low)











LED	Address Value
	switched off
	8
	4
	2
	1

Table 19: Signaling: Value (High)

LED	Address Value
	switched on
	128
	64
	32
	16

### Manual Address Assignment

Proceed as follows to set the address manually:

1. Press the **[+]** and **[-]** keys simultaneously for six seconds until the red LED flashes twice in a row.
  - ⇒ The address can now be set manually.
2. Set the required address in binary format using the **[+]** and **[-]** keys:
  - By pressing the **[+]** key you increase the address value incrementally, by pressing the **[-]** key you decrease the address value incrementally.
  - ⇒ The LEDs signal the set address.
3. Press the **[+]** and **[-]** keys buttons simultaneously for six seconds.
  - ⇒ The set address is saved.

### Example: Entering the address 42

The following is an example of how the address 42 is assigned to the WAGO Power Supply Pro 2:

1. Carry out Step 1 from the Section [Manual Address Assignment \[ > 18\]](#).
2. Press the **[+]** key until the flashing sequence shown in the following tables occurs.
3. Carry out Step 3 from the Section [Manual Address Assignment \[ > 18\]](#).

Table 20: Example: Entering the address 42; Value (Low)











LED	Address Value
	switched off
	8
	4
	2
	1

Table 21: Example: Entering the address 42; Value (High)

LED	Address Value
	switched on
	128
	64
	32
	16

The term “flashing sequence” means that the values are output one after the other via the LEDs every second. The **Value (Low)** is output first; then the **Value (High)**.

The address 42 results from adding the green LEDs:  $2+8+32=42$ .

#### 4.1.4 Cables

##### Cable Type

Use shielded conductors only. The shielding must lie on both sides.

##### Cable Length

The total length of the bus cable must not exceed 1200 m. This value depends on the baud rate. The length is measured from one end to the other. Any drop cables that may be present must be added to the total line length.

##### Line Termination

To guarantee faultless data transfer on all cables, the cables should be self-contained. Terminating resistors, among other things, are suitable for this.

A Modbus® Master usually has a switchable termination resistor.

A Modbus® Slave normally does not have a built-in termination resistor. If possible, use an external termination resistor (see Section [🔗 Accessories \[▶ 32\]](#)).

### Note

#### Positioning the Termination Resistor

Always position a termination resistor at the beginning or end of the bus cable!

Use a maximum of 2 termination resistors in networks without repeaters!

Note the following points when positioning termination resistors:

- Where are the nodes spatially positioned?
- Where are the repeaters spatially positioned?
- Where is the PC positioned?
- Where is the beginning of the cable, where is the end of the cable?
- What are the total cable lengths?

#### 4.1.5 Function Codes

The Modbus® Specification defines various function codes (FC). The following three function codes are supported by all products in the WAGO Power Supply Pro 2 Series:

Table 22: Function Codes

FC	Designation	Description
FC3	Read Holding Register	Reads the parameters from the product
FC4	Read Input Register	Reads the measured values from the product
FC16	Write Multiple Register	Writes the parameters to the product

#### 4.1.6 Exception Codes

##### Exception Codes acc. Modbus® Specification (“Frame Exceptions”)

Table 23: Exception Codes acc. Modbus® Specification (“Frame Exceptions”)

Code	Designation	Explanation
0x01	Illegal Function	Function not supported
0x02	Illegal Data Address	Parameter not available at this address
0x03	Illegal Data Value	Parameter length invalid; structure error, CRC error

##### User-defined Exception Codes (“Parameter Exception”)

Table 24: User-defined Exception Codes (“Parameter Exception”)

Code	Designation	Description
0x9B	PAR_READONLY	Write to parameter “read only”
0xA8	VAL_OUTOF_RNG	Value out of range
0xAD	FUNC_NOTAVAIL	Write invalid value to command parameter
0xAE	FUNC_NOTAVAIL_TEMP	Command not possible due to the current command status (e.g., during block parameterization that is not closed; other commands are rejected)
0xB8	PAR_SETINVALID	Parameter single access: Parameter value inconsistent with other parameter values
0xB9	PAR_SETINCONSIST	Block parameterization: Parameter set inconsistent
0xD0	PASS_PROTECTION_ACTIVE	No parameter access, password protection enabled

## 4.2 Module Parameters

### 4.2.1 General Module Parameters

The Modbus RTU Communication Module uses the following general parameters of a subordinate WAGO Power Supply Pro 2. These parameters can be read and written using the function codes FC3 and FC16.

#### Device Identification

Table 25: General module parameters: device identification

Address		Access	Data Type	Description
Dec.	Hex.			
2	0002	read only	UINT32	Item Number
4	0004	read only	UINT32	Item number extension
8	0008	read/write	UINT32	Consecutive number (“High Word”)
10	000A	read/write	UINT32	Consecutive number (“Low Word”)
12	000C	read only	UINT16	Firmware version (major)
13	000D	read only	UINT16	Firmware version (minor)

Table 25: General module parameters: device identification

Address		Access	Data Type	Description
Dec.	Hex.			
14	000E	read only	UINT16	Firmware version (bug fix)
15	000F	read/write	UINT16	Hardware version
20	0014	read only	CHAR32	Item description
36	0024	read/write	CHAR32	Device name
52	0034	read/write	CHAR32	Customer information (1)
68	0044	read/write	CHAR32	Customer information (2)
84	0054	write only	CHAR8	Password
92	005C	read/write	UINT16	Password Level

### “Password Level” Parameter

The behavior of the product with regard to password protection is controlled by the “Password level” parameter. There are four password levels for this:

- **Password level 0 (value 0):**  
No parameters are password protected.
- **Password level 1 (value 1):**  
All parameters are read-only.
- **Password level 2 (value 2):**  
All parameters are write- and read-protected.
- **Password level 3 (value 3):**  
All parameters are write- and read-protected. In addition, process data outputs (e.g., “Switch product on and off” or “Activate digital output”) are write-protected.

Table 26: “Password Level” Parameter

Password Level	Parameter: Write protection	Parameter: Read protection	Process data: Write protection	Process data: Read protection
0	No	No	No	No
1	Yes	No	No	No
2	Yes	Yes	No	No
3	Yes	Yes	Yes	No

### Modbus®

Table 27: General module parameters: Modbus®

Address		Access	Data Type	Description
Dec.	Hex.			
122	007A	read/write	UINT16	Device address
124	007C	read/write	UINT32	Baud rate This parameter can be used to set the baud rate. The following options are available: <ul style="list-style-type: none"> <li>• 4800 baud</li> <li>• 9600 baud</li> <li>• 19200 baud</li> <li>• 38400 baud</li> <li>• 57600 baud</li> <li>• 115200 baud</li> </ul>
126	007E	read/write	UINT16	Data Bits

Table 27: General module parameters: Modbus®

Address		Access	Data Type	Description	
Dec.	Hex.				
127	007F	read/write	UINT16	Stopbits The following options are available:	
				<b>Value</b>	<b>Stopbit</b>
				0	1
				1	0.5
				2	2.5
3	3.5				
128	0080	read/write	UINT16	Parity The following options are available:	
129	0081	read/write	UINT16	Response delay	
130	0082	read/write	UINT16	Data format The following options are available: <ul style="list-style-type: none"> <li>• 0: BigEndian (B0, B1, B2, B3)</li> <li>• 1: MiddleEndian (B2, B3, B0, B1)</li> <li>• 2: LittleEndian (B3, B2, B1, B0)</li> </ul>	

#### 4.2.2 Specific Module Parameters of the WAGO Power Supply Pro 2

The Modbus RTU Communication Module uses the following general parameters of a subordinate WAGO Power Supply Pro 2. These parameters can be read and written using the function codes FC3 and FC16.

#### Output

Table 28: Specific module parameters of the Power Supply Pro 2: Output

Address		Access	Data Type	Description	
Dec.	Hex.				
136	0088	read/write	UINT16	Output voltage (unit: mV)	
137	0089	read/write	UINT16	Warning threshold (unit: mA)	
138	008A	read/write	UINT16	Bit 0	Output On
				Bit 1	“Active droop” parallel mode
				Bit 2	Overload limit active
				Bit 3	Enable switching the DC output on and off via cyclic process data
				Bit 4	reserved
				Bit 5	reserved
				Bit 6 <sup>1)</sup>	Constant current
				Bit 7 <sup>1)</sup>	Constant current (latching mode)
				Bit 8 <sup>1)</sup>	Hiccup mode
				Bit 9 <sup>1)</sup>	Electronic circuit breaker
				Bit 10	reserved
				Bit 11	reserved
				Bit 12	Latching after thermal overload
				Bit 13	Power Boost
				Bit 14	Top Boost
Bit 15	reserved				
139	008B	read/write	UINT16	Switch-on delay (unit: ms)	

<sup>1)</sup> These bits are mutually interlocked.

## Electronic Circuit Breaker

Table 29: Specific module parameters of the Power Supply Pro 2: Electronic circuit breaker

Address		Access	Data Type	Description
Dec.	Hex.			
148	0094	read/write	UINT16	Trip current (unit: mA)
149	0095	read/write	UINT16	Trip delay (unit: ms)

## Digital input

Table 30: Specific module parameters of the Power Supply Pro 2: Digital input

Address		Access	Data Type	Description	
Dec.	Hex.			Bit	Description
168	00A8	read/write	UINT16	Bit 0	Power supply standby on/off
				Bit 1	reserved
				Bit 2	reserved
				Bit 3	reserved
				Bit 4	reserved
				Bit 5	reserved
				Bit 6	reserved
				Bit 7	reserved
				Bit 8	reserved
				Bit 9	reserved
				Bit 10 <sup>1)</sup>	Inversion
				Bit 11 <sup>1)</sup>	Function triggered by low-high transition
				Bit 12 <sup>1)</sup>	Function triggered by high-low transition
				Bit 13	reserved
				Bit 14	reserved
				Bit 15	reserved

<sup>1)</sup> These bits are mutually interlocked.

## Digital Output

Table 31: Specific module parameters of the Power Supply Pro 2: Digital output

Address		Access	Data Type	Description	
Dec.	Hex.				
176	00B0	read/write	UINT16	Bit 0	DC O.K.
				Bit 1	Load current warning level exceeded
				Bit 2	Electronic circuit breaker tripped
				Bit 3	Power supply switched off (latched)
				Bit 4	Digital output via process data/communication
				Bit 5	Digital output on
				Bit 6	reserved
				Bit 7	reserved
				Bit 8	reserved
				Bit 9	reserved
				Bit 10	Inversion
				Bit 11	reserved
				Bit 12	reserved
				Bit 13	reserved
				Bit 14	reserved
				Bit 15	reserved

## System

Table 32: Specific module parameters of the Power Supply Pro 2: System

Address		Access	Data Type	Description	
Dec.	Hex.				
189	00BD	read/write	UINT16	Bit 0 <sup>1)</sup>	Restore previous status
				Bit 1 <sup>1)</sup>	DC output remains switched off
				Bit 2 <sup>1)</sup>	DC output to be switched on
				Bit 3	Switch-on delay active
				Bit 4	reserved
				Bit 5	reserved
				Bit 6	Activate key lock
				Bit 7	Disable reset to factory settings
				Bit 8	reserved
				Bit 9	reserved
				Bit 10	reserved
				Bit 11	reserved
				Bit 12	reserved
				Bit 13	reserved
				Bit 14	reserved
				Bit 15	reserved

<sup>1)</sup> These bits are mutually interlocked.



## 4.3 Messages and Events

### 4.3.1 Events and Measured Values for WAGO Power Supply Pro 2

The Modbus RTU Communication Module outputs the WAGO-specific events and measured values listed below. These events and measured values can be read using the function codes FC3 and FC4.

#### Process Output Data

Table 33: Measured values for WAGO Power Supply Pro 2: Process input data

Address				Data Type	Description
FC3		FC4			
Dec.	Hex.	Dec.	Hex.		
1280	0x0500	0	0x0000	UINT16	Voltage (unit: V)
1281	0x0501	1	0x0001	UINT16	Current (unit: A)

#### Status Messages

Table 34: Measured values for WAGO Power Supply Pro 2: Status messages

Address				Data Type	Description	
FC3		FC4				
Dec.	Hex.	Dec.	Hex.			
1282	0x0502	2	0x0002	UINT16	Bit 0	Status DC O.K.
					Bit 1	Overheating
					Bit 2	No output voltage
					Bit 3	Output short circuit
					Bit 4	Status of digital input

#### Warnings

Table 35: Measured values for WAGO Power Supply Pro 2: Warnings

Address				Data Type	Description	
FC3		FC4				
Dec.	Hex.	Dec.	Hex.			
1283	0x0503	3	0x0003	UINT16	Bit 0	Output under-voltage
					Bit 1	Output over-voltage
					Bit 2	Overload
					Bit 3	Adjustable output current limit exceeded
					Bit 4	Configurable operating hours reached
					Bit 5	Top Boost supplied
					Bit 6	Power Boost supplied
					Bit 7	High device temperature
					Bit 8	–

**Error**

Table 36: Measured values for WAGO Power Supply Pro 2: Errors

Address				Data Type	Description	
FC3		FC4				
Dec.	Hex.	Dec.	Hex.			
1284	0x0504	4	0x0004	UINT16	Bit 0	Overheating, device switched off
					Bit 1	No output voltage
					Bit 2	Output short circuit
					Bit 3	Electronic circuit breaker tripped

**Power/Energy**

Table 37: Measured values for WAGO Power Supply Pro 2: Power/energy

Address				Data Type	Description
FC3		FC4			
Dec.	Hex.	Dec.	Hex.		
1286	0x0506	6	0x0006	UINT32	Output power (unit: W)
1288	0x0508	8	0x0008	UINT32	Output level for the previous second (unit: Ws)
1290	0x050A	10	0x000A	UINT32	Output level for the previous minute (unit: Ws)
1292	0x050C	12	0x000C	UINT32	Output level for the previous hour (unit: Wh)

# Transport and Storage

The original packaging offers optimal protection during transport and storage.

- Store the product in suitable packaging, preferably the original packaging.
- Only transport the product in suitable containers/packaging.
- Make sure the product contacts are not contaminated or damaged during packing or unpacking.
- Observe the specified ambient climatic conditions for transport and storage ().

# Installation and Removal

## ! NOTICE

### Avoid electrostatic discharge!

The products are equipped with electronic components that may be destroyed by electrostatic discharge when touched. Please observe the safety precautions against electrostatic discharge per DIN EN 61340-5-1/-3. When handling the products, please ensure that environmental elements (personnel, work space and packaging) are properly grounded.

## ! NOTICE

### Do not cover the ventilation openings!

To ensure adequate air circulation, the ventilation openings must be kept clear. Maintain a distance of at least 50 mm from the ventilation openings to adjacent surfaces.

The letters shown in parentheses refer to positions in the “View” figure in section [View \[▶ 11\]](#).

### Mounting Positions

Nominal mounting position (see also figure under [View \[▶ 11\]](#)): Front side facing forwards, marking legible, and bottom ventilation openings facing upwards and downwards.

### Installation

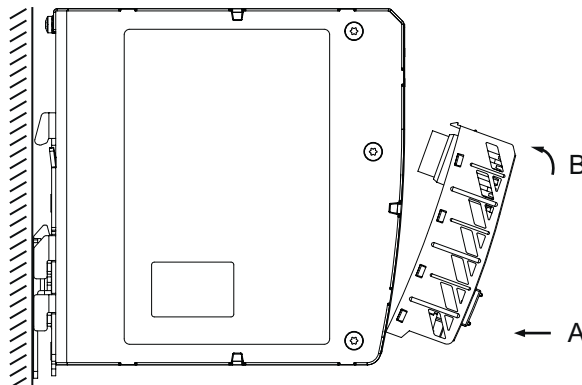

Figure 6: Installation

Install the product by snapping it onto the WAGO Power Supply Pro 2 (see Figure “Installation”):

1. Remove the cap of the communication interface on the WAGO Power Supply Pro 2.
2. Keep the cap in a safe place so that you can cover the communication interface again when this interface is not required.
3. Remove the mounted marker carrier on the WAGO Power Supply Pro 2.
4. Insert the product with the lower latches into the lower mounting slots of the WAGO Power Supply Pro 2 [A].

5. Slide the product toward the communication interface [B] until the top latches catch in the top mounting slots.
6. Check that the product is properly locked position.

### Removal

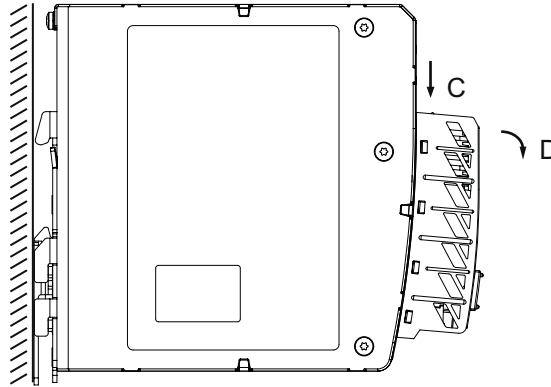

Figure 7: Removal

1. Press the top locking tab (a) of the product [C].
2. Pivot the product to remove it from the WAGO Power Supply Pro 2 [D].

# Connection

## 7.1 Connect

### **WARNING**

#### **Do not insert a tool into the ventilation slots!**

Components inside the device may be damaged if the blade of an operating tool enters the ventilation slots. This may lead to serious damage with a risk of injury caused by malfunction, overheating or electric shock!



- When using a screwdriver or an operating tool, ensure correct positioning between the locking latch and the female connector!

Wire the product using an operating tool or a suitable screwdriver.

# Decommissioning

## 8.1 Disposal and Recycling

Table 38: WEEE Mark

Logo	Description
 	<p>Electrical and electronic equipment may not be disposed of with household waste. This also applies to products without this mark.</p>

Electrical and electronic equipment contain materials and substances that can be harmful to the environment and health. Electrical and electronic equipment must be disposed of properly after use. Environmentally friendly disposal benefits health, protects the environment from harmful substances in electrical and electronic equipment and enables sustainable and efficient use of resources.

- Observe national and local regulations for the disposal of batteries, packaging and electrical and electronic equipment.
- Clear any data stored on electrical and electronic equipment.
- Remove any batteries or memory cards installed in electrical and electronic equipment.
- Dispose of all types of packaging to ensure a high level of recovery, reuse and recycling.
- Have electrical and electronic equipment sent to a local collection point.
- The guidelines 2006/66/EG, PPWD 2018/852/EU and WEEE 2012/19/EU apply throughout Europe. National directives and laws may vary.

# Appendix

## 9.1 Accessories

The following accessories are available for the product:

### Accessories – Marking

Table 39: Accessories – Marking

Description	Designation	Item Number
Marker carrier	-	2787-1233
Marking System	-	2009-0110
WMB Multi Marking System	-	2009-0115
	-	2009-0115/0000-0002

### Accessories – Other

Table 40: Accessories – Other

Description	Item Number
RJ-45 Termination Resistor, 120 Ω	2789-9915

## 9.2 Protected Rights

- Adobe® and Acrobat® are registered trademarks of Adobe Systems Inc.
- Android™ is a trademark of Google LLC.
- Apple, the Apple logo, iPhone, iPad and iPod touch are registered trademarks of Apple Inc. registered in the USA and other countries. “App Store” is a service mark of Apple Inc.
- AS-Interface® is a registered trademark of the AS-International Association.
- BACnet® is a registered trademark of the American Society of Heating, Refrigerating and Air Conditioning Engineers, Inc. (ASHRAE).
- Bluetooth® is a registered trademark of Bluetooth SIG, Inc.
- CiA® and CANopen® are registered trademarks of CAN in AUTOMATION – International Users and Manufacturers Group e.V.
- DALI is a registered trademark of the Digital Illumination Interface Alliance (DiiA).
- EtherCAT® is a registered trademark and patented technology licensed by Beckhoff Automation GmbH, Germany.
- ETHERNET/IP™ is a registered trademark of the Open DeviceNet Vendor Association, Inc (ODVA).
- EnOcean® is a registered trademark of EnOcean GmbH.
- Google Play™ is a registered trademark of Google Inc.
- IO-Link is a registered trademark of PROFIBUS Nutzerorganisation e.V.
- KNX® is a registered trademark of the KNX Association cvba.
- Linux® is a registered trademark of Linus Torvalds.
- LON® is a registered trademark of the Echelon Corporation.
- Modbus® is a registered trademark of Schneider Electric, licensed for Modbus Organization, Inc.
- PROFIBUS® is a registered trademark of Siemens AG.
- PROFINET® is a registered trademark of Siemens AG.
- QR Code is a registered trademark of DENSO WAVE INCORPORATED.



- Subversion® is a trademark of the Apache Software Foundation.
- Windows® is a registered trademark of Microsoft Corporation.

# List of Tables

Table 1	Complete instructions for use .....	5
Table 2	Additional documentation.....	5
Table 3	Legend for “View” Figure .....	11
Table 4	Legend for Figure “Type label”.....	12
Table 5	Legend for Figure “Product-Specific Information” .....	13
Table 6	Revision index structure.....	13
Table 7	Legend for Figure “RJ-45 Interfaces X5/X6” .....	13
Table 8	Operating Status Indication.....	13
Table 9	Technical Data – Product.....	14
Table 10	Technical Data – Power Loss .....	14
Table 11	Technical Data – Communication .....	14
Table 12	Technical Data – Environmental Conditions .....	14
Table 13	Guidelines .....	15
Table 14	Approvals .....	15
Table 15	Mechanical and Climatic Environmental Conditions .....	15
Table 16	EMV – Immunity to Interference .....	15
Table 17	EMC – Emission of Interference .....	16
Table 18	Signaling: Value (Low).....	18
Table 19	Signaling: Value (High) .....	18
Table 20	Example: Entering the address 42; Value (Low).....	18
Table 21	Example: Entering the address 42; Value (High).....	19
Table 22	Function Codes.....	20
Table 23	Exception Codes acc. Modbus® Specification (“Frame Exceptions”).....	20
Table 24	User-defined Exception Codes (“Parameter Exception”).....	20
Table 25	General module parameters: device identification.....	20
Table 26	“Password Level” Parameter .....	21
Table 27	General module parameters: Modbus®.....	21
Table 28	Specific module parameters of the Power Supply Pro 2: Output.....	22
Table 29	Specific module parameters of the Power Supply Pro 2: Electronic circuit breaker .....	23
Table 30	Specific module parameters of the Power Supply Pro 2: Digital input.....	23
Table 31	Specific module parameters of the Power Supply Pro 2: Digital output.....	24
Table 32	Specific module parameters of the Power Supply Pro 2: System.....	24
Table 33	Measured values for WAGO Power Supply Pro 2: Process input data .....	25
Table 34	Measured values for WAGO Power Supply Pro 2: Status messages.....	25
Table 35	Measured values for WAGO Power Supply Pro 2: Warnings .....	25
Table 36	Measured values for WAGO Power Supply Pro 2: Errors .....	26

---

Table 37	Measured values for WAGO Power Supply Pro 2: Power/energy .....	26
Table 38	WEEE Mark .....	31
Table 39	Accessories – Marking .....	32
Table 40	Accessories – Other.....	32

# List of Figures

Figure 1	View .....	11
Figure 2	Type label.....	12
Figure 3	Product-specific information.....	12
Figure 4	RJ-45 Interfaces X5/X6.....	13
Figure 5	Optical Status Indicator.....	13
Figure 6	Installation.....	28
Figure 7	Removal.....	29



**WAGO Kontakttechnik GmbH & Co. KG**

Postfach 2880 · D - 32385 Minden  
Hansastraße 27 · D - 32423 Minden

✉ [info@wago.com](mailto:info@wago.com)  
🌐 [www.wago.com](http://www.wago.com)

Headquarters	+49 571/887 – 0
Sales	+49 (0) 571/887 – 44 222
Order Service	+49 (0) 571/887 – 44 333
Fax	+49 571/887 – 844169

WAGO is a registered trademark of WAGO Verwaltungsgesellschaft mbH.

Copyright – WAGO Kontakttechnik GmbH & Co. KG – All rights reserved. The content and structure of the WAGO websites, catalogs, videos and other WAGO media are subject to copyright. Distribution or modification of the contents of these pages and videos is prohibited. Furthermore, the content may neither be copied nor made available to third parties for commercial purposes. Also subject to copyright are the images and videos that were made available to WAGO Kontakttechnik GmbH & Co. KG by third parties.