

TK060.505 Rotatable Module

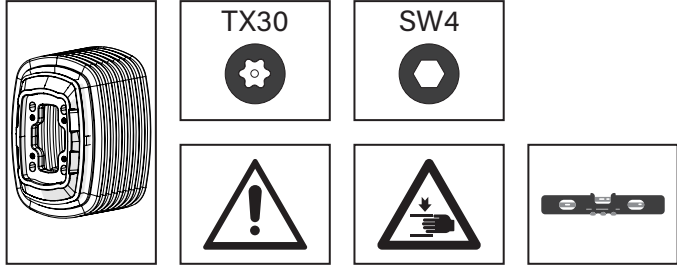

The product can rotate to $\pm 90^\circ$ angles as follows when first out of the box
 Ürün kutudan ilk çıktığında aşağıdaki gibi $\pm 90^\circ$ açılara dönebilir

1

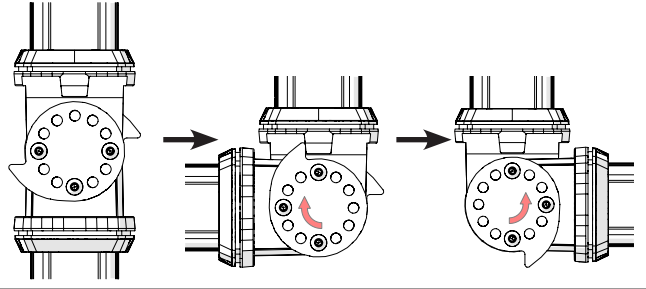

Mounting View Montaj Görünümü

This part will be positioned as in the figure
 Bu kısım şekildeki gibi konumlanacaktır

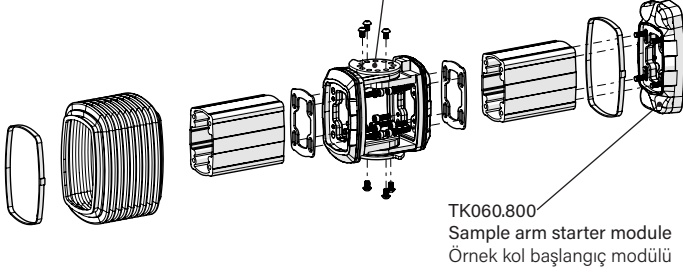

Angle can be set with M8x12 bolts (30° between two holes)
 M8x12 civatalar ile açı ayarı yapılabilir (iki delik arası 30°)

2

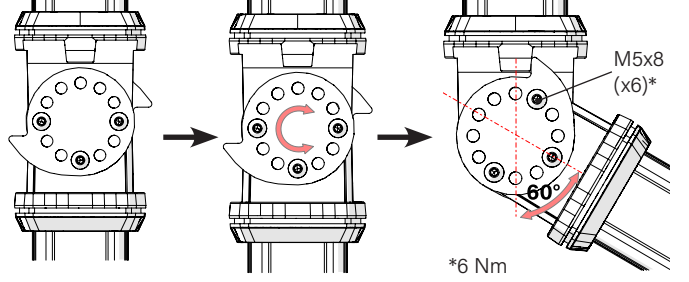

Box Contents Kutu İçeriği

8x M6x30

4x M6x20

8x J6.4 (M6)

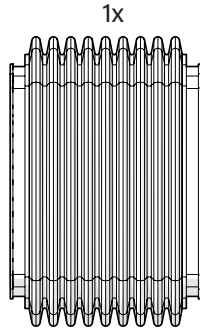
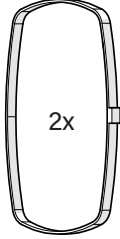
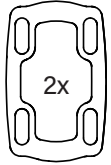

3

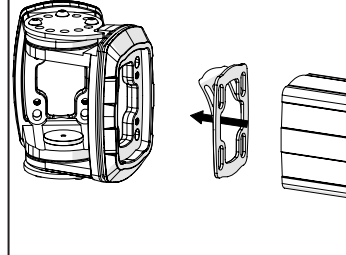

4

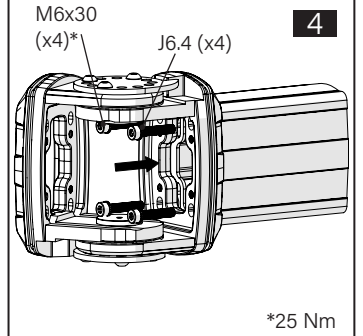

5

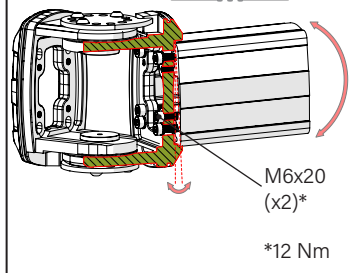

6

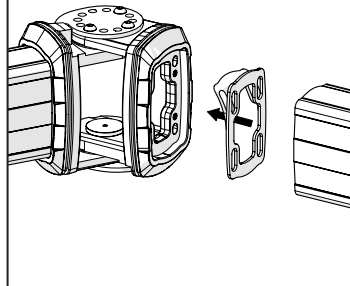

7

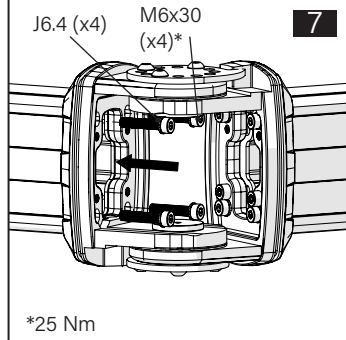

8

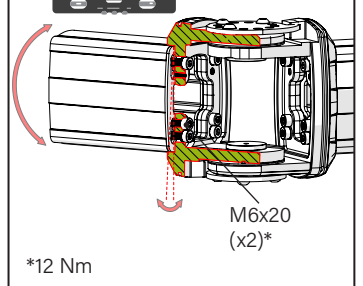

Scan for the installation manual
 Kurulum kılavuzu için tarayın

9

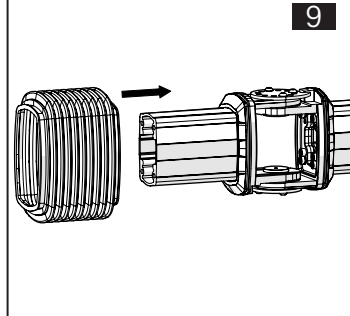

10

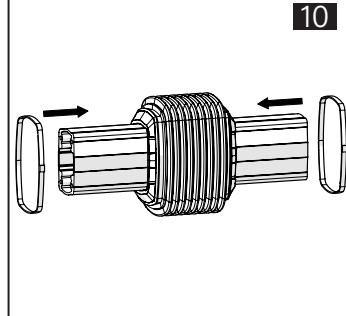

11

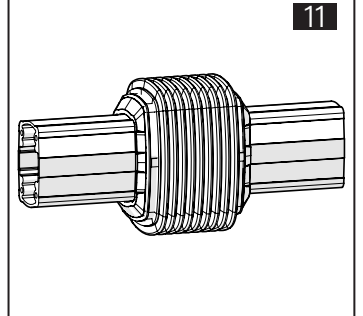

ENCL.ACC.
E510113