



SSP

Safety System Products

HOLDX RL1-P8-W-B

Magnetic guard lock individual, reteachable coding, Pigtail M12 8-pin, 1200 N locking force

Your advantages

- PLe according to EN 13849-1
- High Coded according to EN 14119
- From little windows up to big safety doors
- Shortest commisioning time
- Pigtail connection reduces cabling effort
- Less down- and setup time, due to maintenance Monitoring
- High tolerance for door offsets
-

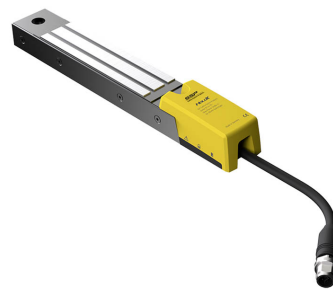

To the downloads ►

we simplify safety



Safety System Products

HOLDX RL1-P8-W-B

Ideal for large doors. Thanks to the locking force of **1200 N**, the **HOLDX RL** prevents doors from being torn open. With a slim width of only 35 mm, the guard locking is ideal for space-saving mounting on aluminum profile systems. In addition to the guard locking force of the electromagnet, the flexibly mounted armature plate also has a 50 N permanent magnet that prevents a door from immediately bursting open. The integrated RFID security sensor meets the highest **performance level PLe according to EN ISO 13849-1:2016**. An integrated **Bluetooth interface** and the extended LED diagnostics enable smart operation as well as fast diagnostics.

HOLDX R User Tutorials Our HOLDX R User Tutorials are now available as a playlist on YouTube! Our product manager Rico Czernig explains topics like the subsequent magnet calibration or diagnostic data. Have a look at the playlist for HOLDX RL and RS, as well as for our HOLDX Manager!

General data

| | |
|------------------|----------------|
| Type designation | RL1-P8-W-B |
| Item number | SP-X-71-001-07 |
| Coding levels | Individually |

Safety relevant data

| | |
|--|-------------------------|
| Category (EN ISO 13849-1: 2015) | Cat.4 |
| SIL (IEC 61508: 2010) | SIL3 |
| - Hardware fault tolerance | HFT1 |
| - PFHd | 2,24 x 10 ⁻⁹ |
| Service life (EN IEC 62061) | 20 Years |
| Switching current per safety output max. | 100 mA (DC-12/DC-13) |

Safety data

| | |
|--|-----|
| Performance Level (EN ISO 13849-1: 2015) | PLe |
|--|-----|



Safety System Products

HOLDX RL1-P8-W-B

Environmental conditions

| | |
|----------------------------|-----------------|
| Max. storage temperature | -20 °C...+70 °C |
| Max. operating temperature | -20 °C...+55 °C |
| Protection class | IP67 |
| ΔT max | 0,5 °C/ min |

Electrical data

| | |
|--|--|
| Supply voltage | 24 VDC (+10/-15%) |
| Rated impulse withstand voltage Uimp | 1 kV |
| Power consumption (incl. OSSD outputs) | 17 W |
| Rated current (on 24 VDC) | 645 mA |
| No-load current I0 | 60 mA |
| Amount safety inputs | 1x 2-channels |
| Current consumption per input max. | 2,75 mA |
| Current consumption input magnet ON | 1,2 mA |
| Voltage drop safety output (Ud) | 0,75 V |
| Amount OSSD safety output | 1x 2-channels |
| Safety output - output type | Transistor (PNP) |
| Residual current safety output (Ir) | 0,5 mA |
| Load capacitive reactance safety output max. | 20 nF |
| Amount diagnosis output | 1 |
| Diagnosis output- output type | Transistor (PNP) |
| Connection type | (Version HOLDX RL1-8P) M12 8-pin, Pigtail 200 mm |
| Series connection for safe In- and Outputs | max. 30 process locks |
| Protection class power supply | III |
| Switching current per diagnosis output max. | 100 mA |
| Design / Connections | 1x Pigtail 8-pin |
| Risk time | 75 ms ms |

Mechanical data

Dimensions

| | |
|-------|-------|
| Width | 34 mm |
|-------|-------|



Safety System Products

HOLDX RL1-P8-W-B

| | |
|---|---|
| Length | (without cable) 239,6 mm |
| Height | 31,1 mm |
| Dimensions of anchor plate | |
| Width of anchor plate | 34,4 mm |
| Length of anchor plate | 224,1 mm |
| Height of anchor plate | 20,1 mm |
| Locking force electromagnet | 1200 N |
| Permanent magnet | 50 N |
| Smart resting force | 0/ 30 N/ 50 N |
| Weight process lock | 725 g |
| Torque (mounting screw) process lock | 6 Nm |
| Torque (mounting screw) anchor plate | 6 Nm |
| Mounting | Screwing with raised head screw M6 Torx with pin |
| Material housing lock | PBT GF30, Aluminium eloxated black, AlMgSi, TPE, PC |
| Shock resistance | 30 g / 11 ms |
| Vibration resistance | 1 g, 5-150 Hz |
| Switching distance according to DIN EN 60947-5-3:2014-12 | |
| Assured switching distance ON $S(a_o)$ | 4 mm |
| Assured switching distance OFF $S(a_r)$ | 15 mm |
| Minimum switching distance S_{0min} | 0,5 mm |
| Typical switching distance $S(n)$ | 5 mm |
| Repeat accuracy R switching distance | <0,5 mm |
| Hysteresis | 2 mm |
| Generall periods | |
| Readiness delay $t(v)$ | 3000 ms |
| Start delay accuator $t(on)$ | 75 ms |
| Safety function times | |
| Switch-off reaction time inputs | max.3 ms |
| Switch-off reaction time anchor plate - Outputs $t(off)$ | max. 75 ms |
| Test impulse length OSSD Sicherheitsausgänge | 0,3 ms |

HOLDX RL1-P8-W-B

Electrical drawings

Connection drawing

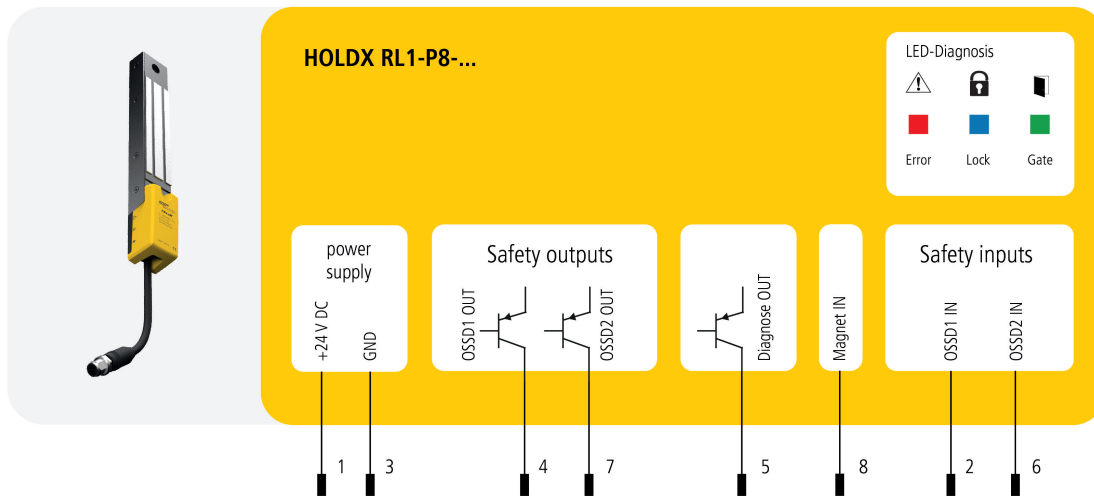

HOLDX RL1-P8-W-B

Connection example 1

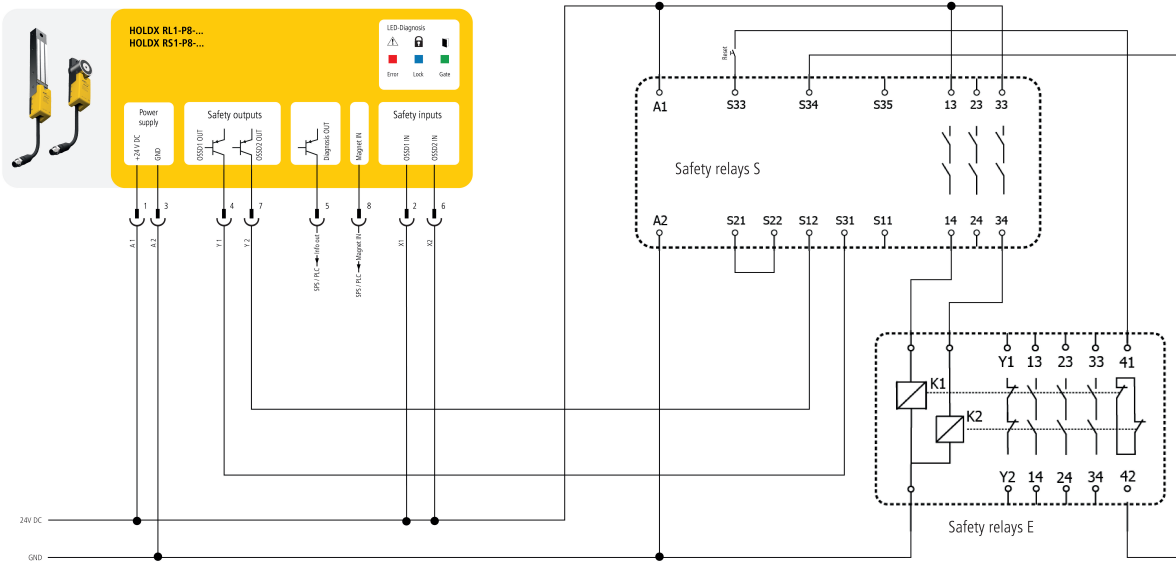

HOLDX RL1-P8-W-B

Connection example 2

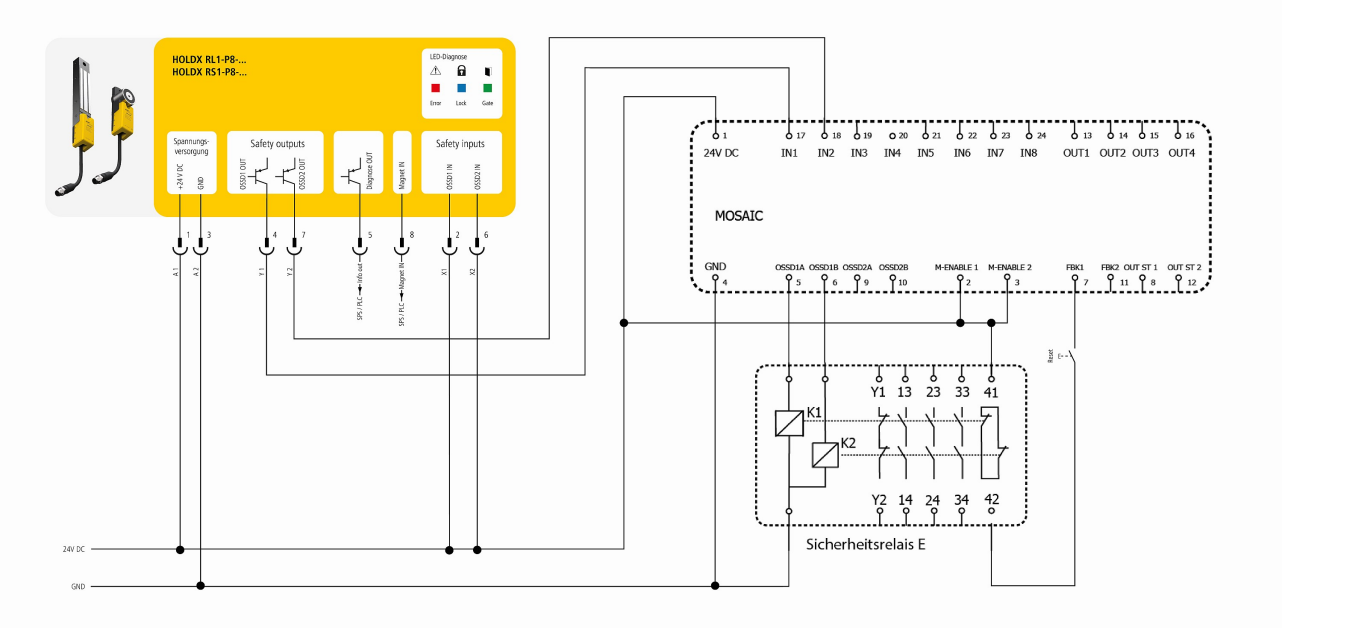

HOLDX RL1-P8-W-B

Connection example 3

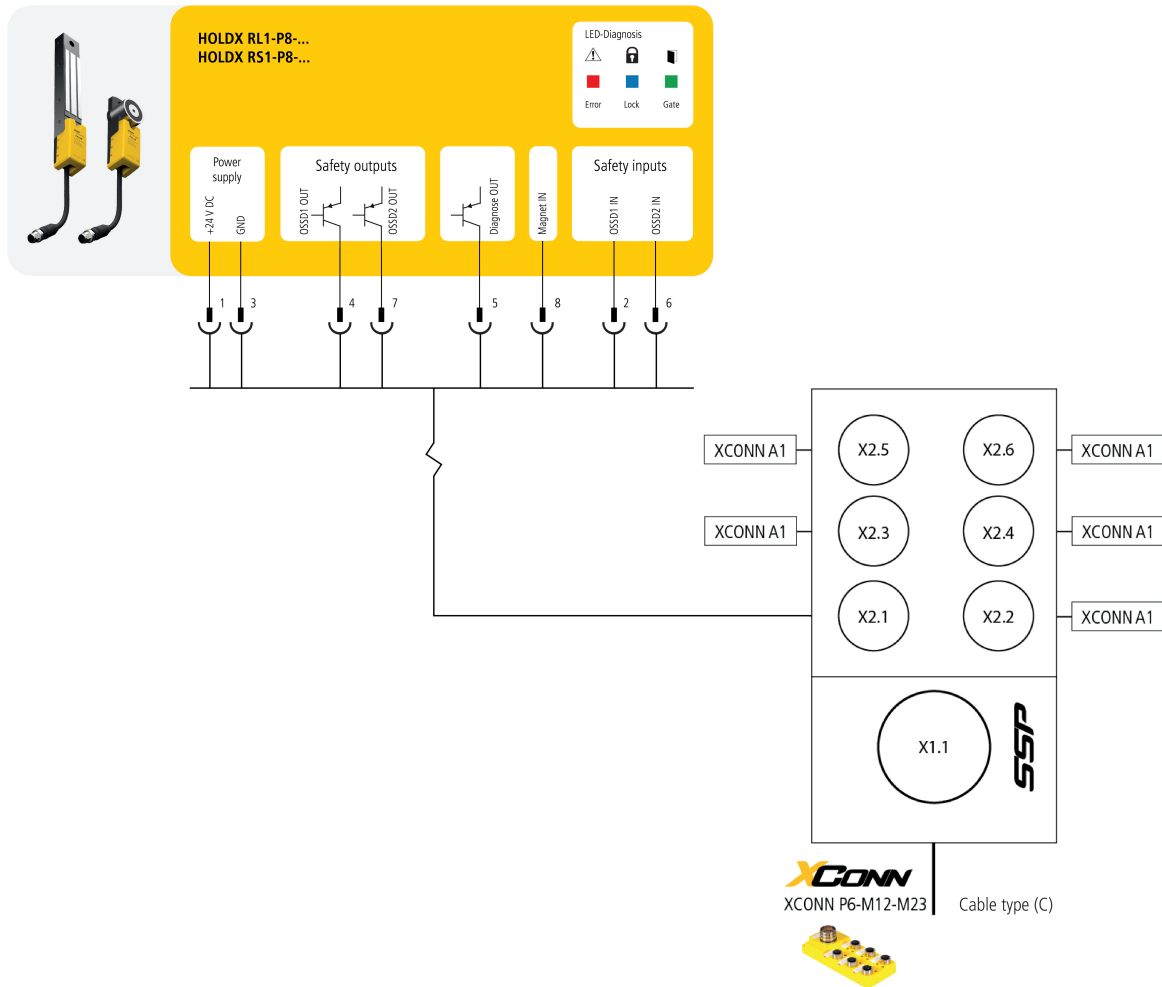

HOLDX RL1-P8-W-B

Connection example 4

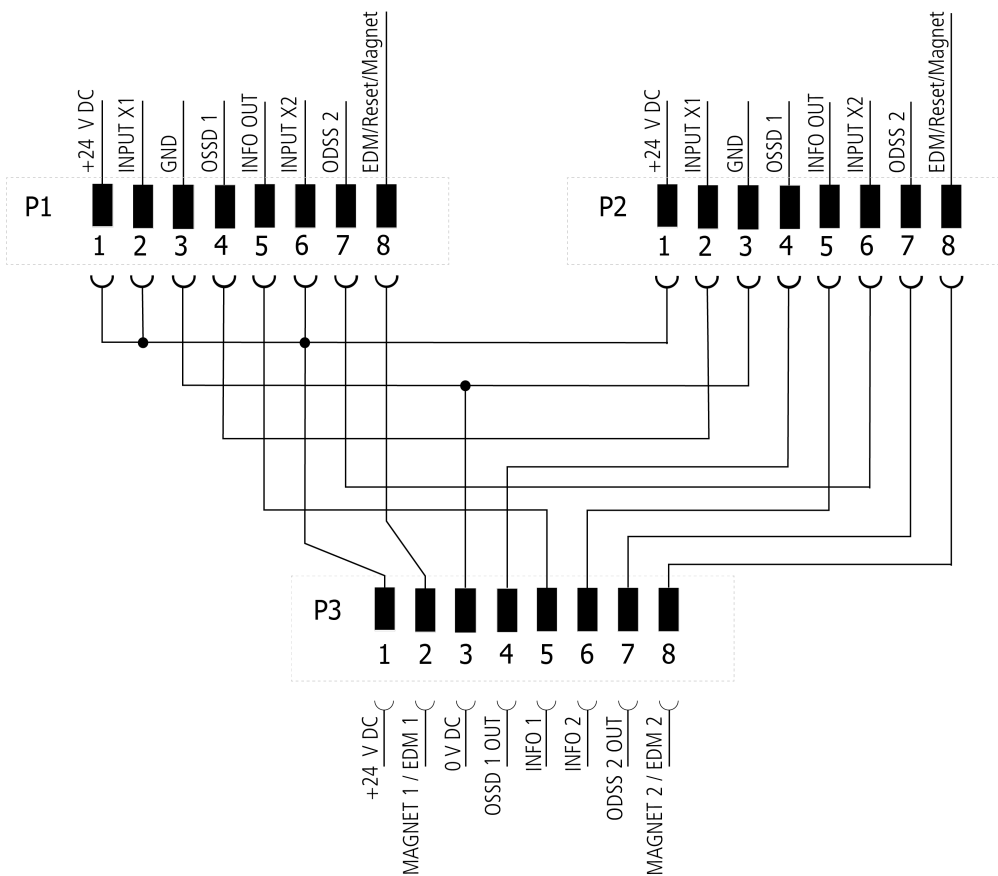

HOLDX RL1-P8-W-B

Drawings

Approach

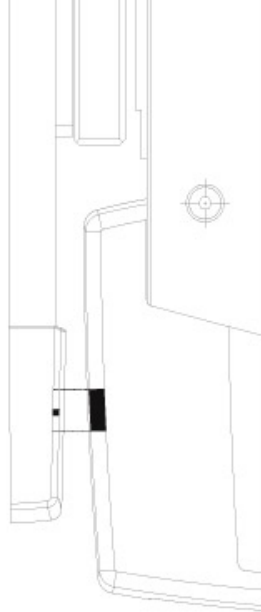

Switching gap

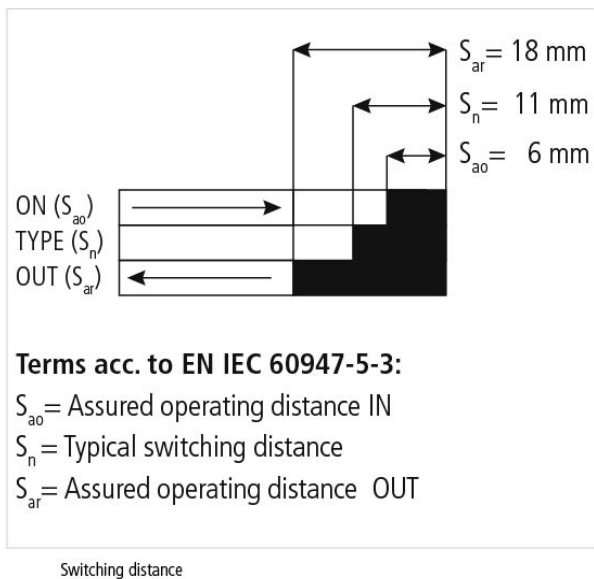

HOLDX RL1-P8-W-B

Approach direction

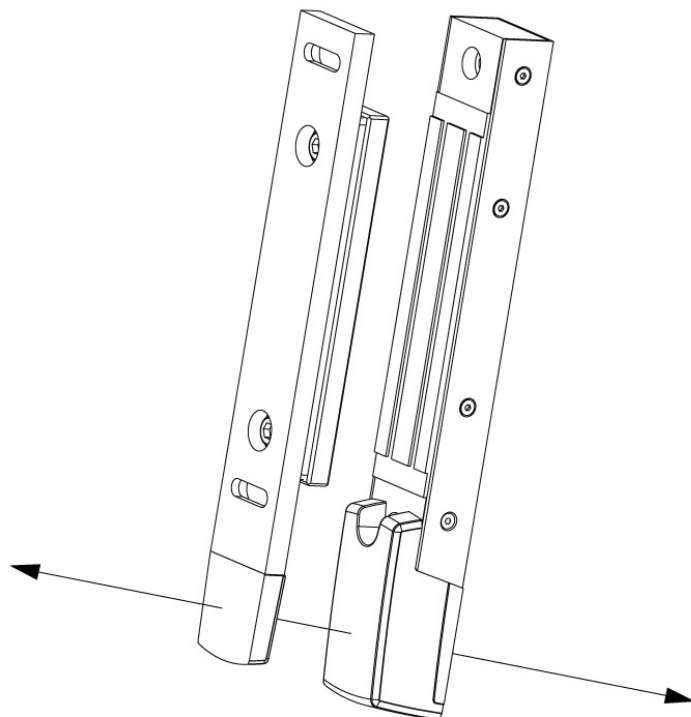

HOLDX RL1-P8-W-B

Assembly

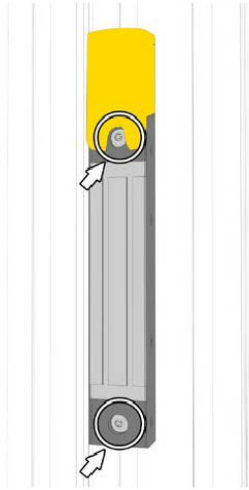

Fig.4: Attach the process guard locking to the profile at the desired height and tighten the Torx screws M6 x 25 mm.

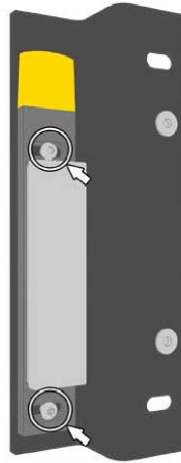

Fig.5: Attach the anchor plate to the mounting plate and tighten the Torx screws M6 x 8 mm.

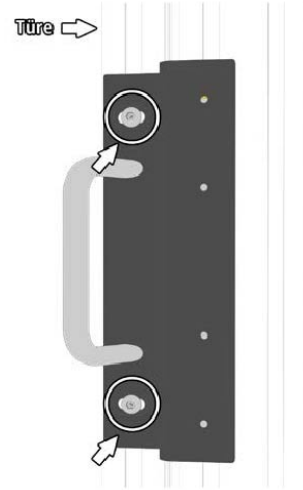

Fig.6: Attach the mounting plate with the anchor plate to the profile and align with the process guard locking. Tighten the Torx screws M8 x 12 mm.

Assembly 2

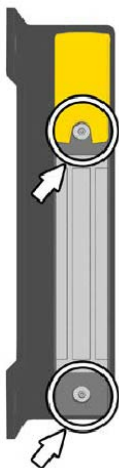

Fig.7: Attach the process guard locking to the mounting plate and tighten the Torx screws M6 x 25 mm.

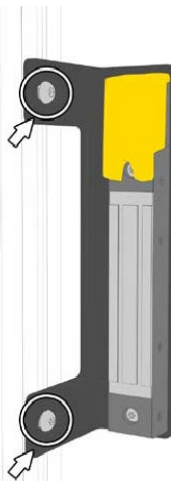

Fig.8: Attach the mounting plate with the process guard locking to the profile and tighten the Torx screws M8 x 12 mm.

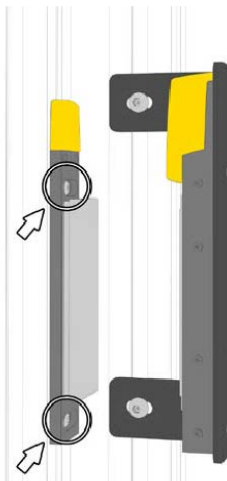

Fig.9: Attach the anchor plate to the profile of the sliding door and align it with the process guard locking. Tighten the Torx screws M6 x 10 mm.

Equipment

Accessories

HOLDX RL1-P8-W-B

M12-female connector, 8 pin, 10 m

C8D10

SP-R-13-309-81



M12-female connector, 8 pin, 15 m

C8D15

SP-R-13-309-82



M12-female connector, 8 pin, 25 m

C8D25

SP-R-13-309-67



M12-female connector, 8 pin, 40 m

C8D40

SP-R-13-309-66



M12-female connector, 8 pin, 5 m

C8D5

SP-R-13-309-80



Safety switches

Free software for magnetic guard lock HOLDX R

HOLDX Manager



Anchorplate with RFID tag and with 50N permanent magnet

HOLDX RL-A1

SP-X-71-001-40









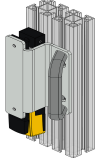

Anchorplate with RFID tag without additional permanent magnet

HOLDX RL-A2

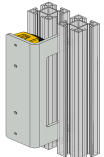
SP-X-71-001-41











HOLDX RL1-P8-W-B

| | | | |
|--|------------------|----------------|---|
| Mounting fitting HOLDX RL for wing doors with handle | HOLDX RL-Z-MF1 | SP-X-71-002-00 |  |
| Mounting fitting HOLDX RL for wing doors | HOLDX RL-Z-MF2 | SP-X-71-002-08 |  |
| Mounting fitting HOLDX RL for sliding doors | HOLDX RL-Z-MS1 | SP-X-71-002-01 |  |
| Passive distributor | XCONN P6-M12-10m | SP-X-71-000-04 |  |
| Passive distributor | XCONN P6-M12-M23 | SP-X-71-000-01 |  |
| Y distributor | XCONN Y2-M12 | SP-X-33-000-71 |  |
| Connection module for EDI D1B | XCONN Y3-M12 | SP-X-33-000-75 |  |
| Connection module EDI C7 | XCONN Y4-M12 | SP-X-33-000-76 |  |

Safe control technology





HOLDX RL1-P8-W-B

| | | | |
|---|---|----------------|---|
| | MOSAIC M1 | SP-R-11-000-00 |  |
| Standard safety relay 1 safety function | S2 series | SP-K-70-001-00 |  |
| Wireless Safety | | | |
| Safety Simplifier for HOLDX R1 | S14LDRB-H08-E2-I1-Q1A0-Q 2A0-Q3C0-Q4I0-W06 | SP-X-89-000-46 |  |
| Safety Simplifier for two HOLDX R1 | S14LDRB-H08-E2-I1-Q1A0-Q 2I0-Q3C0-Q4I0-W10 | SP-X-89-000-50 |  |
| Safety Simplifier for HOLDX R1 | S14LDRB-H09-E2-I1-I1-Q1A0- Q2A0-Q3C0-Q4I0-W07 | SP-X-89-000-47 |  |
| Safety Simplifier for two HOLDX R1 | S14LDRB-H09-E2-I1-I1-Q1A0- Q2I0-Q3C0-Q4I0-W11 | SP-X-89-000-51 |  |
| Safety Simplifier for HOLDX R1 | S14LDRB-H0A-E2-I1-I1-I1-Q1 A0-Q2A0-Q3C0-Q4I0-W08 | SP-X-89-000-48 |  |
| Safety Simplifier for two HOLDX R1 | S14LDRB-H0A-E2-I1-I1-I1-Q1 A0-Q2I0-Q3C0-Q4I0-W12 | SP-X-89-000-52 |  |



Safety System Products

HOLDX RL1-P8-W-B

| | | | |
|--|---|----------------|---|
| Safety Simplifier for HOLDX R1 | S14LDRB-H0A-E2-I1-I1-K8-Q1 A0-Q2I0-Q3C0-Q4I0-W09 | SP-X-89-000-49 |  |
| Safety Simplifier for two HOLDX R1 | S16LDRB-H0A-E2-I1-I1-K8-Q1 A0-Q2I0-Q3C0-Q4I0-W13 | SP-X-89-000-53 |  |
| Safety Simplifier Standard Module wireless passive distributor | S16LDRB-H10-Q1A0-Q2A0-Q 3C0-Q4A0-Q5U0-Q6U0-Q7U 0-Q8U0-W36 | SP-X-89-100-06 |  |
| Passive distributor | XCONN P6-M12-5m | SP-X-71-000-00 |  |
| Y-distributor | XCONN Y1-M12 | SP-X-71-000-02 |  |

Downloads

- Operating manual
- Software Gateway
- Product line
- Catalog
- Catalog packaging systems
- Certificate UL
- Certificate
- SISTEMA - Data V 4.1
- EPLAN-Data
- CAD Data

we simplify safety