

UT M30 CYLINDRICAL ULTRASONIC SENSOR

Installation manual - CAT8EUT1996301 - ENG - Created: 13/06/2019

TECHNICAL SPECIFICATIONS

	UT1B	UT2F	UT5L
maximum sensing distance	3,500 mm ⁽¹⁾	6,000 mm ⁽²⁾	8,000 mm ⁽³⁾
minimum sensing distance	250 mm	350 mm	600 mm
sensing range (Sd)	250...3,500 mm	350...6,000 mm	600...8,000 mm
beam angle	12° ± 2°	15° ± 2°	10° ± 2°
switching frequency (digital output)	1 Hz		
hysteresis	1%		
repeatability	0.1%		
resolution	0.1%		
linearity error	1%		
temperature range	- 20°C...+ 70°C		
temperature compensation	●		
operating voltage	10 - 30 Vcc		
temperature drift	± 5%		
ripple	5%		
leakage current	10 µA @ 30 Vcc		
output voltage drop	2.2 V max. (IL = 100 mA)		
no-load supply current	25 mA		
output current (digital output)	100 mA		
minimum load resistance (analog voltage output)	3 k Ω		
set point adjustment	Teach-In button		
power on delay (digital output)	≤ 400 ms	≤ 800 ms	
short-circuit protection	● (autoreset)		
induction protection	●		
voltage reversal protection	●		
EMC	conforming to EMC Directive, according to EN 60947-5-2		
protection degree	IP67 (EN60529) ⁽⁴⁾		
housing material	PBT/stainless steel AISI 316L		
active head material	Epoxy-Glass resin		
tightening torque	1,5 Nm (plastic); 100 Nm (metallic)	1,5 Nm (plastic)	100 Nm
weight	plastic: 85 g connector / 150 g cable metallic: 150 g connector	115 g connector	350 g
storage temperature	- 30°C...+ 80° without freezing		
LEDs	green: echo - yellow: output		

⁽¹⁾ Metallic target 200 x 200 mm ⁽²⁾ Metallic target 400 x 400 mm ⁽³⁾ Metallic target 1000 x 1000 mm
⁽⁴⁾ Protection guarantee only with plug cable well mounted

INSTALLATION CONDITION

The installation of the sensor has to be done using nuts and flexible washers supplied with ultrasonic sensor (see Supplied Material) (standard condition). In the case of non-standard installation conditions, as for example, sensor fixed directly into metal block through threaded or not-threaded hole or using metallic nuts, both metallic block and nuts have to be connected to ground. Moreover, both nut and metallic block have to be minimum 5 mm from the edge of the active face and it is necessary that the first 5 mm of threaded housing are not screwed.

STATES PRESERVATION

The sensor preserves the last adjustment made, therefore removing the voltage supply and restoring it, the sensor works in according to last value of P1 and P2 point.

ATTENTION

Make sure that the supply voltage is correctly set with a ripple corresponding to the values indicated on the catalogue. In case of the noise produced by the power lines exceeds the values foreseen by the EMC directive (interference immunity), separate the sensor cables from both the power and high tension lines and insert it in a grounding metal raceway. Moreover it is advisable to connect the sensor directly to the supply source and not to other devices. To extend the supply and output cables, it is necessary to use a cable having conductors with a minimum size of 1 mm². The maximum length of extension is 100 m (this value is referred to a minimum tension and power supply at the load of 100 mA). In industrial environments, we recommend to use shielded cables in order to prevent possible disturbances on the devices caused by electromagnetic fields induced. Do not expose sensor head to hot water > 50 °C, water steam, acids or solvents. Clean the active face of the sensor with a wet cloth and then dry it. If the sensor is measuring across a temperature gradient, the compensation will be less effective. The temperature warm up drift upon power-up influence the measurement of the sensing distance. After 20 minutes, the sensing distance will be stable.

CHARACTERISTIC CURVES

UT1B

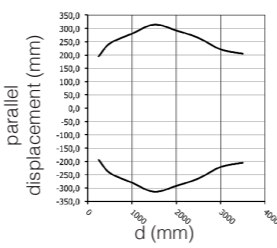

UT2F

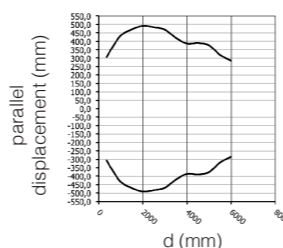

UT5L

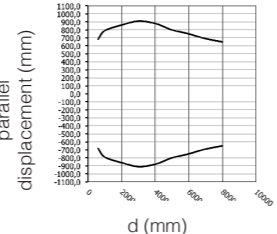

PLUGS

M12

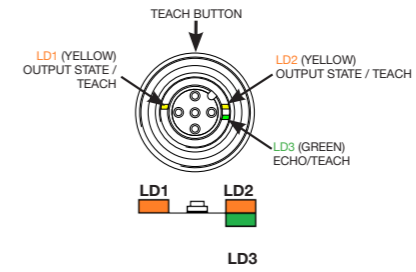
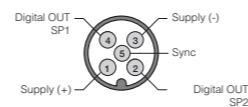

SUPPLIED MATERIAL

- Installation manual
- 2 plastic nuts SW36, h 10 mm (plastic version)
- 2 flexible washers (plastic version)
- 2 metallic nuts SW36, h 5 mm (metallic version)

ELECTRICAL DIAGRAMS OF THE CONNECTIONS

PNP models with double output

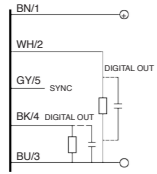

In case of combined load, resistive and capacitive, the maximum admissible capacity (C) is 0,1 µF for maximum output voltage and current.

KEY: BN = brown; BK = black; BU = blue; WH = white; GY = grey

DIMENSIONS

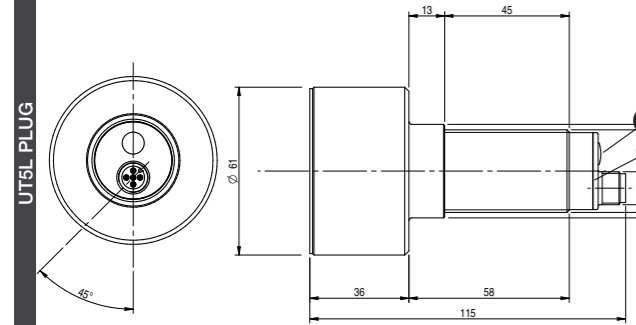
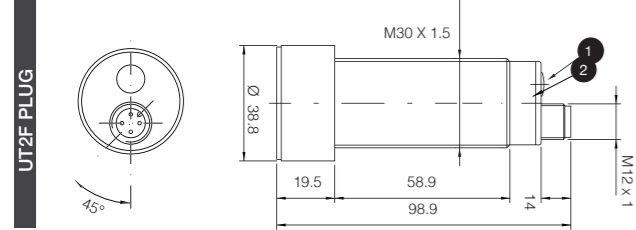
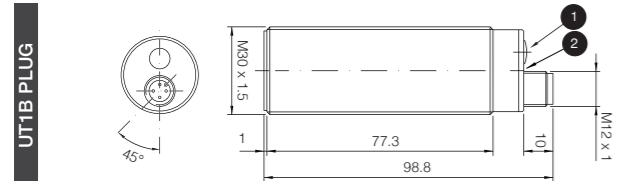
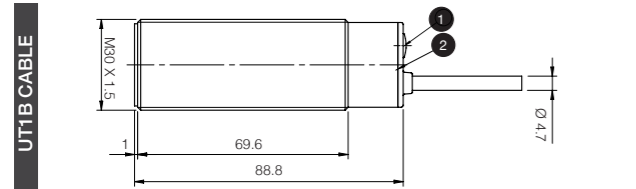

DOUBLE DIGITAL OUTPUT MODELS

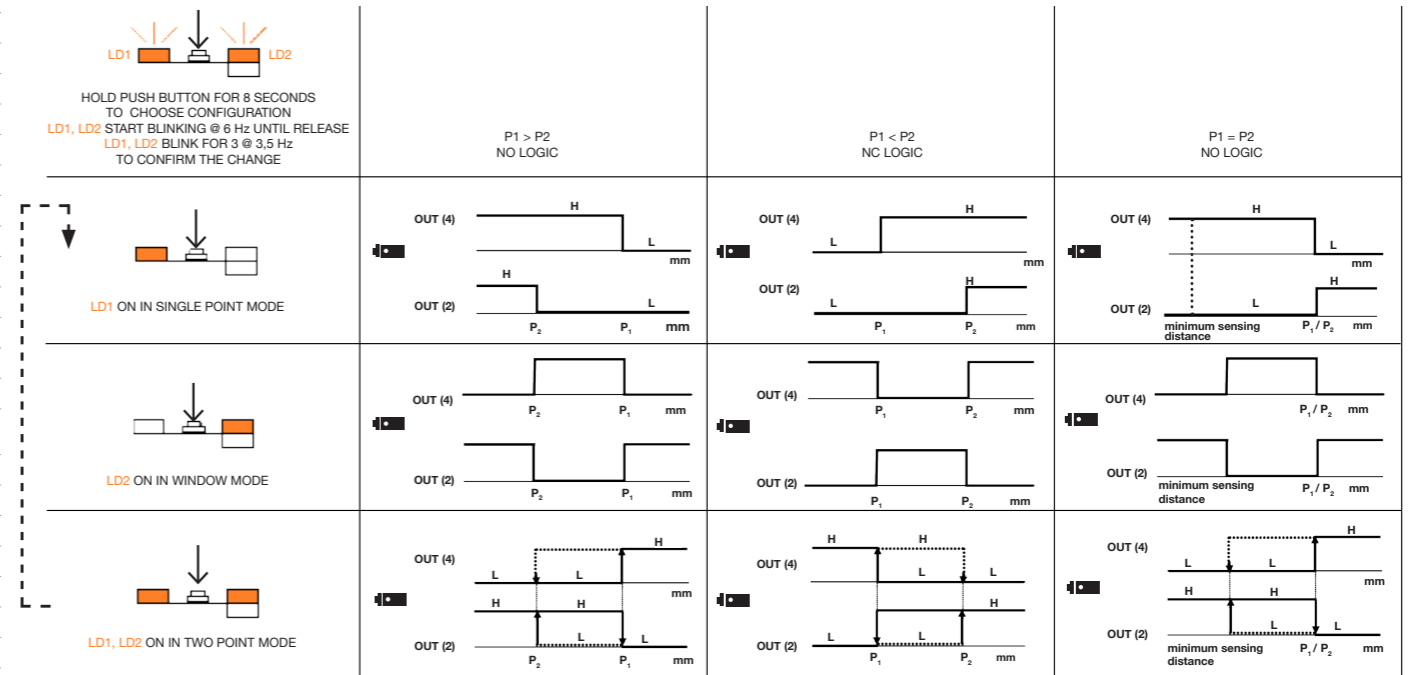

FW IDENTIFICATION

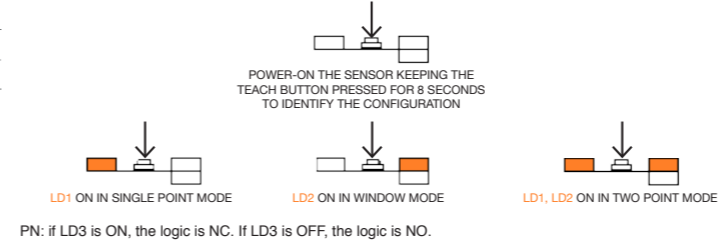

SYNC/MUX

Synchronization
 In this condition all the sensors are linked together and they work and measure at the same time. To enable this functionality, the sync-pin of all the sensors have to be connected together and then the system has to be power-on. The target has to be flat and at the same distance from all the sensors; this condition is mandatory to let the sensors work properly.

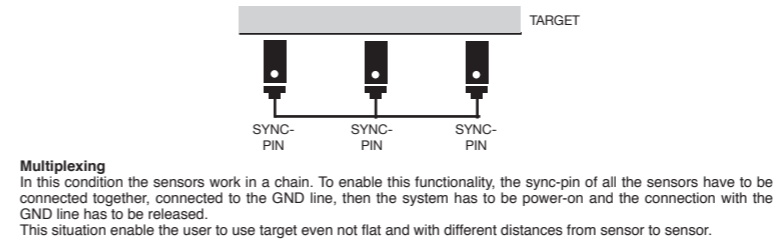

Multiplexing
 In this condition the sensors work in a chain. To enable this functionality, the sync-pin of all the sensors have to be connected together, connected to the GND line, then the system has to be power-on and the connection with the GND line has to be released. This situation enable the user to use target even not flat and with different distances from sensor to sensor.

The sensors must be individually adjusted before the Sync/Mux connections.

WARNING These products are NOT safety sensors and are NOT suitable for use in personnel safety application

Declaration of conformity
 M.D. Micro Detectors S.p.A. con Unico Socio declare under our sole responsibility that these products are in conformity with the following EMC directive.

RESTORE PROCEDURE

Restore of SP1 and SP2 to default values. Press the teach button without the target on P1. The yellow LD1 and LD2 blink 5 times @3.5Hz to show the success of this procedure. This restore involve only MAX_SP1 and MIN_SP2; logic (NO/NC) and functioning mode are not affected (Exception: performing this restore type in Single Point Mode, the logic will be always NO)

Full Restore of the Factory Calibration Data. Press the teach button without the target on P2 after the proper acquisition of P1. The green LD3 blink 5 times @3.5Hz to show the success of this procedure. This restore re-set MAX_SP1 and MIN_SP2, logic (NO) and set the single point mode.

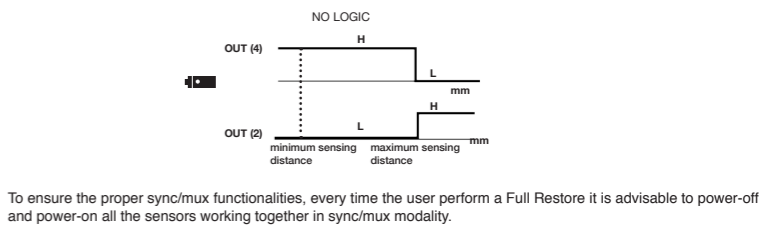

TEACH BLOCK

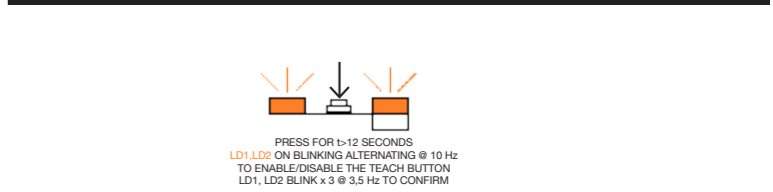

ERROR CONDITIONS

Teaching under the limit or over the limit of the sensing range is not allowed. In this condition, no lamping will be shown, means error occurred.

M.D. Micro Detectors S.p.A. con Unico Socio
 Strada S. Caterina, 235 - 41122 Modena Italy
 Tel. +39 059 420411 Fax +39 059 253973
 www.microdetectors.com
 info@microdetectors.com

Micro Detectors
 Italian Sensors Technology