



**EN** Operating instructions. . . . . pages 1 bis 12  
Original

**Content**

**1 About this document**

1.1 Function . . . . . 1

1.2 Target group: authorised qualified personnel. . . . . 1

1.3 Explanation of the symbols used . . . . . 1

1.4 Appropriate use . . . . . 2

1.5 General safety instructions . . . . . 2

1.6 Warning about misuse . . . . . 2

1.7 Exclusion of liability . . . . . 2

**2 Product description**

2.1 Ordering code . . . . . 2

2.2 Special versions. . . . . 2

2.3 Purpose . . . . . 2

2.4 Technical data . . . . . 3

2.5 Derating / electrical lifespan of safety contacts . . . . . 3

2.6 Safety classification . . . . . 4

**3 Mounting**

3.1 General mounting instructions . . . . . 4

3.2 Dimensions . . . . . 4

**4 Electrical connection**

4.1 General information for electrical connection. . . . . 4

4.2 Coding of connecting terminals . . . . . 4

**5 Operating principle and settings**

5.1 Description of the terminals and LED indications . . . . . 5

5.2 Adjustable applications . . . . . 6

5.3 Changing setting or application . . . . . 6

**6 Diagnostic**

6.1 LED indications . . . . . 7

6.2 Faults . . . . . 7

**7 Wiring examples**

7.1 Possible applications . . . . . 7

7.2 Application example. . . . . 8

7.3 Start configuration . . . . . 9

7.4 Feedback circuit / Release signal . . . . . 9

7.5 Sensor configuration . . . . . 9

**8 Set-up and maintenance**

8.1 Commissioning . . . . . 10

8.2 Functional testing. . . . . 10

8.3 Behaviour in the case of faults. . . . . 10

8.4 Setting report . . . . . 10

8.5 Maintenance . . . . . 11

**9 Disassembly and disposal**

9.1 Disassembly. . . . . 11

9.2 Disposal . . . . . 11

**10 Appendix**

10.1 Wiring/circuit information. . . . . 11

**11 EU Declaration of conformity**

**1. About this document**

**1.1 Function**

This operating instructions manual provides all the information you need for the mounting, set-up and commissioning for the safe operation and disassembly of the safety relay module. The operating instructions must be available in a legible condition and a complete version in the vicinity of the device.

**1.2 Target group: authorised qualified personnel**

All operations described in this operating instructions manual must be carried out by trained specialist personnel, authorised by the plant operator only.

Please make sure that you have read and understood these operating instructions and that you know all applicable legislations regarding occupational safety and accident prevention prior to installation and putting the component into operation.

The machine builder must carefully select the harmonised standards to be complied with as well as other technical specifications for the selection, mounting and integration of the components.

**1.3 Explanation of the symbols used**

 **Information, hint, note:**  
This symbol indicates useful additional information.

 **Caution:** Failure to comply with this warning notice could lead to failures or malfunctions.  
**Warning:** Failure to comply with this warning notice could lead to physical injury and/or damage to the machine.

### 1.4 Appropriate use

The Schmersal range of products is not intended for private consumers.

The products described in these operating instructions are developed to execute safety-related functions as part of an entire plant or machine. It is the responsibility of the manufacturer of a machine or plant to ensure the correct functionality of the entire machine or plant.

The safety relay module must be exclusively used in accordance with the versions listed below or for the applications authorised by the manufacturer. Detailed information regarding the range of applications can be found in the chapter "Product description".

### 1.5 General safety instructions

The user must observe the safety instructions in this operating instructions manual, the country specific installation standards as well as all prevailing safety regulations and accident prevention rules.



Further technical information can be found in the Schmersal catalogues or in the online catalogue on the Internet: [products.schmersal.com](http://products.schmersal.com).

The information contained in this operating instructions manual is provided without liability and is subject to technical modifications.

### 1.6 Warning about misuse



In case of inadequate or improper use or manipulations of the safety relay module, personal hazards or damage to machinery or plant components cannot be excluded.

### 1.7 Exclusion of liability

We shall accept no liability for damages and malfunctions resulting from defective mounting or failure to comply with this operating instructions manual. The manufacturer shall accept no liability for damages resulting from the use of unauthorised spare parts or accessories.

For safety reasons, invasive work on the device as well as arbitrary repairs, conversions and modifications to the device are strictly forbidden, the manufacturer shall accept no liability for damages resulting from such invasive work, arbitrary repairs, conversions and/or modifications to the device.

The safety relay module is to be operated in an area in which access by personnel is restricted.

## 2. Product description

### 2.1 Ordering code

This operating instructions manual applies to the following types:

**SRB-E-212ST-①**

**SRB-E-322ST-①**

No.	Option	Description
①		Plug-in screw clamps: single wire (rigid) or fine wire (flexible): 0.2 ... 2.5 mm <sup>2</sup> ; fine wire with ferrule: 0.25 ... 2.5 mm <sup>2</sup>
	CC	Plug-in cage clamps: single wire (rigid) or fine wire (flexible): 0.2 ... 1.5 mm <sup>2</sup> ; fine wire with ferrule: 0.25 ... 1.5 mm <sup>2</sup>
	CC2	Plug-in cage clamps: two row, single wire (rigid) or fine wire (flexible): 0.2 ... 1.5 mm <sup>2</sup> ; fine wire with ferrule: 0.25 ... 1.5 mm <sup>2</sup>



Only if the action described in these operating instructions is carried out correctly will the safety function be safeguarded, including compliance with the Machinery Directive.

### 2.2 Special versions

For special versions, which are not listed in the ordering code below 2.1, these specifications apply accordingly, provided that they correspond to the standard version.

### 2.3 Purpose

The safety relay modules for integration in safety circuits are designed for fitting in control cabinets. They are used for the safe evaluation of the signals of positive break position switches for safety functions or safety sensors for safety functions on sliding, hinged and removable safety guards as well as emergency stop control devices, safety mats, two-hand control devices, magnetic safety switches and AOPDs.

The safety function is defined as deactivating outputs Qt1, Qt2 and 13/14, 23/24, 33/34 when inputs S12 and/or S22 and/or X3 are opened. Taking account of a PFH value assessment, the safety-relevant current paths meet the following requirements (see also chapter 2.6 "Safety classification"):

- Category 4 - PL e to EN ISO 13849-1
- SIL 3 to IEC 61508
- SIL CL 3 to EN 62061

To determine the Performance Level (PL) to EN ISO 13849-1 of the entire safety function (e.g. sensor, logic, actuator), an assessment of all relevant components is required.



The entire concept of the control system, in which the safety component is integrated, must be validated to the relevant standards.

There are no residual risks, provided that the safety instructions as well as the instructions regarding mounting, commissioning, operation and maintenance are observed.

### 2.4 Technical data

#### General data

Standards:	EN 60204-1, EN 60947-5-1, EN ISO 13851, EN ISO 13849-1, IEC 61508, EN 62061
EMC rating:	to EMC Directive
Air clearances and creepage distances:	to EN 60664-1
Mounting:	standard rail to EN 60715
Terminal designations:	EN 60947-1

#### Electrical characteristics:

Rated operating voltage $U_e$ :	24 VDC $-20\%/+20\%$ , residual ripple max. 10%
---------------------------------	--

Mains adapter/power supply: An ES1 or PELV/SELV mains adapter must be used as a voltage source or be ensured by means of additional measures so that the output voltage of the power adapter in the event of an error does not exceed 60 V. Mains power supply must harmonise with device safety (characteristic/melting property) so that triggering is ensured.

Power consumption:	3 W (+ load of the safety outputs)
--------------------	------------------------------------

Fuse rating for the operating voltage: we recommend a circuit breaker type Z (max. 16 A) or a fine fuse (max. 15 A, delayed action)

UL Rating of external fuse:	max. 16 A, only use fuses in accordance with UL 248 series
-----------------------------	--

Insulation values to IEC 60664-1:

Rated insulation voltage $U_i$ :	
----------------------------------	--

- safety contacts:	250 V
--------------------	-------

- safety outputs:	50 V
-------------------	------

Rated impulse withstand voltage $U_{imp}$ :	
---	--

- safety contacts 13-14, 23-24:	6 kV
---------------------------------	------

- safety contact 33-34:	4 kV
-------------------------	------

- safety outputs:	0.8 kV
-------------------	--------

Overvoltage category:	III
-----------------------	-----

Degree of pollution:	2
----------------------	---

Pull-in delay:	< 150 ms
----------------	----------

Drop-out delay in case of "emergency stop":	< 10 ms
---	---------

Drop-out delay on "supply failure":	< 10 ms
-------------------------------------	---------

Response time $t_r$ :	< 10 ms
-----------------------	---------

Bridging in case of voltage drops:	typ. 5 ms
------------------------------------	-----------

Readiness after switching on voltage:	< 1.5 s
---------------------------------------	---------

#### Control current circuits/inputs:

Inputs S12, S22:	24 VDC / 8 mA
------------------	---------------

Inputs X2, X3, X7:	24 VDC / 8 mA
--------------------	---------------

Clock outputs S11, S21:	> 20 VDC, 10 mA per output
-------------------------	----------------------------

Cable length:	1,500 m with 1.5 mm <sup>2</sup> , 2,500 m with 2.5 mm <sup>2</sup>
---------------	--

Conduction resistance:	max. 40 $\Omega$
------------------------	------------------

#### Relay outputs:

Switching capacity of the safety contacts:	13-14, 23-24, 33-34: max. 250 V, 6 A ohmic, min. 10 VDC / 10 mA (Derating see 2.5)
--	---

Fuse rating of the safety contacts:	external ( $I_k = 1000$ A) to EN 60947-5-1
-------------------------------------	---

Safety fuse 10 A quick blow, 6 A slow blow

Utilisation category to EN 60947-5-1:	AC-15: 230 V / 4 A
---------------------------------------	--------------------

	DC-13: 24 V / 4 A
--	-------------------

Switching capacity of the auxiliary contacts:	41-42: 24 VDC / 1 A
---	---------------------

Fuse rating for the auxiliary contact:	safety fuse
--	-------------

2.5 A quick blow, 2 A slow blow

Safety contact values:	resistance max. 100 m $\Omega$ , AgNi, self-cleaning, positive action
------------------------	--

Electrical life:	refer to 2.5
------------------	--------------

Mechanical life:	10 million operations
------------------	-----------------------

#### Semi-conductor outputs:

Switching capacity of the safety outputs:	Qt1, Qt2: max. 2 A
---	--------------------

Voltage drop:	< 0.5 V
---------------	---------

Leakage current:	< 1 mA
------------------	--------

Max. fuse rating of the safety outputs:	refer to "Operating voltage"
---	------------------------------

Test impulse of the safety outputs:	< 1 ms (negative), < 100 $\mu$ s (positive)
-------------------------------------	--

Utilisation category to EN 60947-5-1:	DC-13: 24 V / 2 A
---------------------------------------	-------------------

Switching capacity of signaling outputs:	semi-conductor outputs Y1, Y2: 24 VDC/100 mA
--	---

Fuse rating of the signalling outputs:	internal electronic trip, tripping current > 100 mA
--	--

Electrical life:	Derating refer to 2.5
------------------	-----------------------

Mechanical life:	10 million operations
------------------	-----------------------

Max. switching cycles / minute:	20
---------------------------------	----

Inductive consumers:	provision is to be made for suitable protective wiring for suppression
----------------------	---

#### Mechanical data:

Connection type:	refer to 2.1
------------------	--------------

Cable section:	refer to 2.1
----------------	--------------

Connecting cable:	rigid or flexible
-------------------	-------------------

Tightening torque for the terminals:	0.5 Nm
--------------------------------------	--------

Material of enclosure:	glass-fibre reinforced thermoplastic, ventilated
------------------------	--

Weight:	180 g
---------	-------

#### Ambient conditions:

Ambient temperature:	$-25^{\circ}\text{C} \dots +60^{\circ}\text{C}$ (non condensing)
----------------------	---

Storage and transport temperature:	$-40^{\circ}\text{C} \dots +85^{\circ}\text{C}$ (non condensing)
------------------------------------	---

Degree of protection:	Enclosure: IP20 Terminals: IP20 Clearance: IP54
-----------------------	---

Resistance to shock:	30 g / 11 ms
----------------------	--------------

Resistance to vibration in accordance with EN 60068-2-6:	10 ... 55 Hz, Amplitude 0.35 mm
--	------------------------------------

Altitude:	max. 2,000 m
-----------	--------------

### 2.5 Derating / electrical lifespan of safety contacts

#### SRB-E-212ST / SRB-E-322ST

No derating with individual installation of safety relay modules.

Derating on request if several modules are installed one after the other without spacing and with maximum output load and ambient temperatures.

#### Electrical life of the safety contacts

##### Operations

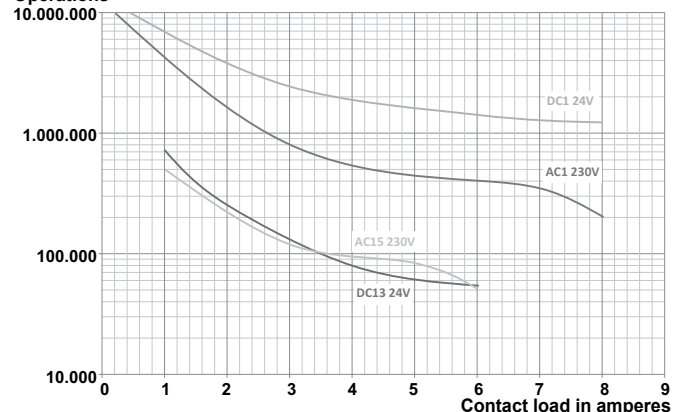

2.6 Safety classification

2.6.1 Safety classification of semi-conductor output

Standards:	EN ISO 13849-1, IEC 61508, EN 62061
PL:	e
Control Category:	4
PFH <sub>D</sub> :	≤ 2.66 x 10 <sup>-9</sup> / h
PFD <sub>avg</sub> :	≤ 2.42 x 10 <sup>-5</sup>
SIL:	suitable for SIL 3 applications
Mission time:	20 years

2.6.2 Classification of relay output

Standards:	EN ISO 13849-1, IEC 61508, EN 62061
PL:	e
Control Category:	4
DC:	high
CCF:	> 65 points
PFH <sub>D</sub> :	≤ 1.25 x 10 <sup>-8</sup> / h
PFD <sub>avg</sub> :	≤ 5.3 x 10 <sup>-5</sup>
SIL:	suitable for SIL 3 applications
Mission time:	20 years

The PFH value of 1.25 × 10<sup>-8</sup>/h applies to the combinations of contact load (current through enabling contacts) and number of switching cycles (n<sub>oply</sub>) mentioned in the table below. At 365 operating days per year and a 24-hours operation, this results in the below-mentioned switching cycle times (t<sub>cycle</sub>) for the relay contacts.

Contact load	n <sub>oply</sub>	t <sub>cycle</sub>
20 %	880,000	0.6 min
40 %	330,000	1.6 min
60 %	110,000	5.0 min
80 %	44,000	12.0 min
100 %	17,600	30.0 min

Diverging applications upon request.

3. Mounting

3.1 General mounting instructions

Mounting: snaps onto standard rails to EN 60715.

Hook bottom of enclosure in standard rail and push down until it engages in position.

3.2 Dimensions

Device dimensions (H/W/D): 98 x 22.5 x 115 mm

4. Electrical connection

4.1 General information for electrical connection



The electrical connection may only be carried out by authorised personnel in a de-energised condition.



If mains unit is a new installation or a replacement, the connector of the output level must be removed and correct connection of the power supply (A1) must be checked.



To avoid EMC disturbances, the physical ambient and operational conditions at the place where the product is installed, must meet the provisions laid down in the paragraph "Electromagnetic Compatibility (EMC)" of EN 60204-1.

Settle length x of the conductor:

- on screw terminals: 7 mm
- on cage clamps of type s or f: 10 mm
- on two-row cage clamps (CC2) of type s or f: 8 mm



4.2 Coding of connecting terminals

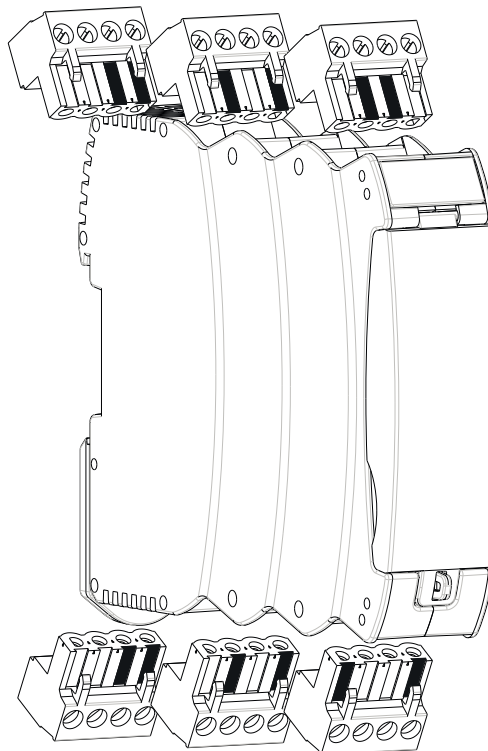

#### 5. Operating principle and settings

##### 5.1 Description of the terminals and LED indications

Clip	Function	LED	Function
A1	Operating voltage +24 VDC	<b>RUN</b>	Operating voltage OK RUN mode For flash code, see section 5.3
A2	Operating voltage 0 V	<b>ERR</b>	Error code refer to part 5.5
X2	Input start circuit/ Input two-hand		
X3	Input feedback circuit/ input two-hand		
X7	Input release signal/ feedback circuit for two hand		
S11/S21	Test pulse outputs		
S12	Input channel 1/ Input two hand	<b>In 1</b>	High level at S12 For flash code, see section 5.4
S22	Input channel 2/ Input two hand	<b>In 2</b>	High level at S22 For flash code, see section 5.4
Y1	Signalling output (NC) STOP 0		
Y2	Signalling output (NC) STOP 1		
41/42	Signalling contact (NC) STOP 0		
13/14, 23/24, 33/34	Safety outputs STOP 0	<b>Out 1</b>	Outputs activated For flash code, see section 5.4
Qt1/Qt2	Safety outputs STOP 1	<b>Out 2</b>	Outputs activated For flash code, see section 5.4

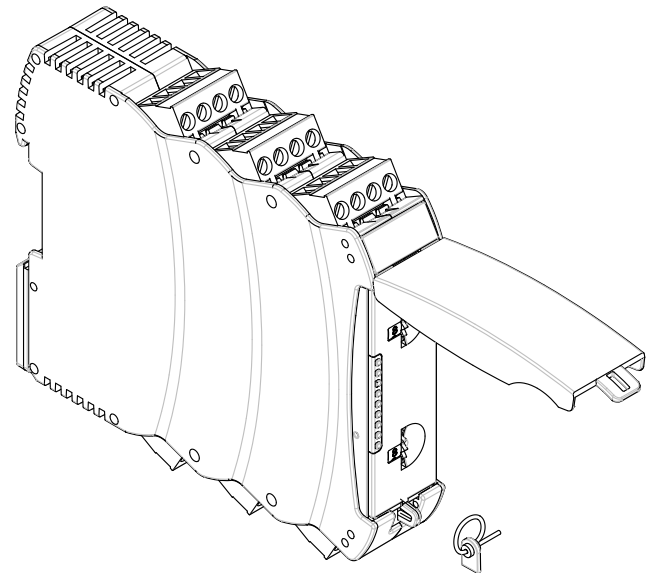

##### Adjustment of application using rotary "mode" switch

- Open front transparent cover (see fig.).
- Opening is carried out by lifting side with lock.
- Select desired application using rotary mode switch (1 ... 10) by turning up or down (see 5.3).
- Adjust drop-out delay (0 ... 30 sec.) with rotary time switch (16 increments) by turning up or down (see 5.3).
- After performing setting, close front cover again.
- Front cover can be secured with a lead seal to protect it from being opened unintentionally



Only touch the components after electrical discharge!

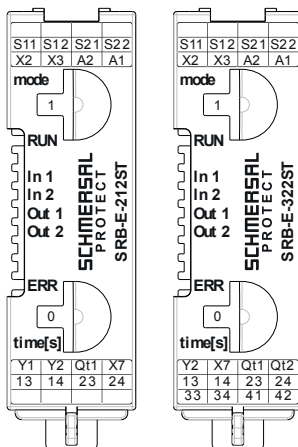

5.2 Adjustable applications

Rotary switch "time"

Drop-out delay in seconds			
0	2.0	5.0	15.0
0.5	2.5	8.5	20.0
1.0	3.0	10.0	25.0
1.5	4.0	12.0	30.0

Rotary switch "mode"

Rotary knob Position	Reset button (detection of the trailing edge)	Cross-wire monitoring active	Input/Sensor configuration	Monitoring of sensor channels for synchronisation (< 5 sec.)
1	Yes	Yes	NC / NC	Yes
2	Yes	Yes	NC / NC	No
3	Yes	No	NC / NC	Yes
4	Yes	No	NC / NC	No
5	Yes	Yes	NC / NO	Yes
6	Autostart	Yes	NC / NO	No
7	Autostart	Yes	NC / NC	Yes
8	Autostart	Yes	NC / NC	No
9	Autostart	No	NC / NC	Yes
10	Autostart	No	NC / NC	No
11	Function two-hand control type IIIC (only on SRB-E-212ST variant)		NC/NO, NC/NO	< 0.5 s (upon actuation of setting elements)
12	Two-hand function type IIIA (only on SRB-E-212ST variant)		NO / NO	< 0.5 s (upon actuation of setting elements)
C	<b>Configuration mode</b>			



With rotary knob positions 11 and 12 (two-hand function type IIIA/IIIC), a time delay (stop 1 function) can be set for safety output Qt1.

The response time  $t_r$  of the output Qt1 changes according to the setting.

See 5.2 table rotary knob "time"

If the safety output Qt1 is to switch off without time delay (stop 0 function), the rotary knob "time" must be set to 0 s.

5.3 Changing setting or application

Description / procedure	Rotary switch "mode"	Rotary switch "time"	System response	LED indications			
				RUN	In 1	In 2	Out
Factory setting	Position 1	0 sec	Ready for application 1	-	-	-	-
Switch operating voltage on	Position 1		Without connected sensors!	Lights up	-	-	-
	Turn to position C		Application 1 is deleted	Lights up	Flashes	Flashes	Flashes
Setting cycle active			Application 1 is deleted	-	-	-	-
			No valid application stored	Flashes	-	-	-
<b>SRB-E ready for new applications</b>							
Select drop-out delay		Set desired time (0-30 sec.)		Flashes	-	-	-
Select application	Select desired application (1-11). (Time window for setting procedure approx. 3 sec.)		New application will be loaded	Lights up	-	-	-
Setting cycle active				Lights up	Lights up	-	-
				Lights up	Lights up	Lights up	-
				Lights up	Lights up	Lights up	Lights up
Ready for operation	The desired application is configured		Adopt new application	Lights up	-	-	-

Switch off operating voltage and connect wires according to selected application -> SRB-E... ready for operation

### 6. Diagnostic

#### 6.1 LED indications

LED	Function	Display type
RUN	Ready for operation	Continuously lit
	Not a valid application	Flashes
In 1	Input S12 closed	Continuously lit
	Time window for synchronicity exceeded	Flashes quickly
	Second channel, input S22 has not opened	Flashes slowly
In 2	Input S22 closed	Continuously lit
	Time window for synchronicity exceeded	Flashes quickly
	Second channel, input S12 has not opened	Flashes slowly
Out 1	Safety output STOP 0 ON	Continuously lit
	No release signal on input X7	Flashes quickly
	Safety outputs waiting for start (input X2)	Flashes slowly
	Feedback circuit not closed (input X3)	Flashes slowly
Out 2	Safety output STOP 1 ON	Continuously lit
	No release signal on input X7	Flashes quickly
	Safety outputs waiting for start (input X2)	Flashes slowly
	Feedback circuit not closed (input X3)	Flashes slowly

Single flashing of all LEDs with mains on

#### 6.2 Faults

Malfunctions and fault causes are displayed with the ERR-LEDs via short and long flashing signals

LED	Error cause	Long flash	Short flash	
ERR	Operating voltage too low	1	1	
	Operating voltage too high	1	2	
	Invalid rotary switch setting	1	3	
	External voltage on output Qt1	1	5, 7, 9	
	External voltage on output Qt2	1	6, 8	
		2	1	
	Termination to GND on output Qt1	2	2	
	Termination to GND on output Qt2	2	3	
	Cross-wire between inputs S12 and S22	2	4	
	<b>Undefined level on outputs:</b>			
	X2		3	4
	X3		3	5
	X7		3	9
	S12		2	9
S22		3	1	
Rotary switch > 30 sec. to position C		6	8	
Application changed and activation of operating voltage		LEDs flash quickly: RUN, In 1, In 2, Out		
Application was changed during active operation		LEDs flash quickly: ERR, In 1, In 2, Out		

Other fault codes:

Consult technical sales dept. at Schmersal

### 7. Wiring examples

#### 7.1 Possible applications

**All applications for 1 or 2-channel safe evaluation for protective equipment as follows:**

- Safety door monitoring to EN ISO 14119
- Position switches with positive break to EN 60947-5-1
- Safety sensors to EN 60947-5-3
- Emergency stop command devices to EN ISO 13850 and EN 60947-5-5
- Magnetic safety sensors to EN 60947-5-3
- Safety light curtain and photoelectric barriers according to EN 61496
- Two-hand control panels to EN ISO 13851 type IIIA and IIIC



The connection of magnetic safety switches to the SRB-E... safety relay module is only admitted when the requirements of the standard EN 60947-5-3 are observed.

As the technical data are regarded, the following minimum requirements must be met:

- Switching capacity: min. 240 mW
- Switching voltage: min. 24 VDC
- Switching current: min. 10 mA



For example, the following safety sensors meet the requirements:

- BNS 36-02Z(G), BNS 36-02/01Z(G)
- BNS 260-02Z(G), BNS 260-02/01Z(G)



When sensors with LED are wired in the control circuit (protective circuit), the following rated operating voltage must be observed and respected:

- 24 VDC with a max. tolerance of  $-5%/+20\%$

Otherwise availability problems could occur, especially in series-wired sensors, where a voltage drop in the control circuit is triggered by LED's for instance.



7.2 Application example

Dual-channel control, shown for a guard door monitor with two position switches where one has a positive break contact; with external reset button (R)

- Performance level: two-channel actuation, suitable for increasing capacity or number of contacts by means of contactor or relay with positive action contacts
- (R) = Feedback circuit



Signalling outputs must not be used in safety circuits.

Wiring example SRB-E-212ST

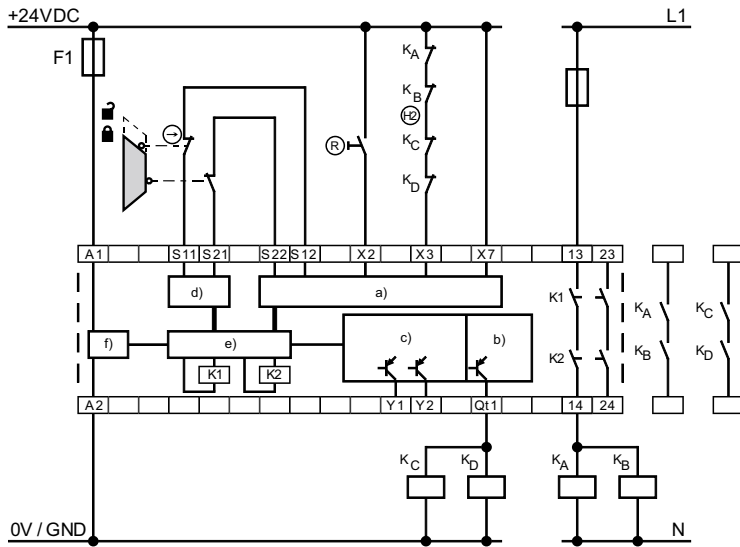

Wiring example SRB-E-322ST

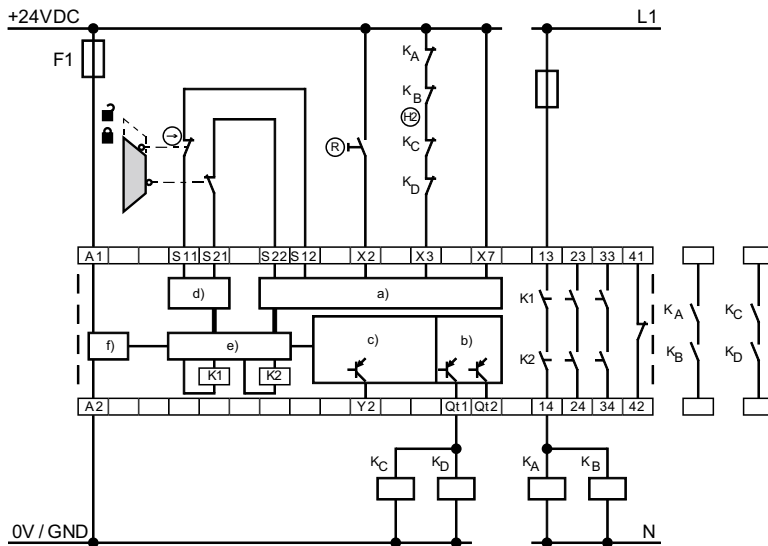

- Key**
- a) Safety inputs
  - b) Safety outputs
  - c) Signalling outputs
  - d) Clock outputs
  - e) Processing
  - f) Power



### 7.3 Start configuration

#### 7.3.1 Monitored start

- Manual start or activation of the safety relay module occurs when the button is released.



Monitoring of max. actuation time 0.03 sec. ... 3 sec.  
If the time is exceeded, the safety relay module cannot be started!

#### 7.3.2 Reset without monitoring / autostart

- The manual start or the activation of the safety relay module occurs when the button is pressed (not when it is released!).
- With autostart, X2 must be bridged to S11, S21 or +24 VDC



Not admitted without additional measure due to the risk of gaining access by stepping behind!



Within the meaning of EN 60204-1 paragraph 9.2.3.4.2, the operating mode "automatic start" is only restrictedly admissible. In particular, any inadvertent restart of the machine must be prevented by other suitable measures.

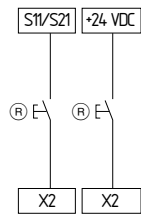

Reset button (detection of the trailing edge)	Reset without monitoring / autostart
Rotary knob position 1	Rotary knob position 6
Rotary knob position 2	Rotary knob position 7
Rotary knob position 3	Rotary knob position 8
Rotary knob position 4	Rotary knob position 9
Rotary knob position 5	Rotary knob position 10

#### 7.4 Feedback circuit / Release signal

- Suitable for increase in capacity or number of contacts by means of contactors or relays with positive-guided contacts. If the feedback circuit is not required, establish a bridge.

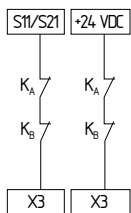

- The safety contacts and outputs can be switched during operation via the safety input X7 with the guard system closed.
- The safety outputs Qt1 and Qt2 are not switched off until the set delay time has elapsed.
- For safety-orientated use, a fault in the wiring (short circuit to 24 V potential) must be able to be excluded!
- If no deactivation during operation is required, this input must be switched to + 24 VDC.

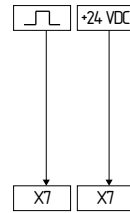

= control signal



This function is not available with rotary knob positions 11 and 12.

### 7.5 Sensor configuration

#### Single channel signal processing

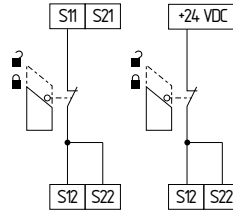

Rotary knob position	Function
4	Reset button (detection of the trailing edge)
10	Reset without monitoring / autostart

#### Dual channel signal processing NC / NC

##### With cross-wire monitoring

(Category 4 – PL e to EN ISO 13849-1 possible)

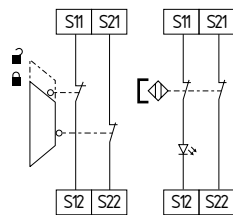

Rotary knob Position	Cross-wire monitoring	Synchronisation
1	Yes	Yes
2	Yes	No
7	Yes	Yes
8	Yes	No

##### Without cross-wire monitoring

(Cat. 4 - PL e to EN ISO 13849-1 only possible with protective wiring)

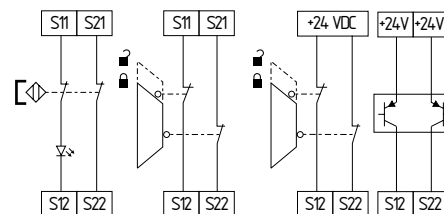

Rotary knob position	Cross-wire monitoring	Synchronisation
3	No	Yes
4	No	No
9	No	Yes
10	No	No

**Dual channel signal processing NC / NO**  
(Category 4 – PL e to EN ISO 13849-1 possible)

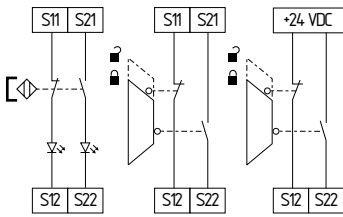

Rotary knob position	Function
5	Reset button (detection of the trailing edge)
6	Reset without monitoring / autostart

**Two-hand switch type IIIC as per EN ISO 13851**  
**(only with SRB-E-212ST)**

- Malfunctions of every contact as well as earth leakages and cross-wire shorts are detected.
- The feedback circuit (HE) is integrated as shown. The safety-technical function of external positive-guided contactors is monitored by a series-wiring of the NC contacts with the input X7. In idle state, this circuit must be closed.
- If the feedback circuit is not required, establish a bridge.

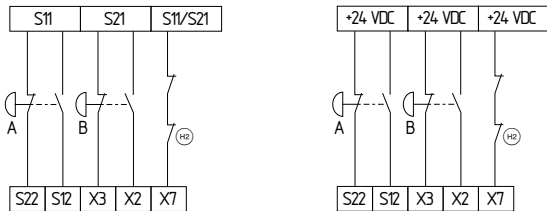

Rotary knob position	Function
11	Function two-hand control type IIIC

**Two-hand switch type IIIA as per EN ISO 13851**  
**(only with SRB-E-212ST)**

- Malfunctions in the button contact as well as short circuit to earth are detected.
- The feedback circuit (HE) is integrated as shown. The safety-technical function of external positive-guided contactors is monitored by a series-wiring of the NC contacts with the input X7. In idle state, this circuit must be closed.
- If the feedback circuit is not required, establish a bridge.

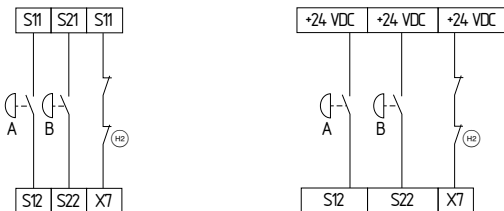

Rotary knob position	Function
12	Two-hand function type IIIA



Only the operator is protected by the two-hand switching circuit.

**8. Set-up and maintenance**

**8.1 Commissioning**

The safety relay module features degree of protection IP54 for installation in a switch cabinet.

The safety relay module is delivered ready for operation.

**Application 1 is preset in the factory.**

**8.2 Functional testing**

The safety function of the safety relay module must be tested. The following conditions must be previously checked and met:

1. Correct fixing
2. Check the integrity of the cable entry and connections
3. Check the safety relay module's enclosure for damage
4. Check the electrical function of the connected sensor technology and their influence on the safety relay module and the downstream actuators

The safety relay module features self-test functions.

If a fault is detected, the system adopts a safe mode and leads, if necessary, to undelayed deactivation of all safety outputs.

**8.3 Behaviour in the case of faults**

In the event of a fault the following procedure is recommended:

1. Identify faults according to flash codes from chapter 6.2.
  2. Rectify the fault if it is described in the table.
  3. Switch operating voltage off and on and erase fault mode.
- If fault could not be rectified, please contact the manufacturer.

**8.4 Setting report**

This report regarding the setting of the device must be completed accordingly by the customer and enclosed in the technical documentation of the machine.

The setting report must be available whenever a safety check is performed.

Company: \_\_\_\_\_

The safety-relay module is used in the following machine:

Machine n° \_\_\_\_\_ Machine type \_\_\_\_\_ Module n° \_\_\_\_\_

Configured application (mode): \_\_\_\_\_

Set drop-out delay (t): \_\_\_\_\_

Set on (date) \_\_\_\_\_ Signature of the responsible person \_\_\_\_\_

### 8.5 Maintenance

A regular visual inspection and functional test, including the following steps, is recommended:

1. Check the correct fixing of the safety relay module
2. Check the cable for damages
3. Check electrical function



If a manual functional check is necessary to detect a possible accumulation of faults, then this must take place during the intervals noted as follows:

- at least every month for PL e with category 3 or category 4 (according to EN ISO 13849-1) or SIL 3 with HFT (hardware fault tolerance) = 1 (according to EN 62061);
- at least every 12 months for PL d with category 3 (according to EN ISO 13849-1) or SIL 2 with HFT (hardware fault tolerance) = 1 (according to EN 62061).

**Damaged or defective components must be replaced.**

## 9. Disassembly and disposal

### 9.1 Disassembly

The safety relay module must be disassembled in a de-energised condition only.

### 9.2 Disposal

The safety relay module must be disposed of in an appropriate manner in accordance with the national prescriptions and legislations.

## 10. Appendix

### 10.1 Wiring/circuit information

#### Wiring example for cascading via safety input X7:

Safety outputs of following SRB-E safety relay modules can be switched off in each case via input X7.

For safety-orientated application, a fault in the wiring (short circuit to 24 V potential) must be able to be excluded!

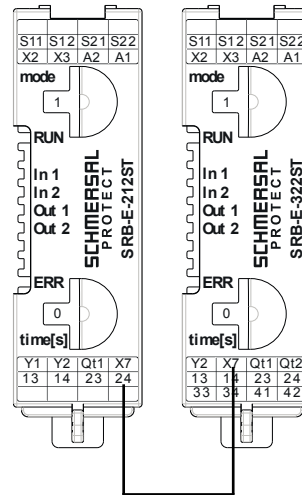

#### Air clearances and creepage distances of the safety contacts:

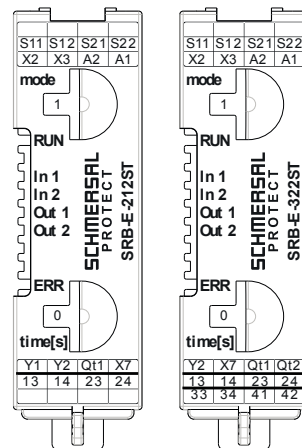

Against all other connection terminals, the safety contacts 13-14 and 23-24 comply without additional measures with the requirements for double insulation in accordance with EN 60664-1 and are to be used with switch voltages > 50 V. The safety contacts 33-34 comply with the requirements for basic insulation.

11. EU Declaration of conformity

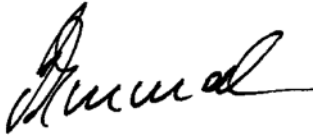
<b>EU Declaration of conformity</b>		
Original	K.A. Schmersal GmbH & Co. KG Möddinghofe 30 42279 Wuppertal Germany Internet: www.schmersal.com	
We hereby certify that the hereafter described components both in their basic design and construction conform to the applicable European Directives.		
<b>Name of the component:</b>	SRB-E-212ST SRB-E-322ST	
<b>Type:</b>	See ordering code	
<b>Description of the component:</b>	Relay safety combination for emergency stop circuits, guard door monitoring, two-hand control devices, magnetic safety switches and AOPDs	
<b>Relevant Directives:</b>	Machinery Directive	2006/42/EC
	EMC-Directive	2014/30/EU
	RoHS-Directive	2011/65/EU
<b>Applied standards:</b>	EN ISO 13851:2019 EN ISO 13849-1:2015 EN ISO 13849-2:2012 IEC 61508 parts 1-7:2010 EN 62061:2005 + Cor.:2010 + A1:2013 + A2:2015	
<b>Notified body, which approved the full quality assurance system, referred to in Appendix X, 2006/42/EC:</b>	TÜV Rheinland Industrie Service GmbH Am Grauen Stein, 51105 Köln ID n°: 0035	
<b>Person authorised for the compilation of the technical documentation:</b>	Oliver Wacker Möddinghofe 30 42279 Wuppertal	
<b>Place and date of issue:</b>	Wuppertal, March 14, 2023	
SRB-E-212ST / SRB-E-322ST-F-EN		
	Authorised signature <b>Philip Schmersal</b> Managing Director	



The currently valid declaration of conformity can be downloaded from the internet at [products.schmersal.com](http://products.schmersal.com).

