

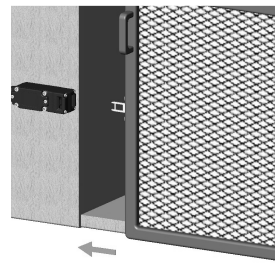

Safety Interlock Switch

KM-SS Operating Instructions

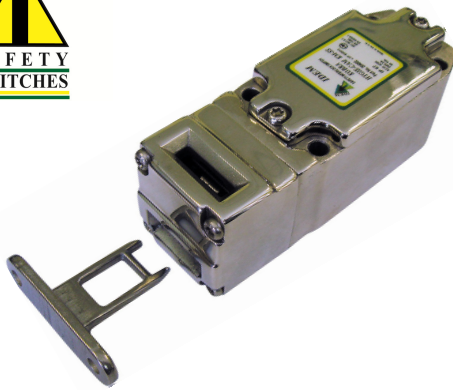

Sliding Guard

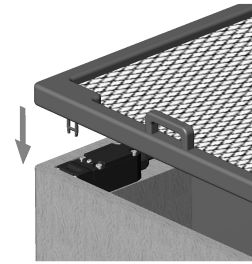

Lift off Guard

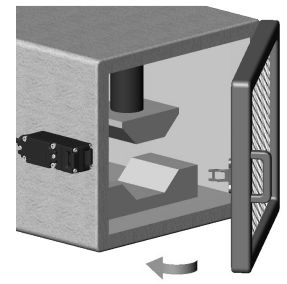

Hinged Guard

IMPORTANT NOTE:

Read and understand these instructions before installing, operating, or maintaining this equipment.

The product is designed to be a component of a customised safety orientated control system. It is the responsibility of the user to ensure the correct overall functionality of its systems and machines. IDEM, its subsidiaries and affiliates, are not in a position to guarantee all of the characteristics of a given system or product not designed by IDEM.

Application/Operation:

Tongue operated Safety Interlock Switches are designed to fit to the leading edge of sliding, hinged or lift off machine guards to provide positively operated switching contacts and provide a tamper resistant actuator mechanism. They are designed to provide robust position interlock detection for moving guards.

The switch is rigidly mounted to the frame of the guard or machine. The actuator is fitted to the moving part (frame) of the guard and is aligned to the switch entry aperture. The actuator profile is designed to match a cam mechanism within the switch head and provides a positively operated not easily defeatable interlock switch. When the actuator is inserted into the switch the safety contacts close and allow the machine start circuit to be enabled. When the actuator is withdrawn the safety contacts are positively opened and the machine circuit is broken.

Installation:

- Installation of all IDEM interlock switches must be in accordance with a risk assessment for the individual application. Installation must only be carried out by competent personnel and in accordance with these instructions.
- M5 mounting bolts must be used to fix the switch and actuator, the tightening torque to ensure reliable fixing is 4.0 Nm. Tightening torque for the lid screws, conduit entry plugs and cable glands must be 1.0 Nm to ensure IP seal. Only use the correct size gland for the conduit entry and cable outside diameter. Tightening torque for the connection terminal screws is 0.8 Nm, recommended conductor size is 1.5 – 2.5sq.mm.
- Always fit a mechanical stop to the guard to prevent damage to the front of the switch. The switch head position can be rotated by opening the lid and then pulling the end cover away from the switch and then rotating to the position required. Set the actuator gap to 3mm when the guard is closed and against the stop. (See Fig. A.) Use alignment guides to ensure that the actuator enters the switch without interfering with the sides of the aperture. Always fit the aperture plug to the unused entry aperture to prevent foreign debris entering the switch mechanism.
- After installation check operation of all control circuits ensuring that when the actuator is out of the switch, the machine cannot be started.

Stop

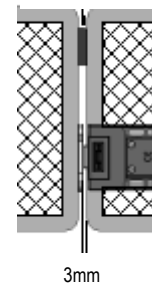
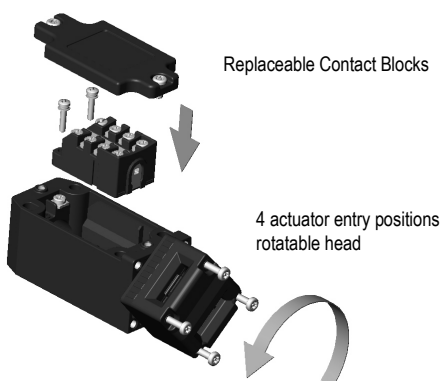

Fig. A



Replaceable Contact Blocks

4 actuator entry positions rotatable head

All NC contacts are positively operated at withdrawal of actuator



Contact operation at withdrawal of actuator

2NC 1NO	6.8	6.0	0 mm	3NC 1NO	6.8	6.0	0 mm
11/12	Open			11/12	Open		
21/22	Open			21/22	Open		
33/34			Open	31/32	Open		
				43/44			Open

4NC	6.0	0 mm	2NC 2NO	6.8	6.0	0 mm
11/12	Open		11/12	Open		
21/22	Open		21/22	Open		
31/32	Open		33/34			Open
41/42	Open		43/44			Open

IMPORTANT

The Risk Assessment for the particular application should include the risk of spare actuators. Spare actuators should not be readily available and must be securely controlled. Application consideration must be given to the fixing of the actuator which has to be in a way that prevents disassembly by easy means. The safety functions and mechanics must be tested regularly. For applications where infrequent guard access is foreseeable, the system must have a manual function test to detect a possible accumulation of faults. At least once per month for PLe Cat3/4 or once per year for PLd Cat3 (ISO13849-1). Where possible it is recommended that the control system of the machine demands and monitors these tests, and stops or prevents the machine from starting if the test is not done. (See ISO14119).

Maintenance:

- Every month: Check the switch actuator and body for signs of mechanical damage and wear. Replace any switch showing damage.
- Every 6 Months: Check for mechanical damage to switch body or actuator. Isolate power and remove cover. Check screw terminal tightness and check for signs of moisture ingress. Never attempt to repair any switch. Replace any switch displaying damage. **These requirements form part of the product warranty.**

QC Quick Connect Versions

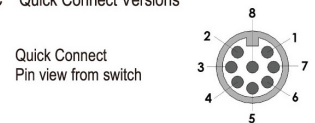
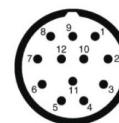

Quick Connect (QC) M23 12 Way Male (connector Length 26mm) Pin view from switch	Switch Circuit	Quick Connect (QC) M12 8 Way Male (on Flying Lead 250mm) Pin view from switch
1 3	11 / 12	1 7
4 6	21 / 22	6 5
7 8	33 / 34 or 31 / 32	4 3
9 10	41 / 42 or 43 / 44	
12	Earth	8

Safety Interlock Switch

Application Example: Door Interlock - Dual Channel non-monitored.

The switch contacts 11-12 and 21-22 from each switch are wired in series to an SCR-31-i Safety Relay to monitor for wiring short circuits. This provides Dual Channel monitoring and a check of the contactor feedback circuits through the auxiliary contacts (A) of K1 and K2.
The SCR-31-i monitors the switches and the contactors K1 and K2 and provides its own self-monitoring via force guided internal relays.

System is shown with machine stopped, guards closed and the contactors able to be energized. (E Stop switch is optional).

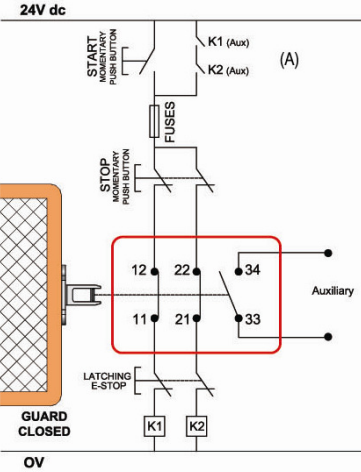
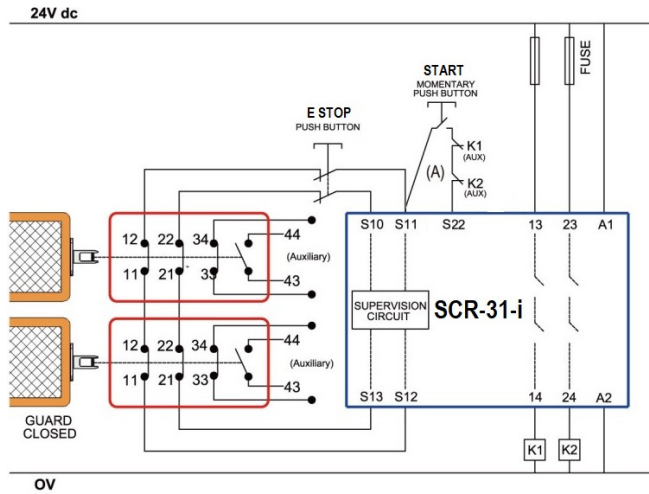

Application Example: Door Interlocks - Dual Channel monitored

The switch contacts 11-12 and 21-22 from each switch are wired in series to an SCR-3 Safety Relay to monitor for wiring short circuits. This provides Dual Channel monitoring and a check of the contactor feedback circuits through the auxiliary contacts (A) of K1 and K2.
The SCR-3 monitors the switch and the contactors K1 and K2 and provides its own self-monitoring via force guided internal relays.

System is shown with machine stopped, guards closed and the contactors able to be energized.

Standards: ISO14119, IEC60947-5-1, EN60204-1
ISO 13849-1, UL60947-5-1.

Safety Classification & Reliability Data:

Mechanical Reliability B10d
ISO 13849-1
EN62061
Safety Data – Annual Usage

2.5 x 10⁶ operations at 100mA load
Up to PLe depending upon system architecture
Up to SIL3 depending upon system architecture
8 cycles per hour/24 hours per day/365 days
MTTFd 356 years

Utilization Category AC15 A300 240V. 3A Pilot Duty
Overload protection fuse (fuse externally) 10A. (FF).
Thermal Current (Ith) 10A
Rated Insulation/Withstand Voltages 600VAC/2500VAC
Actuator Travel/Force for Positive Opening 6mm/12N
Actuator Entry Minimum Radius 175mm Standard 100mm Flexible
Maximum Approach Withdrawal Speed 600mm/s
Body Material Stainless Steel 316
Enclosure Protection IP67 IP69K
Operating Temperature -25C +80C
Vibration IEC 68-2-6 10-55Hz+1Hz
Excursion: 0.35mm, 1 octave/min
Conduit Entry Various (see sales part numbers)
Fixing 2 x M4

Information with regard to UL Standards:

Type 1 Enclosures.
Use 16 - 12AWG stranded copper insulated conductors rated 90°C minimum. (75C. ampacity).
Terminal tightening torque 7lbs ins (0.8Nm).
Intended for same polarity use and one polymeric conduit connection.
Not suitable for connection to a rigid metal conduit system.
Electrical Rating: Pilot Duty A300 240V.ac 3A. 6,000 cycles.
Maximum ambient temperature 80°C.
(Earth bonding terminal inside enclosure if required – use 16-12AWG conductors).



WARNING: DO NOT DEFEAT, TAMPER, OR BYPASS THE SAFETY FUNCTION. FAILURE TO DO SO CAN RESULT IN DEATH OR SERIOUS INJURY.

AVERTISSEMENT: NE PAS DESACTIVER, MODIFIER, RETIRER, OU CONTOURNER CETI INTERVERROUILLAGE IL PEUT EN RESULTER DES BLESSURES GRAVES DU PERSONNEL UTILISATEUR.

Original Instructions.

To request this data sheet in other languages please contact info@idemsafety.com
Um dieses Datenblatt in Deutscher Sprache wenden Sie sich bitte anfordern info@idemsafety.com
Pour obtenir cette fiche en Français, veuillez contacter info@idemsafety.com
Para solicitar esta hoja de datos en Español, por favor contacto con info@idemsafety.com

