

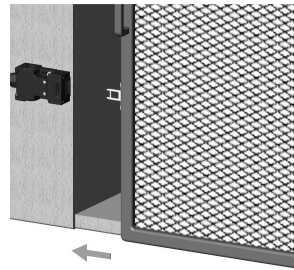

# Safety Interlock Switch

## K-SS Operating Instructions

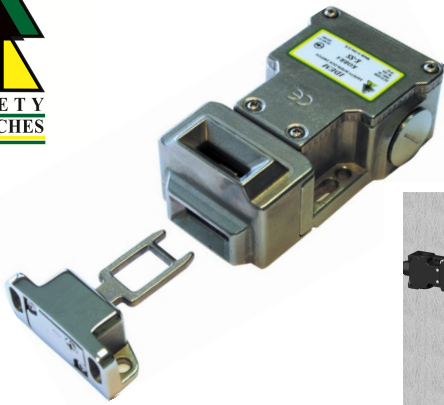

Sliding Guard

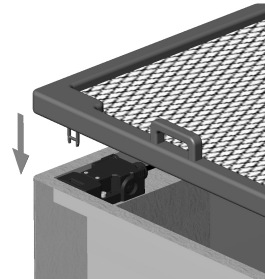

Lift off Guard

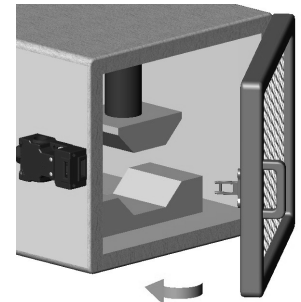

Hinged Guard

### IMPORTANT NOTE:

#### Read and understand these instructions before installing, operating, or maintaining this equipment.

The product is designed to be a component of a customised safety orientated control system. It is the responsibility of the user to ensure the correct overall functionality of its systems and machines. IDEM, its subsidiaries and affiliates, are not in a position to guarantee all of the characteristics of a given system or product not designed by IDEM.

#### Application:

K-SS Tongue Interlock Switches are designed to be mounted for interlock position sensing of hinged moving guards. They can be fitted to the leading edge of sliding, hinged or lift off guards.

They have positive opening contacts in accordance with IEC 60947-5-1 and the switch design offers a tamper resistant actuator key. They are available with actuator types to cover most fixing positions and contact blocks are available in slow make/break 2NC 1NO, 2NC 2NO, 3NC 1NO, or 4NC. Enclosures are protected to IP67 and IP69K.

#### Operation:

Operation of the switches is achieved by withdrawing the actuator key from the switch to cause deflection of the switch plunger. Positive actuation of the contacts is achieved at 6mm withdrawal of the actuator.

#### Installation:

- Installation of all IDEM interlock switches must be in accordance with a risk assessment for the individual application. Installation must only be carried out by competent personnel and in accordance with these instructions.
- M5 mounting bolts must be used to fix the switch and actuator, the tightening torque to ensure reliable fixing is 4.0 Nm. Tightening torque for the lid screws, conduit entry plugs and cable glands must be 1.0 Nm to ensure IP seal. Only use the correct size gland for the conduit entry and cable outside diameter. Tightening torque for the connection terminal screws is 0.8 Nm, recommended conductor size is 1.5 – 2.5sq.mm.
- Always fit a mechanical stop to the guard to prevent damage to the front of the switch. The switch head position can be rotated by opening the lid and then pulling the end cover away from the switch and then rotating to the required position. Set the actuator gap to 3mm when the guard is closed and against the stop. (See Fig. A.) Use alignment guides to ensure that the actuator enters the switch without interfering with the sides of the aperture. Always fit the aperture plug to the unused entry aperture to prevent foreign debris entering the switch mechanism.
- After installation check operation of all control circuits ensuring that when the actuator is out of the switch the machine cannot be started.

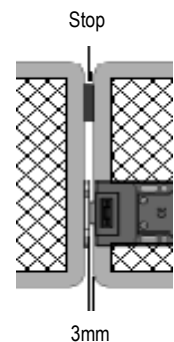
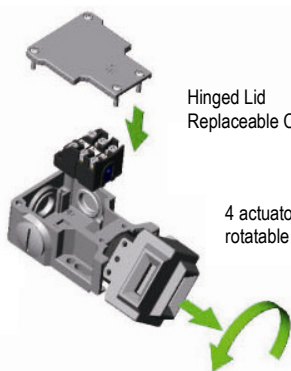

Fig. A

### IMPORTANT

The Risk Assessment for the particular application should include the risk of spare actuators. Spare actuators should not be readily available and must be securely controlled. Application consideration must be given to the fixing of the actuator which has to be in a way that prevents disassembly by easy means. The safety functions and mechanics must be tested regularly. For applications where infrequent guard access is foreseeable, the system must have a manual function test to detect a possible accumulation of faults. At least once per month for PLe Cat3/4 or once per year for PLd Cat3 (ISO13849-1). Where possible it is recommended that the control system of the machine demands and monitors these tests, and stops or prevents the machine from starting if the test is not done. (See ISO14119).



Hinged Lid  
Replaceable Contact Blocks

4 actuator entry positions  
rotatable head

All NC contacts are positively operated at withdrawal of actuator

#### Contact operation at withdrawal of actuator

2NC 1NO			6.8 6.0 0 mm			3NC 1NO			6.8 6.0 0 mm		
11/12	Open		11/12	Open		11/12	Open		11/12	Open	
21/22	Open		21/22	Open		21/22	Open		21/22	Open	
33/34		Open	31/32	Open		31/32	Open		33/34		Open
			43/44		Open	43/44		Open			

4NC			6.0 0 mm			2NC 2NO			6.8 6.0 0 mm		
11/12	Open		11/12	Open		11/12	Open		11/12	Open	
21/22	Open		21/22	Open		21/22	Open		21/22	Open	
31/32	Open		31/32	Open		33/34		Open	33/34		Open
41/42	Open		41/42	Open		43/44		Open	43/44		Open

Every Month: Check the switch actuator and body for signs of mechanical damage and wear. Replace any switch showing damage.

Every 6 Months: Check for mechanical damage to switch body or actuator. Replace any switch showing damage. Isolate power and remove cover. Check screw terminal tightness and check for signs of moisture ingress. Never attempt to repair any switch.

**These requirements form part of the product warranty.**

Quick Connect (QC) M23 12 Way Male (connector length 26mm) Pin view from Switch	Switch Circuit	Quick Connect (QC) M12 8 Way Male (on Flying Lead 250mm) Pin view from Switch
1 3	11 / 12	1 7
4 6	21 / 22	6 5
7 8	33/34 or 31/32	4 3
9 10	41/42 or 43/44	
12	Earth	8

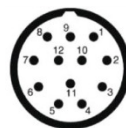

Quick Connect  
Pin View from Switch

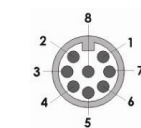

# Safety Interlock Switch

## Application Example: Door Interlocks - Dual Channel monitored

The switch contacts 11-12 and 21-22 from each switch are wired in series to an SCR-31-i Safety Relay to monitor for wiring short circuits. This provides Dual Channel monitoring and a check of the contactor feedback circuits through the auxiliary contacts (A) of K1 and K2.

The SCR-31-i monitors the switches and the contactors K1 and K2 and provides its own self-monitoring via force guided internal relays.

System is shown with machine stopped, guards closed and the contactors able to be energized. (E Stop switch is optional).

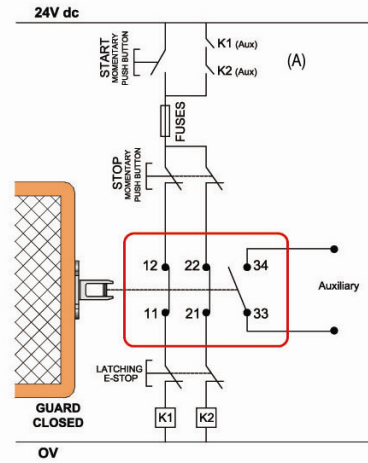
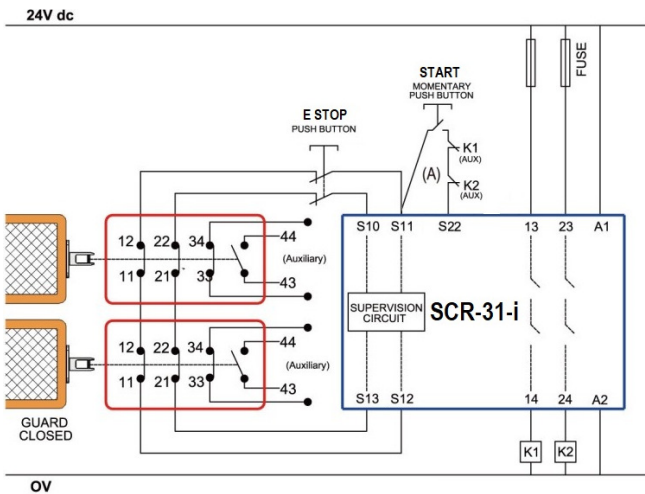

## Application Example: Door Interlock - Dual Channel non-monitored

This system shows interlock switch circuits 11-12 and 21-22 configured to allow dual circuit direct feeds to contactor coils K1 and K2.

When the start button is pressed and then released, the auxiliary contacts (A) of contactors K1 and K2 maintain the feed to the contactor coils.

Opening of the Interlock switch or depressing the E Stop will isolate power to the contactor coils. Re-start can only occur providing the Guard is closed, the E Stop is reset.

System is shown with the guards closed and the machine able to start.

<b>Standards:</b>	ISO14119, IEC60947-5-1, EN60204-1 ISO 13849-1, UL60947-5-1.
<b>Safety Classification &amp; Reliability Data:</b>	2.5 x 10 <sup>6</sup> operations at 100mA load Up to PLe depending upon system architecture Up to SIL3 depending upon system architecture 8 cycles per hour/24 hours per day/365 days MTTFd 356 years
Mechanical Reliability B10d	AC15 A300 240V. 3A Pilot Duty
ISO 13849-1	10A. (FF).
EN62061	10A
Safety Data – Annual Usage	600VAC/2500VAC
Utilization Category	6mm/12N
Overload protection fuse (fuse externally)	175mm Standard 100mm Flexible
Thermal Current (Ith)	600mm/s
Rated Insulation/Withstand Voltages	Body Material Stainless Steel 316
Actuator Travel/Force for Positive Opening	IP67 IP69K
Actuator Entry Minimum Radius	-25C +80C
Maximum Approach Withdrawal Speed	IEC 68-2-6 10-55Hz+1Hz
Body Material	Excursion: 0.35mm, 1 octave/min
Enclosure Protection	Various (see sales part numbers)
Operating Temperature	Fixing 2 x M4
Vibration	
Conduit Entry	
Fixing	

### Information with regard to UL Standards:

Type 1 Enclosures.  
Use 16 - 12AWG stranded copper insulated conductors rated 90°C minimum. (75C. ampacity).  
Terminal tightening torque 7lbs ins (0.8Nm).  
Intended for same polarity use and one polymeric conduit connection.  
Not suitable for connection to a rigid metal conduit system.  
Electrical Rating: Pilot Duty A300 240V.ac 3A. 6,000 cycles.  
Maximum ambient temperature 80°C.  
(Earth bonding terminal inside enclosure if required – use 16-12AWG conductors).

### Original Instructions.

To request this data sheet in other languages please contact [info@idemsafety.com](mailto:info@idemsafety.com)  
Um dieses Datenblatt in Deutscher Sprache wenden Sie sich bitte anfordern [info@idemsafety.com](mailto:info@idemsafety.com)  
Pour obtenir cette fiche en Français, veuillez contacter [info@idemsafety.com](mailto:info@idemsafety.com)  
Para solicitar esta hoja de datos en Español, por favor contacto con [info@idemsafety.com](mailto:info@idemsafety.com)



**WARNING: DO NOT DEFEAT, TAMPER, OR BYPASS THE SAFETY FUNCTION. FAILURE TO DO SO CAN RESULT IN DEATH OR SERIOUS INJURY.**

**AVERTISSEMENT: NE PAS DESACTIVER, MODIFIER, RETIRER, OU CONTOURNER CETI INTERVERROUILLAGE IL PEUT EN RESULTER DES BLESSURES GRAVES DU PERSONNEL UTILISATEUR.**

