

To minimize the risk of potential safety problems, you should follow all applicable local and national codes that regulate the installation and operation of your equipment. These codes vary from area to area and it is your responsibility to determine which codes should be followed, and to verify that the equipment, installation, and operation are in compliance with the latest revision of these codes.

Equipment damage or serious injury to personnel can result from the failure to follow all applicable codes and standards. We do not guarantee the products described in this publication are suitable for your particular application, nor do we assume any responsibility for your product design, installation, or operation.

If you have any questions concerning the installation or operation of this equipment, or if you need additional information, please call Technical Support at 770-844-4200.

This publication is based on information that was available at the time it was printed. At AutomationDirect.com® we constantly strive to improve our products and services, so we reserve the right to make changes to the products and/or publications at any time without notice and without any obligation. This publication may also discuss features that may not be available in certain revisions of the product.

Removable Terminal Block Specifications

| | |
|---------------------|---|
| Number of Positions | 20 screw terminals |
| Wire Range | 22-14 AWG (0.324 to 2.08 sq. mm) solid / stranded conductor 3/64 in. (1.2 mm) insulation maximum "USE COPPER CONDUCTORS, 60°C" or equivalent*. |
| Screw Driver Width | 1/4 inch (6.5 mm) maximum |
| Screw Size | M3 size |
| Screw Torque | Field terminals – 7 - 9 in./lb (.0882 - 1.02 Nm) Self-jacking screws – 2.7 - 3.6 in./lb (0.3 - 0.4 Nm). Do not overtighten screws when installing terminal block. |



P3-16DA-2 Analog Output

The P3-16DA-2 Voltage Analog Output Module provides 16 channels of $\pm 10\text{VDC}$ outputs for use with the Productivity3000 Programmable Automation Controller

- Safety Information 1
- Removable Terminal Block Specifications 1
- General Specifications 2
- Output Specifications 2
- Schematic and Wiring Diagram 3
- Module Installation Procedure 4
- Terminal Block Removal 4
- Hot Swap Information 4
- Wiring Options 5
- Module Configuration 5
- Linear Scaling 6
- Non-Linear Scaling 6
- LCD Panel Display Menus 7

Terminal Block sold separately, Terminal Block Cover included (see wiring options on page 5).

Warranty: Thirty-day money-back guarantee. Two-year limited replacement. (See www.productivitypac.com for details).

General Specifications

| | |
|-------------------------------|---|
| Operating Temperature | 0° to 60°C (32° to 140°F), |
| Storage Temperature | -20° to 70°C (-4° to 158°F) |
| Humidity | 5 to 95% (non-condensing) |
| Environmental Air | No corrosive gases permitted |
| Vibration | IEC60068-2-6 (Test Fc) |
| Shock | IEC60068-2-27 (Test Ea) |
| Field to Logic Side Isolation | 1800VAC applied for 1 second |
| Insulation Resistance | >10MΩ @ 500 VDC |
| Heat Dissipation | 6.4 W |
| Enclosure Type | Open Equipment |
| Agency Approvals | UL508 and UL 1604 (Certified for Canada and USA) CE (EN61131-2*) This equipment is suitable for use in Class I, Division 2/Zone 2, Groups A, B, C, and D or non-hazardous locations only. |
| Module Keying to Backplane | Electronic |
| Module Location | Any I/O slot in any local, expansion, or remote base in a Productivity3000 System. |
| Field Wiring | Removable terminal block (not included). Use ZIPLink Wiring System or optional terminal block. See "Wiring Options" on page 5. |
| EU Directive | See the "EU Directive" topic in the Productivity3000 Help File. Information can also be obtained at: www.productivitypac.com |
| Terminal Type (not included) | 20-position removable terminal block |
| Weight | 105g (3.73 oz) |

*Meets EMC and Safety requirements. See the D.O.C. for details.

WARNING: Explosion hazard – Substitution of components may impair suitability for Class I, Division 2.

AVERTISSEMENT: Risque d'explosion : la substitution de composants peut compromettre la convenance pour la Classe I, Zone 2 ou pour la Classe I, Division 2.

Output Specifications

| | |
|---|--|
| Output Channels | 16 |
| Module Signal Output Range | ±10VDC |
| Output Signal Resolution | 16-bit |
| Resolution Value of LSB (least significant bit) | ±10V = 305µV/count 1 LSB = 1 count |
| Data Range | -32768 to +32767 counts |
| Output type (sourcing/sinking) | Voltage: 10mA max |
| Output Value in Fault Mode | 0V |
| Output Impedance | 0.2Ω typical |
| Load Impedance | ≥ 1000Ω |
| Maximum Capacitive Load | .01µF maximum |
| Allowed Load Type | Grounded |
| Maximum Inaccuracy | 0.1% of range (including temperature drift) |
| Maximum Full Scale Calibration Error (not including offset error) | ±0.025% of range maximum |
| Maximum Offset Calibration Error | ±.025% of range maximum |
| Accuracy vs. Temperature | ±25 ppm/ °C maximum f.s. calibration change (± .0025% of range / °C) |
| Max Crosstalk | -96 dB, 1 LSB |
| Linearity Error (end to end) | ±16 LSB maximum (±0.025% of full scale) Monotonic with no missing codes |
| Output Stability and Repeatability | ±10 LSB after 10 min. warm-up (typical) |
| Output Ripple | 0.05% of full scale |
| Output Settling Time | 0.3 ms max, 5 µs min (full scale change) |
| All Channel Update Rate | 0.6 ms |
| Maximum Continuous Overload | Outputs current limited to 40mA typical Continuous overloads on multiple outputs can damage the module. |
| Type of Output Protection | 0.1µF Transient Suppressor |
| External DC Power Required | 24 VDC (-20% / + 25%), 252mA |

Voltage Output Circuits

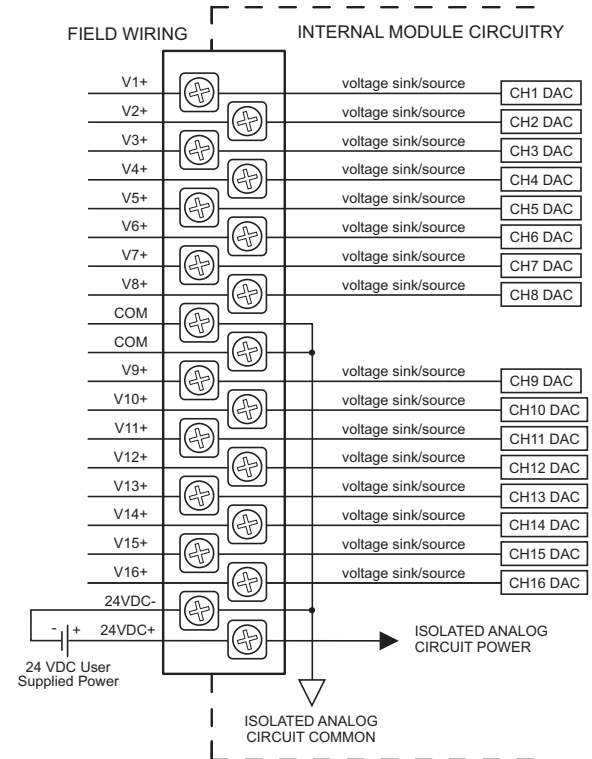
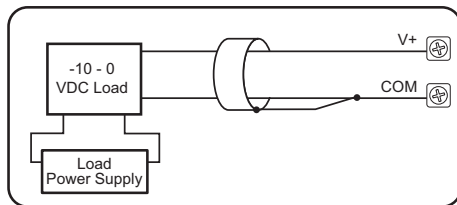
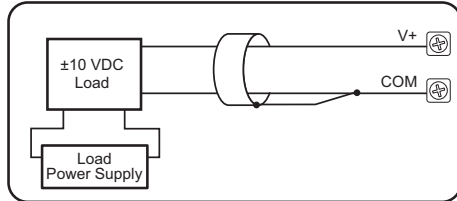
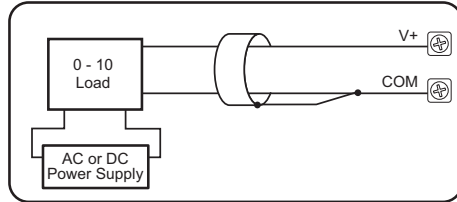

Module Installation Procedure

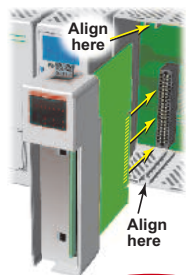

WARNING: Do not apply field power until the following steps are completed. See hot-swapping procedure for exceptions.

AVERTISSEMENT: Ne pas appliquer la puissance de champ avant l'exécution des étapes qui suivent. Consultez la procédure de remplacement à chaud pour les exceptions.

Step One: Align circuit card with slot and press firmly to seat module into connector.

Step Two: Pull top and bottom locking tabs toward module face. Click indicates lock is engaged.

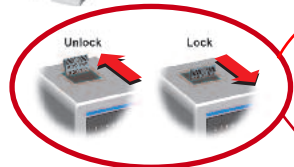

Step Three: Attach field wiring using optional terminal block or ZIPLink wiring system and install cover.

To install or remove terminal block cover, press middle to flex cover.

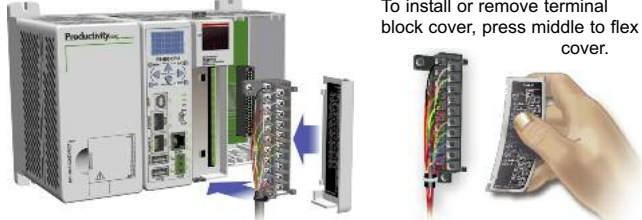

WARNING: Explosion hazard – Do not connect or disconnect connectors or operate switches while circuit is live unless the area is known to be non-hazardous. Do not hot-swap modules unless the area is known to be non-hazardous.

AVERTISSEMENT: Risque d'explosion : ne pas connecter ou déconnecter les connecteurs ni actionner les commutateurs alors que le circuit est sous tension, à moins que la zone ne soit reconnue non dangereuse. Ne pas remplacer à chaud les modules à moins que la zone ne soit reconnue non dangereuse.

Terminal Block Removal

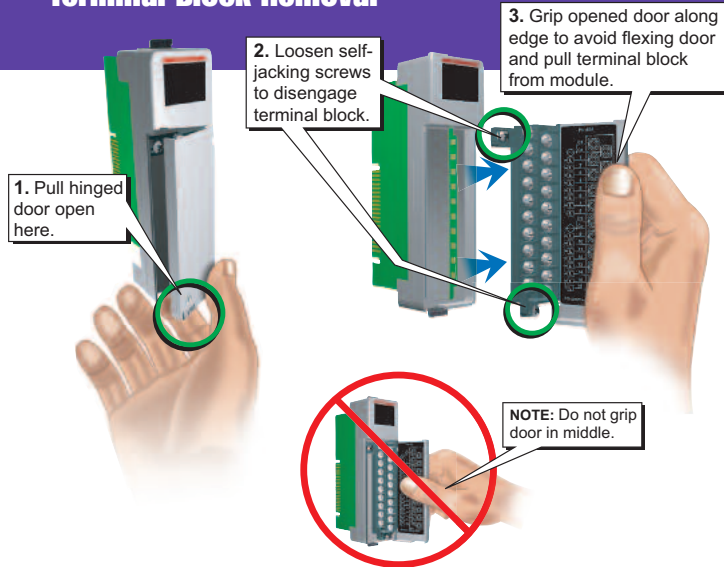

Important Hot-Swap Information

The Productivity3000 PAC supports hot-swap!

Individual modules, expansion bases, and entire remote base groups can be taken offline, removed, and replaced while the rest of the PAC system continues controlling your process. Before attempting to use the hot-swap feature, be sure to read the hot-swap topic in the programming software's help file or our online documentation at AutomationDirect.com for details on how to plan your installation for use of this powerful feature.

Wiring Options

1 ZIPLink Connection System Cable + ZIPLink Module = Complete System

ZIPLink pre-wired terminal block cables



0.5m (1.6FT) cable
1.0m (3.3FT) cable
2.0m (6.6FT) cable



ZL-P3-CBL20-L
ZL-P3-CBL20-1L
ZL-P3-CBL20-2L

ZIPLink Modules



Feed through

ZL-RTB20

2 Terminal Block with pigtail cable



0.5m (1.6FT) cable
1.0m (3.3FT) cable
2.0m (6.6FT) cable



ZL-P3-CBL20-P
ZL-P3-CBL20-1P
ZL-P3-CBL20-2P

3 Terminal Block only



P3-RTB
(Quantity 1)

Module Configuration

Using the Hardware Configuration tool in the Productivity Suite programming software, drag and drop the P3-16DA-2 module into the base configuration.

Select *Automatic Module Verification* or *No Verification and Enable Hot Swap* and *Stop Mode Values*. If desired, assign a *User Tagname* to each output point (channel) selected and to each *Status Bit Item*.

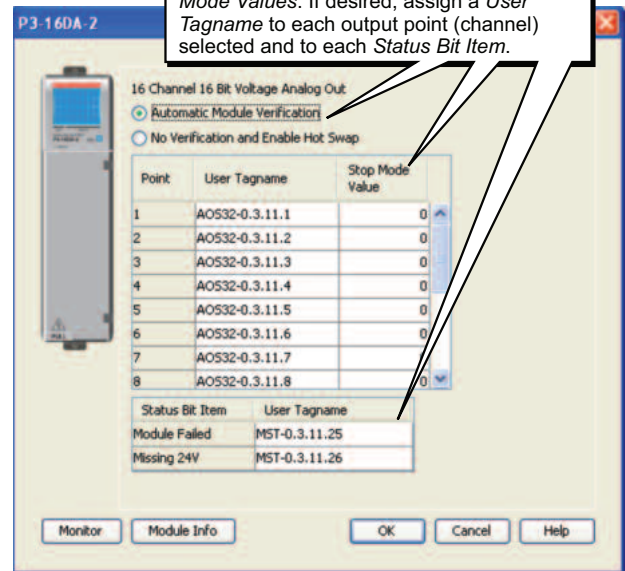

Linear Scaling

The Scale (Linear) function can be used to:

- Convert an application specific range to a range which is native to the analog output module.
- Make other linear conversions in ranges appropriate to the application.

Select the Input and Output tags appropriate for the application. Convert raw input signals to engineering units for use in the program, or convert engineering units to output signals for control purposes

| Input | Output |
|-------|--------|
| min | min |
| max | max |

Non-Linear Scaling

The Scale (Non-Linear) function can be used for Non-Linear applications.

| Input value | Desired Output |
|-------------|----------------|
| 0 | 0 |
| 1 | 0.5 |
| 2 | 1 |
| 3 | 1.55 |
| 4 | 2.25 |
| 5 | 3 |
| 6 | 4.55 |
| 6.5 | 6.75 |
| 7 | 7 |
| 0 | 0 |
| 0 | 0 |
| 0 | 0 |
| 0 | 0 |
| 0 | 0 |
| 0 | 0 |
| 0 | 0 |

Select the minimum and maximum values of the raw input signal. These values will relate to the minimum and maximum scaled values.

| Input | Output |
|-------|--------|
| min | min |
| max | max |

LCD Panel Display

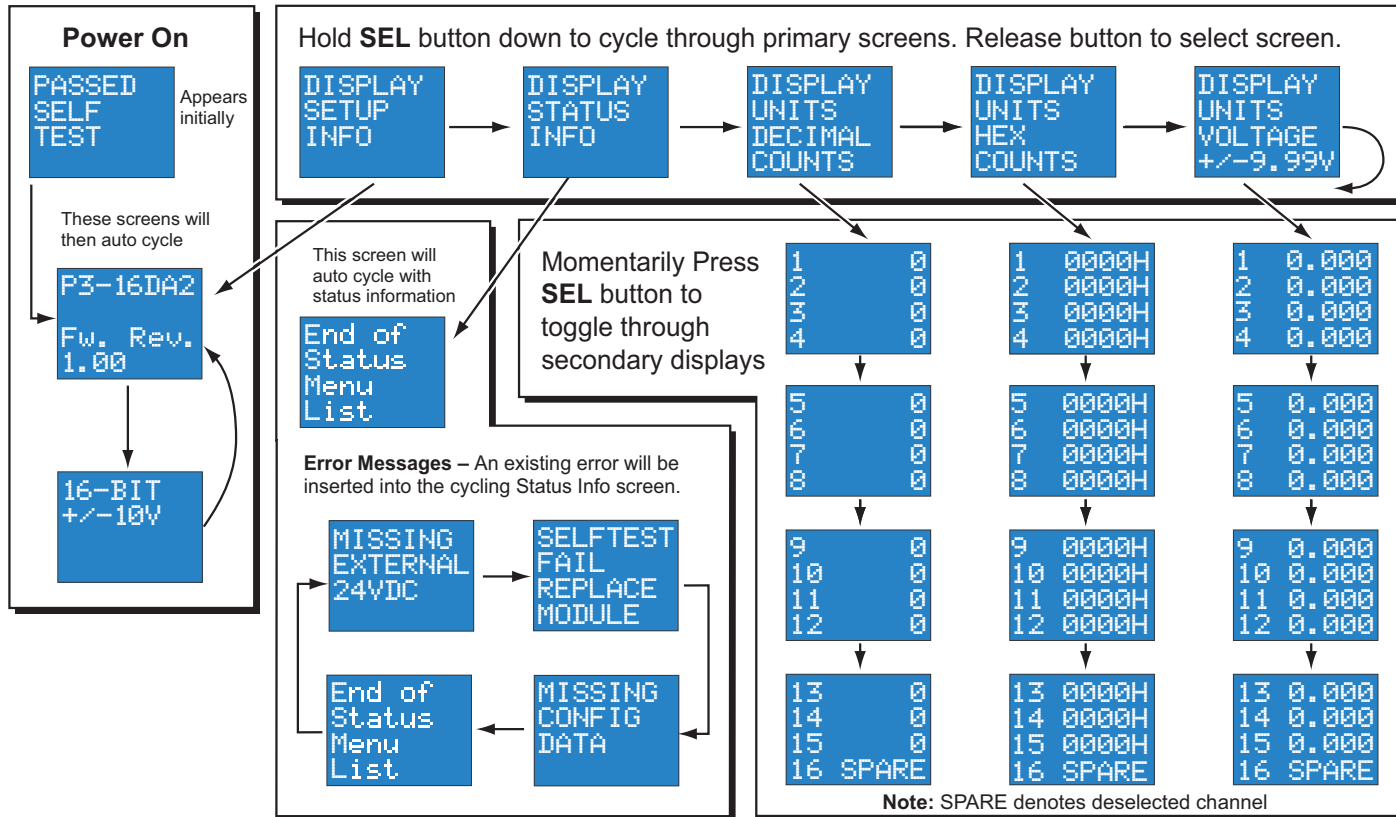

| Document Name | Edition/Revision | Date |
|---------------|------------------|------------|
| P3-16DA-2-M | 1st Ed. Rev. A | 12/20/2013 |

Copyright 2014, AutomationDirect.com Incorporated/All Rights Reserved Worldwide