

To minimize the risk of potential safety problems, you should follow all applicable local and national codes that regulate the installation and operation of your equipment. These codes vary from area to area and it is your responsibility to determine which codes should be followed, and to verify that the equipment, installation, and operation are in compliance with the latest revision of these codes.

Equipment damage or serious injury to personnel can result from the failure to follow all applicable codes and standards. We do not guarantee the products described in this publication are suitable for your particular application, nor do we assume any responsibility for your product design, installation, or operation.

If you have any questions concerning the installation or operation of this equipment, or if you need additional information, please call Technical Support at 770-844-4200.

This publication is based on information that was available at the time it was printed. At AutomationDirect.com® we constantly strive to improve our products and services, so we reserve the right to make changes to the products and/or publications at any time without notice and without any obligation. This publication may also discuss features that may not be available in certain revisions of the product.

Removable Terminal Block Specifications

Number of Positions	20 screw terminals
Wire Range	22-14 AWG (0.324 to 2.08 sq. mm) solid / stranded conductor 3/64 in. (1.2 mm) insulation maximum "USE COPPER CONDUCTORS, 60°C" or equivalent*.
Screw Driver Width	1/4 inch (6.5 mm) maximum
Screw Size	M3 size
Screw Torque	Field terminals – 7 - 9 in./lb (.0882 - 1.02 Nm) Self-jacking screws – 2.7 - 3.6 in./lb (0.3 - 0.4 Nm). Do not overtighten screws when installing terminal block.



P3-16AD-2 Analog Input

The P3-16AD-2 Voltage Analog Input Module provides 16 channels for receiving 0 to 10 VDC signals for use with the Productivity3000 Programmable Automation Controller.

Safety Information	1
Removable Terminal Block Specifications	1
General Specifications	2
Input Specifications	2
Schematic and Wiring Diagram	3
Module Installation Procedure	4
Terminal Block Removal	4
Hot Swap Information	4
Wiring Options	5
Module Configuration	5
Linear Scaling	6
Non-Linear Scaling	6
LCD Panel Display Menus	7

Terminal Block sold separately, Terminal Block Cover included (see wiring options on page 5).

Warranty: Thirty-day money-back guarantee. Two-year limited replacement. (See www.productivitypac.com for details).

General Specifications

Operating Temperature	0° to 60°C (32° to 140°F),
Storage Temperature	-20° to 70°C (-4° to 158°F)
Humidity	5 to 95% (non-condensing)
Environmental Air	No corrosive gases permitted
Vibration	IEC60068-2-6 (Test Fc)
Shock	IEC60068-2-27 (Test Ea)
Field to Logic Side Isolation	1800 VAC applied for 1 second
Insulation Resistance	>10MΩ @ 500 VDC
Heat Dissipation	1.4 W
Enclosure Type	Open Equipment
Agency Approvals	UL508 file E157382, Canada & USA UL1604 file E200031, Canada & USA CE (EN61131-2*) This equipment is suitable for use in Class 1, Division 2, Groups A, B, C and D or non-hazardous locations only.
Module Keying to Backplane	Electronic
Module Location	Any i?o slot in any local, expansion, or remote base in a Productivity3000 System.
Field Wiring	Removable terminal block (not included). Use ZIPLink Wiring System or optional terminal block. See "Wiring Options" on page 5.
EU Directive	See the "EU Directive" topic in the Productivity3000 Help File. Information can also be obtained at: www.productivitypac.com
Terminal Type (not included)	20-position removable terminal block
Weight	105g (3.73 oz)

*Meets EMC and Safety requirements. See the D.O.C. for details.

Input Specifications

Input Channels	16
Module Signal Input Range	0 - 10 VDC
Signal Resolution	16-bit
Resolution Value of LSB (least significant bit)	0 - 10 VDC = 152 μV per count (1 LSB = 1 count)
Data Range	0 to 65535 counts
Input Type	Single-ended (one common)
Maximum Continuous Overload	±100V
Input Impedance	250K Ω (typical)
Filter Characteristics	Low Pass, -3dB @ 100Hz
Sample Duration Time	7 ms per channel (does not include ladder scan time)
All Channel Update Rate	112 ms
Open Circuit Detection Time	Zero reading within 1s
Conversion Method	Successive approximation
Accuracy vs. Temperature	±25 PPM / °C Maximum
Maximum Inaccuracy	0.1% of range (including temperature drift)
Linearity Error (end to end)	±10 LSB maximum (±0.015% of range) Monotonic with no missing codes
Input Stability and Repeatability	±10 LSB
Full Scale Calibration Error (not including offset)	±10 LSB maximum (±0.015% of range)
Offset Calibration Error	±10 LSB maximum
Max Crosstalk	-76 dB, 10 LSB
External DC Power Required	24 VDC (-20% / + 25%), 41mA maximum

WARNING: Explosion hazard – Substitution of components may impair suitability for Class I, Division 2.

AVERTISSEMENT: Risque d'explosion : la substitution de composants peut compromettre la convenance pour la Classe I, Zone 2 ou pour la Classe I, Division 2.

Voltage Input Circuits

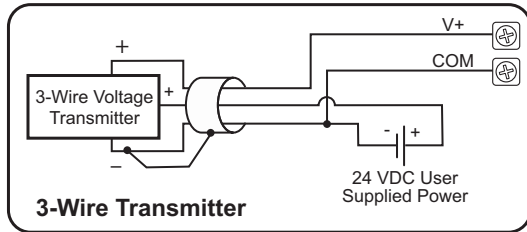
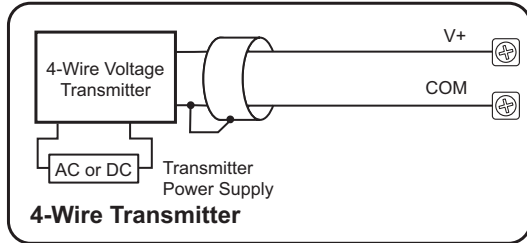

Notes for maximum accuracy:

1. Jumper unused inputs to common.

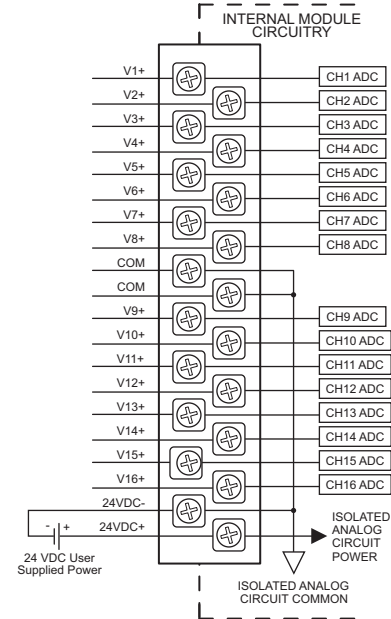

Module Installation Procedure

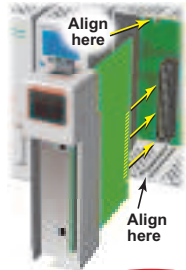

WARNING: Do not apply field power until the following steps are completed. See hot-swapping procedure for exceptions.

AVERTISSEMENT: Ne pas appliquer la puissance de champ avant l'exécution des étapes qui suivent. Consultez la procédure de remplacement à chaud pour les exceptions.

Step One: Align circuit card with slot and press firmly to seat module into connector.

Step Two: Pull top and bottom locking tabs toward module face. Click indicates lock is engaged.



Step Three: Attach field wiring using optional terminal block or ZIPLink wiring system and install cover.



To install or remove terminal block cover, press middle to flex cover.



WARNING: Explosion hazard – Do not connect or disconnect connectors or operate switches while circuit is live unless the area is known to be non-hazardous. Do not hot-swap modules unless the area is known to be non-hazardous.

AVERTISSEMENT: Risque d'explosion : ne pas connecter ou déconnecter les connecteurs ni actionner les commutateurs alors que le circuit est sous tension, à moins que la zone ne soit reconnue non dangereuse. Ne pas remplacer à chaud les modules à moins que la zone ne soit reconnue non dangereuse.

Terminal Block Removal

1. Pull hinged door open here.

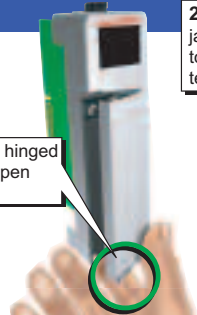

2. Loosen self-jacking screws to disengage terminal block.

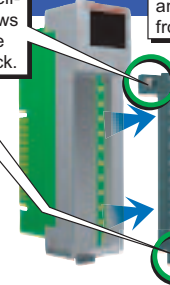

3. Grip opened door along edge to avoid flexing door and pull terminal block from module.

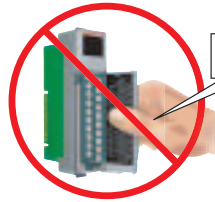
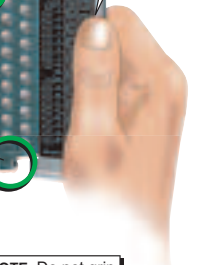

NOTE: Do not grip door in middle.

Important Hot-Swap Information

The Productivity3000 PAC supports hot-swap!

Individual modules, expansion bases, and entire remote base groups can be taken offline, removed, and replaced while the rest of the PAC system continues controlling your process. Before attempting to use the hot-swap feature, be sure to read the hot-swap topic in the programming software's help file or our online documentation at AutomationDirect.com for details on how to plan your installation for use of this powerful feature.

Wiring Options

1 ZIPLink Connection System Cable + ZIPLink Module = Complete System

ZIPLink pre-wired
terminal block cables



0.5m (1.6FT) cable
1.0m (3.3FT) cable
2.0m (6.6FT) cable

ZL-P3-CBL20-L
ZL-P3-CBL20-1L
ZL-P3-CBL20-2L



ZIPLink Modules

Feed through

ZL-RTB20

2 Terminal Block with pigtail cable



0.5m (1.6FT) cable
1.0m (3.3FT) cable
2.0m (6.6FT) cable

ZL-P3-CBL20-P
ZL-P3-CBL20-1P
ZL-P3-CBL20-2P

3 Terminal Block only

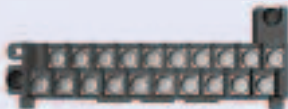

P3-RTB
(Quantity 1)

Module Configuration

Using the Hardware Configuration tool in the Productivity Suite programming software, drag and drop the P3-16AD-2 module into the base configuration.

Select *Automatic Module Verification* or *No Verification and Enable Hot Swap*. If desired, assign a *User Tagname* to each input point (channel) selected and to each *Status Bit Item*.

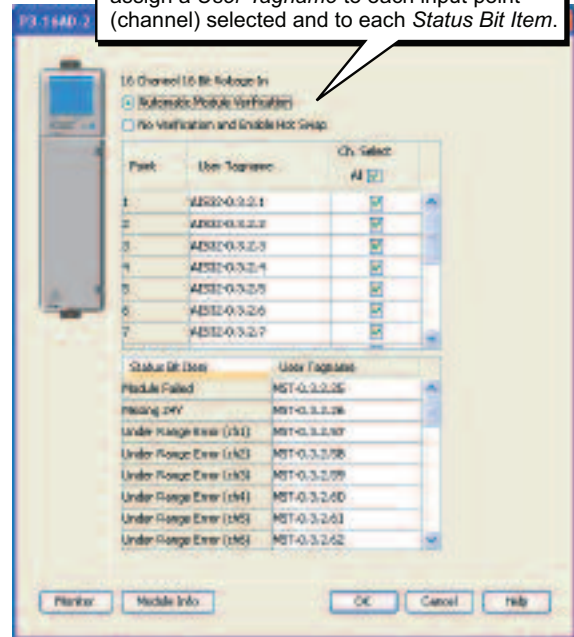

Linear Scaling

The Scale (Linear) function can be used to:

- Convert analog field input signals from the range which is native to the analog input module to an application specific range.
- Make other linear conversions in ranges appropriate to the application.

Select the Input and Output tags appropriate for the application. Convert raw input signals to engineering units for use in the program, or convert engineering units to output signals for control purposes

Input	Output
min	min
max	max

Non-Linear Scaling

The Scale (Non-Linear) function can be used for Non-Linear applications.

Input-value	Desired Output
0	0
1	1
2	1.55
3	2.25
4	3
5	4.55
6	6.75
6.5	7
7	7
0	0
0	0
0	0
0	0
0	0
0	0
0	0

Select the minimum and maximum values of the raw input signal. These values will relate to the minimum and maximum scaled values.

Input	Output
min	min
max	max

LCD Panel Display

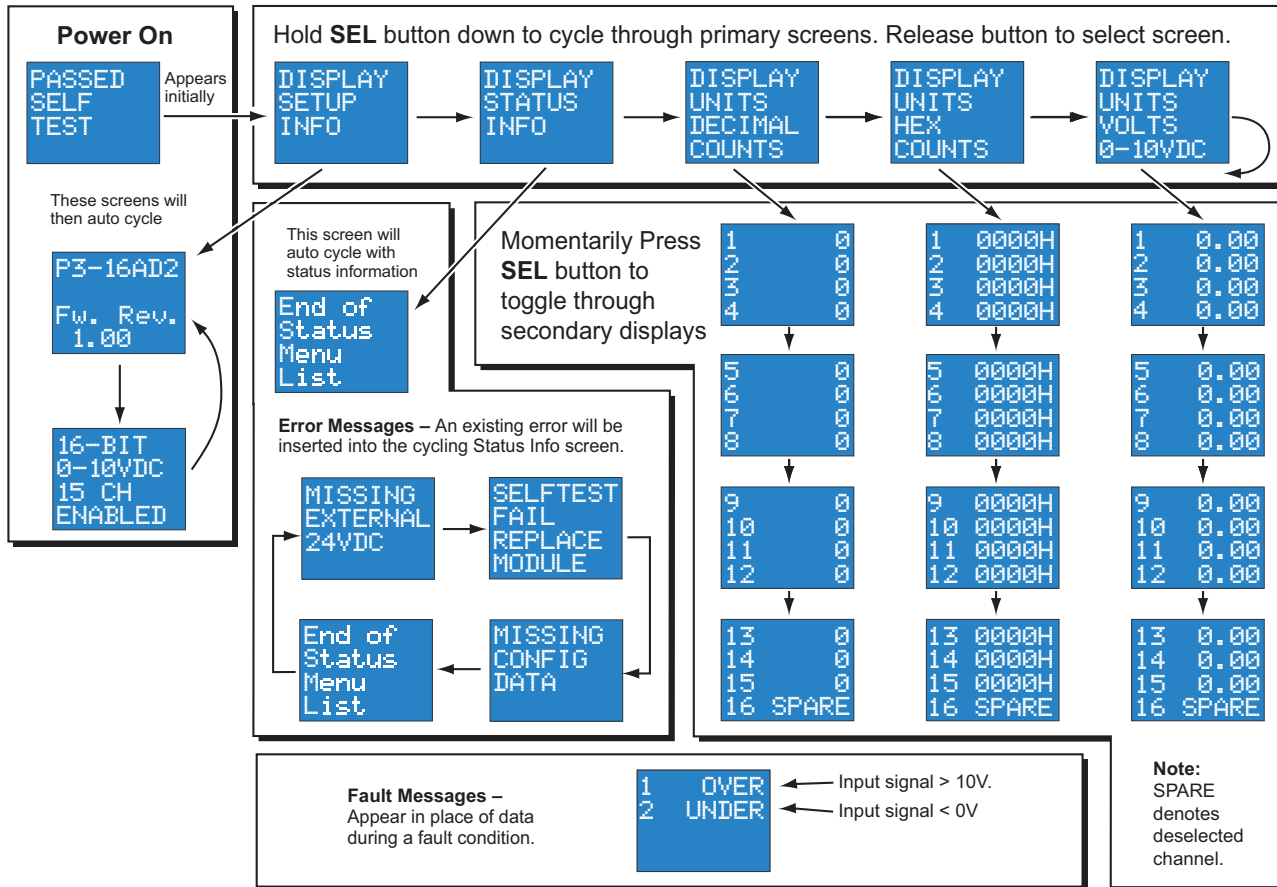

Document Name	Edition/Revision	Date
P3-16AD-2-M	1st Ed. Rev. A	12/20/2013

Copyright 2014, AutomationDirect.com Incorporated/All Rights Reserved Worldwide