

WARNING: To minimize the risk of potential safety problems, you should follow all applicable local and national codes that regulate the installation and operation of your equipment. These codes vary from area to area and it is your responsibility to determine which codes should be followed, and to verify that the equipment, installation, and operation are in compliance with the latest revision of these codes.

Equipment damage or serious injury to personnel can result from the failure to follow all applicable codes and standards. We do not guarantee the products described in this publication are suitable for your particular application, nor do we assume any responsibility for your product design, installation, or operation.

If you have any questions concerning the installation or operation of this equipment, or if you need additional information, please call Technical Support at 770-844-4200.

This publication is based on information that was available at the time it was printed. At AutomationDirect.com[®] we constantly strive to improve our products and services, so we reserve the right to make changes to the products and/or publications at any time without notice and without any obligation. This publication may also discuss features that may not be available in certain revisions of the product.

Connector Specifications

Connector Type	24-Pin Molex Style 43025-2400
Number of Pins	24
Pin Spacing	3x3mm (0.118x0.118)



P2-16DAL-2 Analog Output

The P2-16DAL-2 Low Resolution Voltage Analog Output Module provides sixteen channels of 0–10VDC outputs for use with the Productivity2000 System.

Warning	1
Connector Specifications	1
General Specifications	2
Output Specifications	2
Wiring Diagram and Schematic	3
Module Installation Procedure	4
QR Code	4
Hot Swap Information	4
Wiring Options	5
Module Configuration	5
Linear Scaling	6
Non-Linear Scaling	6

Terminal Block sold separately, (see wiring options on page 5).
 Warranty: Thirty-day money-back guarantee. Two-year limited replacement. (See www.productivity2000.com for details).

General Specifications

Surrounding Temperature	0° to 60°C (32° to 140°F)
Storage Temperature	-20° to 70°C (-4° to 158°F)
Humidity	5 to 95% (non-condensing)
Environmental Air	No corrosive gases permitted
Vibration	IEC60068-2-6 (Test Fc)
Shock	IEC60068-2-27 (Test Ea)
Field to Logic Side Isolation	1800VAC applied for 1 second
Insulation Resistance	> 10MΩ @ 500VDC
Heat Dissipation	8W
Enclosure Type	Open Equipment
Module Keying to Backplane	Electronic
Module Location	Any I/O slot in a Productivity2000 System
Field Wiring	Use ZIPLink Wiring System ONLY. See "Wiring Options" on page 5. Must use copper conductors 75°C or equivalent.
EU Directive	See the "EU Directive" topic in the Productivity Suite Help File. Information can also be obtained at: www.productivity2000.com
Terminal Type	24 Position ZIPLink Connector
Weight	100g (3.5 oz)
Agency Approvals	UL 61010-1 and UL 61010-2-201 File E139594, Canada and USA CE (EN 61131-2 EMC, EN 61010-1 and EN 61010-2-201 Safety)*

*Meets EMC and Safety requirements. See the D.O.C. for details.

Output Specifications

Output Channels	16
Module Signal Input Range	0–10 V
Output Signal Resolution	12-bit
Resolution Value of LSB (least significant bit)	0–10 V = 2.44 mV per count 1 LSB = 1 count
Data Range	0 to 4095 counts
Output Type	Voltage sourcing at 10mA max. (1 common)
Output Value in Fault Mode	0V
Load Impedance	0.2 Ω typical
Maximum Capacitive Load	0.01 μF maximum
Allowed Load Type	Grounded
Maximum Inaccuracy	0.5% of range (including temperature drift)
Maximum Full Scale Calibration Error	±0.2% of range maximum voltage
Maximum Offset Calibration Error	±0.2% of range maximum
Accuracy vs. Temperature	±75 PPM / °C maximum full-scale calibration change (±0.0025% of range / °C)
Max Crosstalk at DC, 50/60Hz	-72dB, 1 LSB
Linearity Error (End to End)	±4 LSB maximum, (±0.1% of full scale) Monotonic with no missing codes
Output Stability and Repeatability	±2% LSB after 10 min. warm up period
Output Ripple	±0.1% of full scale
Output Settling Time	300μs max., 5μs min. (full scale range)
All Channel Update Rate	1ms
Maximum Continuous Overload	Outputs current limited to 40mA typical; Continuous overloads on multiple outputs can damage the module.
Type of Output Protection	0.1μF Transient Suppressor
External 24VDC Power Required	24VDC (-20% / + 25%), 265mA

Voltage Output Circuits

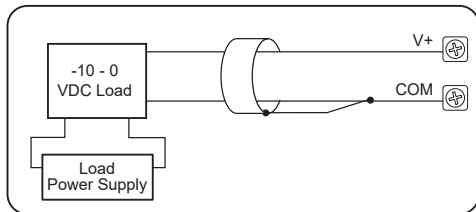
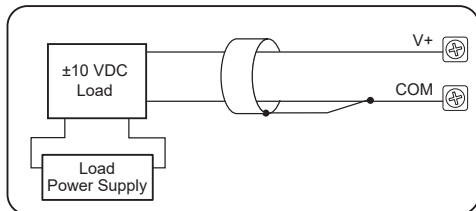
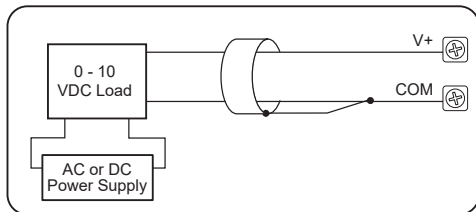

24VDC±10%

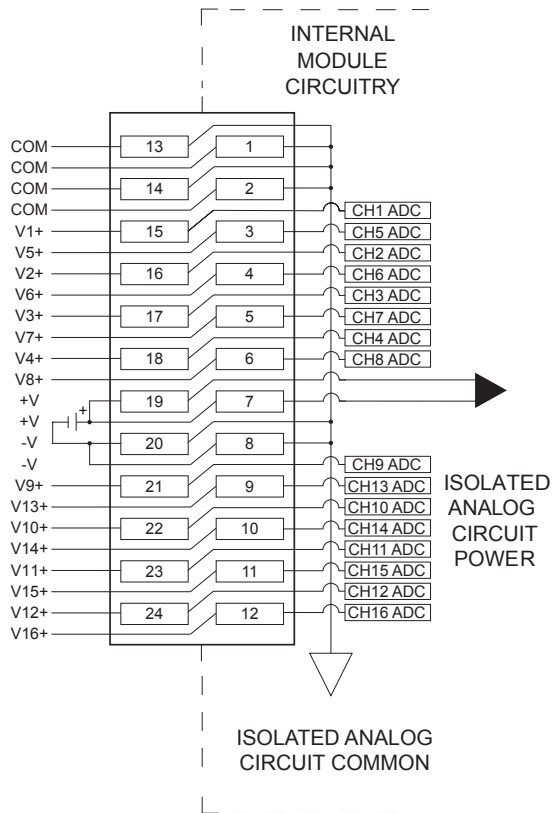

Module Installation

WARNING: Do not apply field power until the following steps are completed. See hot-swapping procedure for exceptions.

Step One: Align module catch with base slot and rotate module into connector.

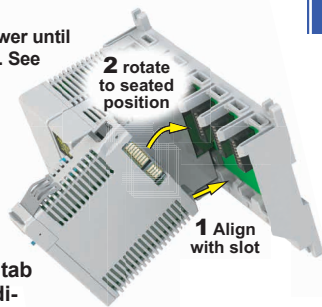

Step Two: Pull top locking tab toward module face. Click indicates lock is engaged.

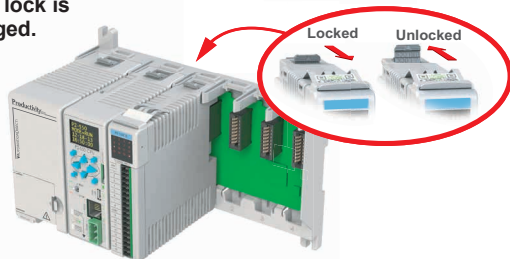

Step Three: Attach field wiring using the removable terminal block or ZIPLink wiring system.



QR Code



Use any QR Code reader application to display the module's product insert.

Caution: If possible, remove field power prior to proceeding. If not, then **EXTREME** care **MUST** be taken to prevent damage to the module, or even personal injury due to a short circuit from the live terminal block.

Important Hot-Swap Information

The Productivity2000 PAC supports hot-swap!

Individual modules can be taken offline, removed, and replaced while the rest of the PAC system continues controlling your process. Before attempting to use the hot-swap feature, be sure to read the hot-swap topic in the programming software's help file or our online documentation at AutomationDirect.com for details on how to plan your installation for use of this powerful feature.

Wiring Options

1 ZIPLink Feed Through Modules and Cables¹

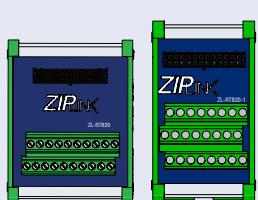

0.5 m (1.6 ft) cable
1.0 m (3.3 ft) cable
2.0 m (6.6 ft) cable



ZL-RTB20
ZL-RTB20-1

ZL-P2-CBL24
ZL-P2-CBL24-1
ZL-P2-CBL24-2

2 Terminal Block with pigtail cable



1.0 m (3.3 ft) cable
2.0 m (6.6 ft) cable

ZL-P2-CBL24-1P
ZL-P2-CBL24-2P

3 Accessories²

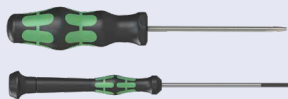
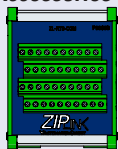

ZL-RTB-COM

TW-SD-SL-1

TW-SD-MSL-1

1. Cable + ZIPLink Module = Complete System

2. ZL-RTB-COM provides a common connection point for power or ground

Module Configuration

Using the Hardware Configuration tool in the Productivity Suite programming software, drag and drop the P2-16DAL-2 module into the base configuration.

Select **Automatic Module Verification** or **No Verification and Enable Hot Swap**. If desired, assign a **User Tagname** to each input point (channel) selected and to each **Status Bit Item**.

P2-16DAL-2

16CH, 12-BIT, VOLTAGE, ANALOG OUTPUT

Automatic Module Verification
 No Verification and Enable Hot Swap

Point	User Tagname	Stop Mode Value
1	AOS32-0.1.6.1	0
2	AOS32-0.1.6.2	0
3	AOS32-0.1.6.3	0
4	AOS32-0.1.6.4	0
5	AOS32-0.1.6.5	0
6	AOS32-0.1.6.6	0
7	AOS32-0.1.6.7	0
8	AOS32-0.1.6.8	0
9	AOS32-0.1.6.9	0
10	AOS32-0.1.6.10	0
11	AOS32-0.1.6.11	0
12	AOS32-0.1.6.12	0

Status Bit	User Tagname
Module Failed	MST-0.1.6.25
Missing 24V	MST-0.1.6.26

Document Name	Edition/Revision	Date
P2-16DAL-2-DS	2nd Ed.	9/11/2019

Copyright 2015, AutomationDirect.com Incorporated/All Rights Reserved Worldwide