

# SPECIFICATIONS

---



# CHAPTER 2

## In This Chapter...

P2CDS-622 CPU.....	2-2
P2CDS-622 CPU Features .....	2-4
P2CDS-622 CPU Programmable RS232/485 Ports.....	2-5
P2CDS-622 CPU Ethernet Ports .....	2-7
P2CDS-622 CPU USB Type C Programming Port .....	2-8
P2CDS-622 CPU microSD Slot.....	2-9
microSD Slot.....	2-9
P2CDS-622 CPU Battery Installation .....	2-10
Battery (Optional) .....	2-10
I/O Modules Overview .....	2-11
P2CDS-622 Wiring, Installation and Safety .....	2-14

# P2CDS-622 CPU

The P2CDS-622 CPU is a Productivity2000-series compatible CPU. It is compatible with all Productivity2000 modules, with the exception of P2-RS and P1-RX remote slaves, PS-AMC motion controllers, and the following Modules: P2-HSI, P2-HSO, P2-02HSC, and P2-SCM.

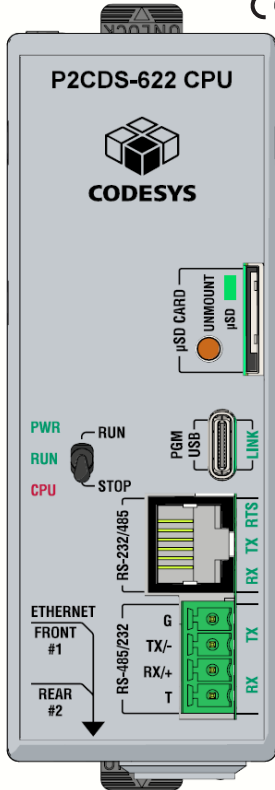

CPU Specifications	
User Memory	50MB (Includes program, data and documentation)
Memory Type	Flash and Battery Backed RAM
Retentive Memory	1MB (Retain 800KB / Retain-Persistent 200KB)
Scan Time	550us (5K Boolean Logic)
Interfaces	<p><b>USB IN:</b> USB 2.0 (single port), Program, Monitor, Debug, Firmware Update</p> <p><b>ETHERNET:</b> Two independent 10/100Mbps RJ-45 connectors</p> <p><b>PROTOCOLS:</b> Modbus TCP and RTU Client/Server, EtherNet/IP Scanner/Adapter, MQTT with TLS, Email, SMTP Client</p> <p><b>VISUALIZATION:</b> "WebVisu" (Web Server)</p> <p><b>RS232/485:</b> RJ12 connector</p> <p><b>RS232/485:</b> 4-position Terminal Block</p>
Data Logging	microSD card slot
Hardware Topologies	<p><b>Four (4) Base Groups:</b> Four (4), seven (7), eleven (11), and fifteen (15) slot bases</p> <p><b>Supported Modules:</b> All P2 Discrete Input and Output modules, all P2 Analog Input and Output modules, P2-04PWM</p> <p><b>Unsupported Modules:</b> Remote Slaves (P1-RX, P2-RS) and P2-HSO, P2-HSI, P2-02HSC, and P2-SCM modules.</p>
IEC 61131-3 Supported Editor Types	<p>Functional Block Diagram (FBD)</p> <p>Structured Text (ST)</p> <p>Sequential Function Charts (SFC)</p> <p>Ladder Diagram (LD)</p> <p>Continuous Function Chart (CFC)</p>
Real Time Clock Accuracy	<p>±2s per day typical at 25°C</p> <p>±10s per day maximum at 60°C</p>

**IMPORTANT!**



**Hot-Swapping Information**

Note: This device cannot be Hot Swapped.

# P2CDS-622 CPU Specifications, cont'd

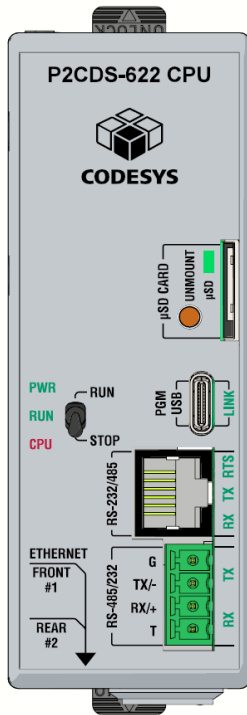

P2CDS-622 CPU

## General Specifications

Operating Temperature	0° to 60°C (32° to 140°F)
Storage Temperature	-20° to 70°C (-4° to 158°F)
Humidity	5 to 95% (non-condensing)
Altitude	2,000 meters, max.
Pollution Degree	2
Environmental Air	No corrosive gases permitted
Vibration	IEC60068-2-6 (Test Fc)
Shock	IEC60068-2-27 (Test Ea)
Overvoltage Category	II
Heat Dissipation	4800mW
Enclosure Type	Open Equipment
Module Location	Controller slot in the local base in a Productivity2000 System
Weight	139g (4.9 oz)
Agency Approvals	UL 61010-1 and UL 61010-2-201 File E139594, Canada & USA CE (EN 61131-2 EMC, EN 61010-1 and EN 61010-2-201 Safety)

## CPU Run/Stop Switch

RUN position	Executes user program, run-time edits possible
STOP position	Does not execute user program, normal program load position

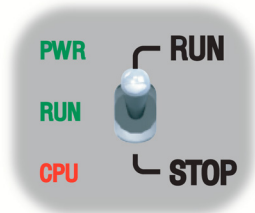

## CPU Status Indicators

PWR	Green LED is illuminated when power is ON
RUN	Green LED is illuminated when CPU is in RUN mode
CPU	Red LED is illuminated during power ON reset, power down, or watch-dog time-out

# P2CDS-622 CPU Features

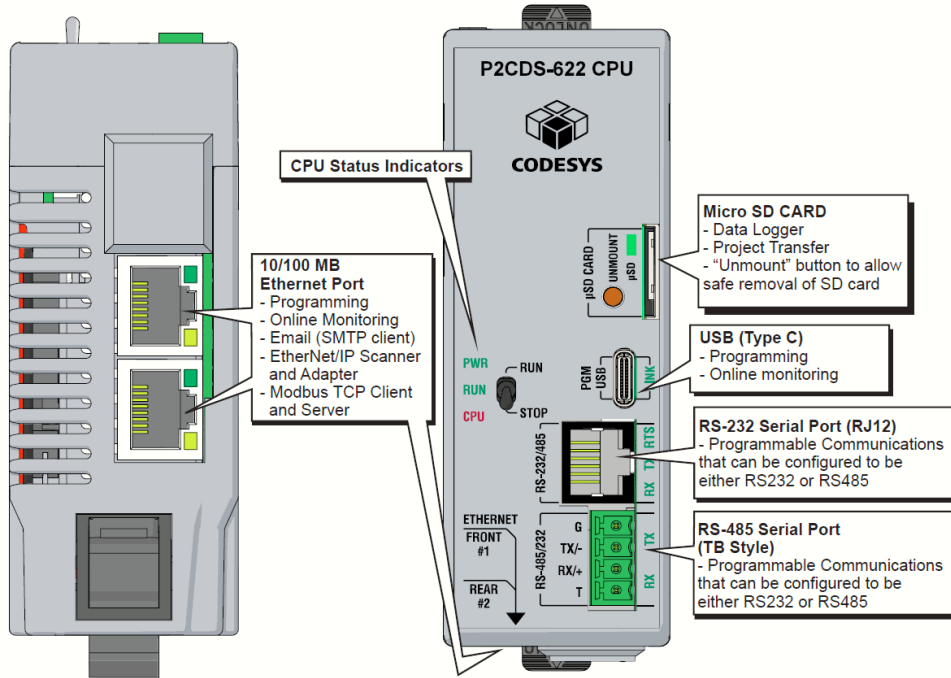

# P2CDS-622 CPU Programmable RS232/485 Ports

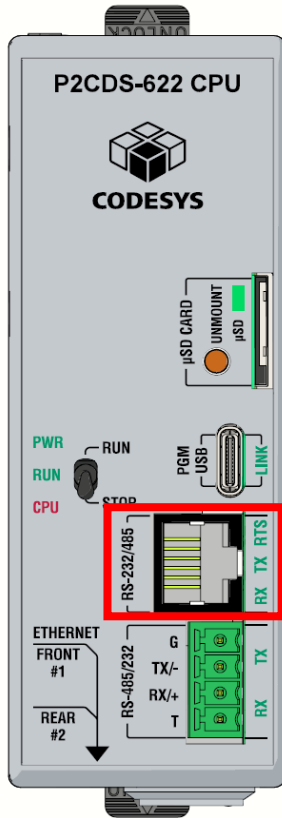

The [P2CDS-622](#) CPU RJ12 style connector and a 4-position terminal may each be programmed for RS232 or RS485 connections. These ports may be used for:

- Modbus RTU Master connections
- Modbus RTU Slave connections
- ASCII full or half duplex communications
- Custom Protocol Incoming and Outgoing communications

## RS232 Specifications

TXD	RS232 Transmit output
RXD	RS232 Receive input
RTS	Handshaking output for modem control (RJ12 Only)
GND	Logic ground
Maximum Output Load (TXD/RTS)	3kΩ, 1000 pf
Minimum Output Voltage Swing	±5V
Output Short Circuit Protection	±15mA

## RJ12 Connector Specifications

Description	<p>Programmable RS232/485 Port</p> <ul style="list-style-type: none"> <li>- Non-isolated RS232 DTE port connects the CPU as a Modbus/ASCII master or slave to a peripheral device. Includes ESD and built in surge protection</li> <li>- Non-isolated RS485 port connects the CPU as a Modbus/ASCII master or slave to a peripheral device. Includes ESD/EFT protection and automatic echo cancellation when transmitter is active</li> </ul>
Data Rates	Selectable, 1200, 2400, 4800, 9600, 19200, 33600, 38400, 57600, and 115200
+5V Cable Power	210mA maximum at 5V, ±5%. Reverse polarity and overload protected.
Port Status LED	Green LED illuminated when active for TXD, RXD and RTS
Cable Options	<p>EA-MG-PGM-CBL                  D2-DSCBL                  USB-RS232-1 with D2-DSCBL                  FA-CABKIT</p>

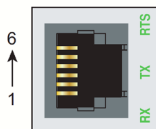

6-pin RJ12 Female Modular Connector

Pin #	RS232	RS485
6	GND	GND
5	RTS	
4	TXD	TXRX-
3	RXD	TXRX+
2	+5V, 210mA	Do not connect
1	GND	GND

# P2CDS-622 CPU Programmable RS485/232 Ports

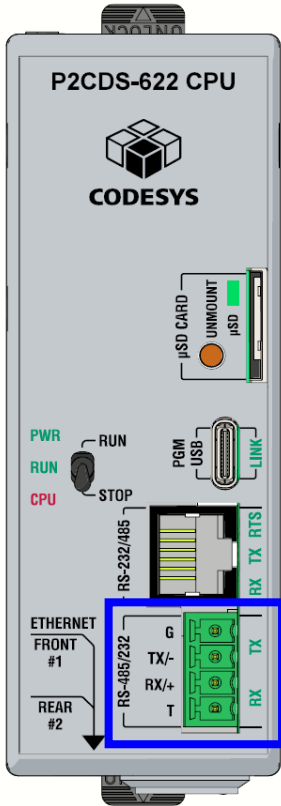

RS485 Specifications	
TXD+/RXD+	RS485 transceiver high
TXD-/RXD-	RS485 transceiver low
GND	Logic Ground
Input Impedance	19kΩ
Termination Resistance (TB Jumper wire "T" to "+")	120Ω. To use, add jumper between pin 1 and pin 2. Resistor is internally connected between pins 1 and 3.
Maximum Load	50 transceivers, 19kΩ each, 60Ω termination
Output Short Circuit Protection	±250mA, thermal shut-down protection
Electrostatic Discharge Protection	Contact ±4KV, Air ±8KV per IEC61000-4-2 (Cable is installed for testing)
Electrical Fast Transient Protection	±1KV per IEC61000-4-4
Minimum Differential Output Voltage	1.5 V with 60Ω load
Fail Safe Inputs	Logic high input state if inputs are connected
Maximum Common Mode Voltage	-7.5 V to 12.5 V

Terminal Block Specifications	
Description	<p>Programmable RS485/232 Port</p> <ul style="list-style-type: none"> <li>- Non-isolated RS232 DTE port connects the CPU as a Modbus/ASCII master or slave to a peripheral device. Includes ESD and built in surge protection</li> <li>- Non-isolated RS485 port connects the CPU as a Modbus/ASCII master or slave to a peripheral device. Includes ESD/EFT protection and automatic echo cancellation when transmitter is active</li> </ul>
Data Rates	Selectable, 1200, 2400, 4800, 9600, 19200, 33600, 38400, 57600, and 115200
Port Status LED	Green LED illuminated when active for TXD and RXD
Cable Options	Go to <a href="http://AutomationDirect.com">AutomationDirect.com</a> for RS232 and 485 cable selection.

## 4 Position Terminal Block

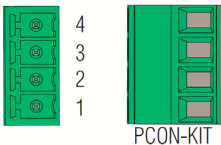

Pin #	RS232	RS485
4	GND	GND
3	TXD	TXRX-
2	RXD	TXRX+
1	Do not connect	TERMINATE

# P2CDS-622 CPU Ethernet Ports

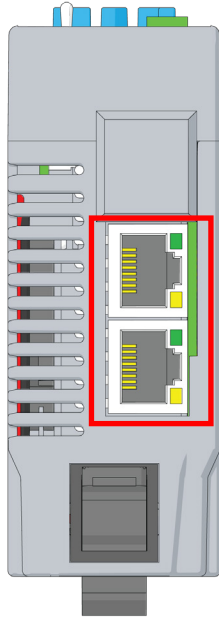

P2CDS-622 Bottom View

**Ethernet Port (RJ45 style connectors on bottom of CPU) used for:**

- Connection to a PC running the programming software
- Modbus TCP Client (64 Servers) connections (Modbus requests sent from the CPU)
- Modbus TCP Server (16 Clients) connections (Modbus requests received by the CPU)
- EtherNet/IP Scanner (64 Adapters)
- EtherNet/IP Adapter (4 scanners) with 8 connections per device.
- Outgoing E-mail
- MQTT Client (4 brokers)
- Rear port does not have Default Gateway or DNS capability.

Ethernet Specifications	
Port Name	ETHERNET
Description	Standard transformer isolated Ethernet port with built-in surge protection for programming, online monitoring, firmware, MQTT, Email (SMTP client), Modbus/TCP client/server connections (fixed IP or DHCP) and Ethernet/IP Scanner/Adapter connections.
Transfer Rate	RJ45 Yellow LED Off = 10Mbps / On = 100 Mbps
Port Status LED	RJ45 Green LED Solid when network LINK is established. Flashes when port is active (ACT).

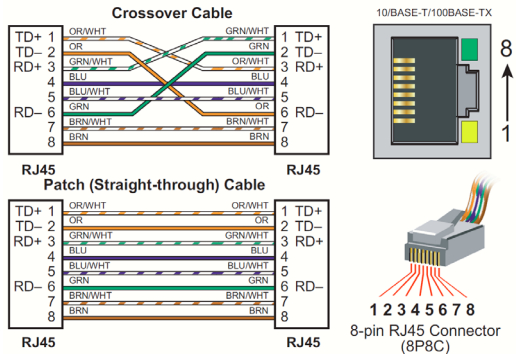

# P2CDS-622 CPU USB Type C Programming Port

The P2CDS-622 CPU has a standard USB C Slave input for programming and online monitoring, with built-in surge protection. Capable of 480Mbps.

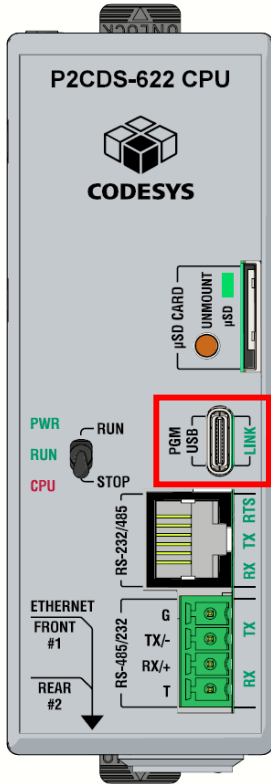

USB Type C Specifications	
Port Name	USB C
Description	Standard USB C Slave input for programming and online monitoring, with built-in surge protection.
Transfer Rate	480Mbps
Port Status LED	Green LED is illuminated when LINK is established to programming software.
Cables	USB Type A to USB Type C: 6ft cable part # USB-CBL-AC6

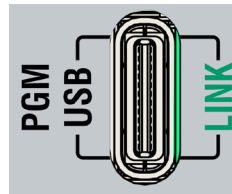



## P2CDS-622 CPU microSD Slot

### microSD Slot

The SD Card can be used for the Data Logging in the project or program transfer.

When an SD Card is inserted, the “ $\mu$ SD” LED will flash green a few times then stay on steady green.

The “Unmount” button is pressed prior to removing the SD card. When pressed, the  $\mu$ SD port LED flashes momentarily during the unmounting and then will be off indicating it is safe to remove the SD Card.

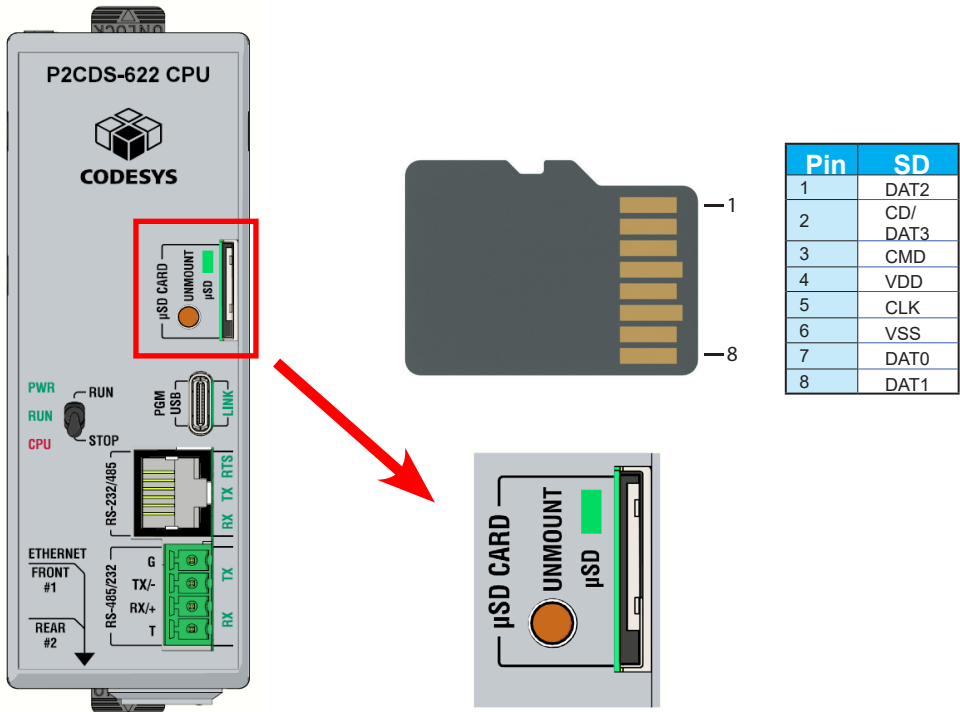

### microSD Specifications

Port Name	microSD			
Description	Standard microSD socket for data logging or program transfer			
Maximum Card Capacity	32GB			
Transfer Rate (ADATA microSDHC Class 4 memory card)	Mbps	Minimum	Typical	Maximum
	Read	14.3	14.4	14.6
	Write	4.8	4.9	5.1
Port Status LED	Green LED is illuminated when card is inserted and detected			

# P2CDS-622 CPU Battery Installation

## Battery (Optional)

A battery is included with the CPU module but is not installed. The battery may be installed in order to retain the Time and Date along with any tagname values that are set up as retentive. The battery is not needed for program backup.

**Step One:**

Press spring lock and swing battery compartment away from CPU.

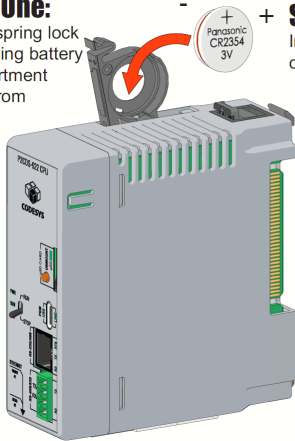

**Step Two:**

Insert battery and close compartment.

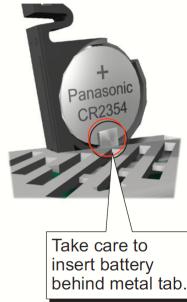

Battery (Optional)	
D2-BAT-1	Coin type, 3.0 V Lithium battery, 560mA, battery number CR2354
<b>Note:</b> Although not needed for program backup, an uninstalled battery is included with the P2CDS-622. Install this battery if you want the CPU to retain the Time and Date along with any Tagname values that you have configured as retentive.	

# I/O Modules Overview

A variety of analog I/O modules from our Productivity2000 line are available for use with the P2CDS-622 CPU. Please refer to Productivity2000 manual [Chapter 2](#) for detailed technical specifications.

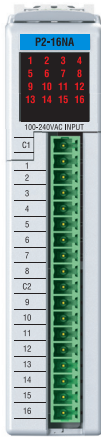

Discrete Input Modules

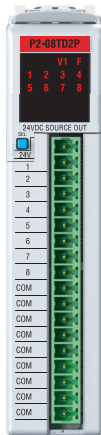

Discrete Output Modules

Productivity <sup>®</sup> 2000 I/O Modules Supported		
Part Number	Number of Points	Description
<b>Discrete Input Modules</b>		
P2-08SIM	8	Input Simulator Module
P2-08ND3-1	8	Sinking/Sourcing 12–24 VDC
P2-16ND-TTL	16	Sinking/Sourcing 5VDC
P2-16ND3-1	16	Sinking/Sourcing 12–24 VDC
P2-32ND3-1	32	Sinking/Sourcing 12–24 VDC
P2-08NE3	8	Sinking/Sourcing 24V AC/DC
P2-16NE3	16	Sinking/Sourcing AC/DC
P2-32NE3	32	Sinking/Sourcing 24V AC/DC
P2-08NAS	8	AC Isolated 100–120 VAC
P2-16NA	16	AC Isolated 100–240 VAC
<b>Discrete Output Modules</b>		
P2-08TD1S	8	Isolated Sinking
P2-08TD2S	8	Isolated Sourcing
P2-15TD1	15	Sinking
P2-15TD2	15	Sourcing
P2-08TD1P	8	Sinking, Protected
P2-08TD2P	8	Sourcing, Protected
P2-16TD-TTL	16	Sinking/Sourcing 5VDC
P2-16TD1P	16	Sinking, Protected
P2-16TD2P	16	Sourcing, Protected
P2-32TD1P	32	Sinking, Protected
P2-32TD2P	32	Sourcing, Protected
P2-08TAS	8	Isolated AC
P2-16TA	16	AC Output
P2-06TRS	6	Isolated Relay
P2-08TRS	8	Isolated Relay
P2-16TR	16	Relay Output

# I/O Modules Overview, continued

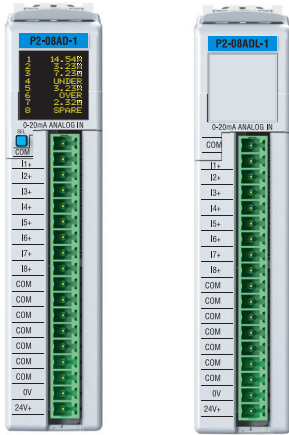

Analog Input Modules

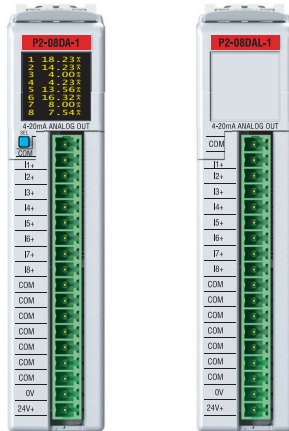

Analog Output Modules

Productivity <sup>®</sup> 2000 I/O Modules Supported		
Part Number	Number of Points	Description
<b>Analog Input Modules</b>		
P2-04AD	4	Voltage/Current
P2-04AD-1	4	Current
P2-04AD-2	4	Voltage
P2-08AD-1	8	Current
P2-08AD-2	8	Voltage
P2-08ADL-1*	8	Current
P2-08ADL-2*	8	Voltage
P2-16AD-1	16	Current
P2-16AD-2	16	Voltage
P2-16ADL-1*	16	Current
P2-16ADL-2*	16	Voltage
P2-06RTD	6	RTD Input
P2-08THM	8	Thermocouple Input
P2-08NTC	8	Thermistor Input
<b>Analog Output Modules</b>		
P2-04DA	4	Voltage/Current
P2-04DA-1	4	Current
P2-04DA-2	4	Voltage
P2-04DAL-1*	4	Current
P2-04DAL-2*	4	Voltage
P2-08DA-1	8	Current
P2-08DA-2	8	Voltage
P2-08DAL-1*	8	Current
P2-08DAL-2*	8	Voltage
P2-16DA-1	16	Current
P2-16DA-2	16	Voltage
P2-16DAL-1*	16	Current
P2-16DAL-2*	16	Voltage

# I/O Modules Overview, continued

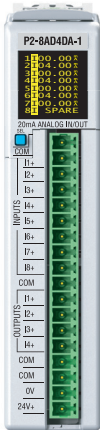

**Combination  
Analog I/O Module**

Productivity® 2000 I/O Modules Supported		
Part Number	Number of Points	Description
<b>Analog Combination Modules</b>		
P2-08AD4DA-1	8/4	Analog Input/Output (Current)
P2-8AD4DA-2	8/4	Analog Input/Output (Voltage)

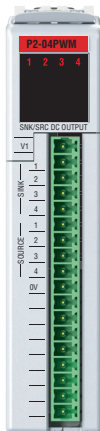

**Specialty Module**

Specialty Modules	
Part Number	Description
<i>P2-04PWM</i>	High-speed pulse-width modulation



**NOTE: Unsupported Modules:** *Remote Slaves (P2-RS) and Intelligent modules (P2-HSO, P2-HSI, P2-02HSC, and P2-SCM).*

# P2CDS-622 Wiring, Installation and Safety

P2CDS-622 is supported by Productivity2000 system hardware and has the same installation and safety guidelines. Please refer to [Chapter 5 "Installation and Wiring"](#) in the P2000 user manual for details concerning installation procedures and wiring suggestions.