

CPU Specifications															
User Memory	50MB (Includes program, data and documentation)														
Memory Type	Flash and Battery Backed RAM														
Retentive Memory	500kB														
Scan Time	1.7 ms (1K Boolean, 240 I/O)														
External Power Required	24VDC $\pm 2\%$ @ 5W plus 1.25 W per additional I/O module In-Rush 35A** See page 6 for Power Supply Options														
Protection Circuit	Edison S5062-R, Time Delay, 2A Fuse (15 I/O Modules)														
Communications; 5 Integrated Ports	<p>USB: Programming, Monitoring, Debug, Firmware</p> <p>ETHERNET: (10/100Mbps Ethernet) Programming, Monitoring, Debug, Firmware, Email SMTP Client, Modbus TCP Client (32 Servers) and Server (16 Clients), EtherNet/IP Scanner (32 Adapters) and Adapter (4 scanners) with 8 connections per device. Custom Protocol over Ethernet, ProNet, MQTT.</p> <p>REMOTE I/O: 16 GS Drives*, 4 ProtosX TCP couplers, 4 P1-RX remote bases, 1 PS-AMC module</p> <p>RS-232: (RJ12, 1200-115.2k Baud) ASCII, Modbus</p> <p>RS-485: Removable Terminal Included, (1200-115.2k Baud) ASCII, Modbus RTU</p>														
Data Logging	MicroSD card slot														
Hardware Limits of System	<p>5 Base Groups: 1 local (P1-550) + 4 Remote (P1-RX)</p> <p>752 Hardware I/O Points All local and remote 16-point I/O Modules)</p>														
Instruction Types	<table border="0"> <tr> <td>Application Functions</td> <td>PID</td> </tr> <tr> <td>Array Functions</td> <td>Program Control</td> </tr> <tr> <td>Counters/Timers</td> <td>String Functions</td> </tr> <tr> <td>Communications</td> <td>System Functions</td> </tr> <tr> <td>Data Handling</td> <td>Contacts</td> </tr> <tr> <td>Drum Sequencers</td> <td>Coils</td> </tr> <tr> <td>Math Functions</td> <td>Motion Control</td> </tr> </table>	Application Functions	PID	Array Functions	Program Control	Counters/Timers	String Functions	Communications	System Functions	Data Handling	Contacts	Drum Sequencers	Coils	Math Functions	Motion Control
Application Functions	PID														
Array Functions	Program Control														
Counters/Timers	String Functions														
Communications	System Functions														
Data Handling	Contacts														
Drum Sequencers	Coils														
Math Functions	Motion Control														
Real Time Clock Accuracy	<p>$\pm 2s$ per day typical at 25°C</p> <p>$\pm 10s$ per day maximum at 60°C</p>														

*GS drive requires communication module/ card **Rev B and Higher

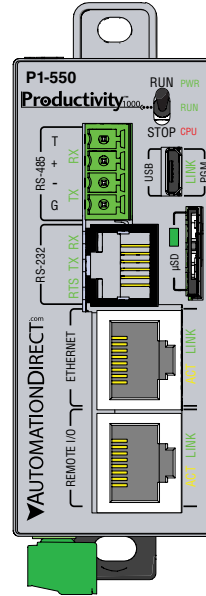

P1-550 CPU

The P1-550 is a full-featured, high-performance CPU for use with the Productivity1000 System.

CPU Specifications	1
CPU Front Panel	2
Module Installation Procedure	2
Battery Installation Procedure	3
Micro SD Specifications	3
Port Specifications	4
Micro USB Specifications	5
CPU Status Indicators	6
CPU Stop/Run Switch Specifications	6
Removable Terminal Block Specifications	6
General Specifications	8
Warning	8

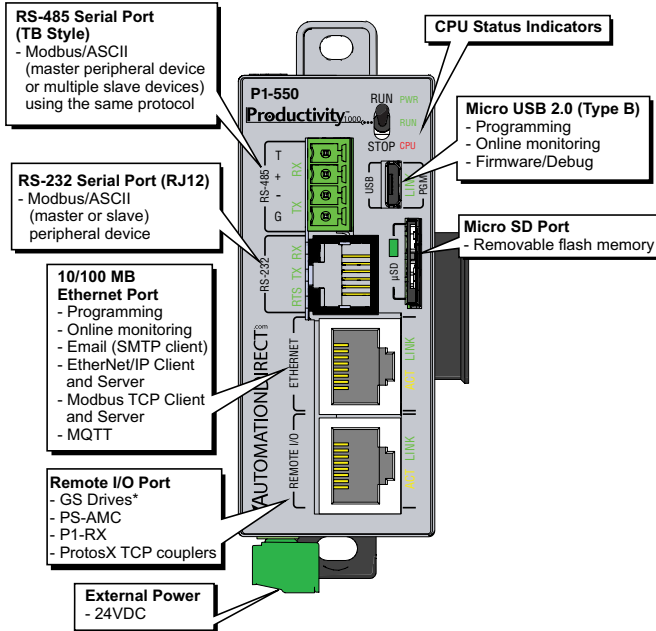

*GS Drive requires communications module/card
Feature availability may require current software version.

WARNING: Do not add or remove modules with field power applied.

Step One: With latch in "locked" position, align connectors on the side of each module and stack by pressing together. Click indicates lock is engaged.

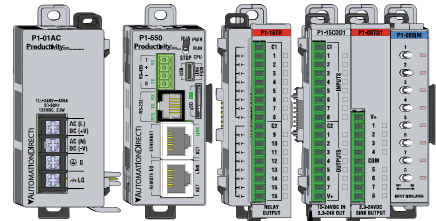

Step Two: Attach field wiring using the removable terminal block or ZIPLink wiring system.

Check all latches are secure after modules are connected.

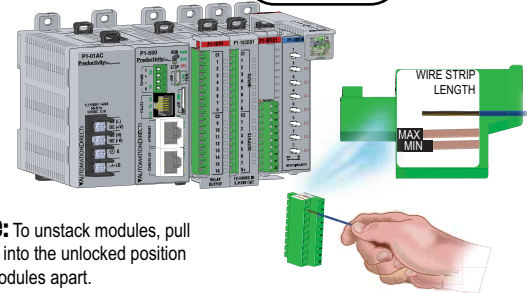

Step Three: To unstack modules, pull locking latch up into the unlocked position and then pull modules apart.

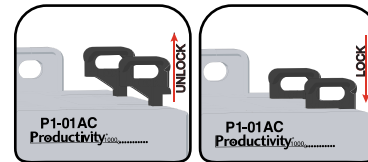

Battery Installation Procedure

Step One:

Open battery compartment located on the top of the CPU and pull up to locked position.

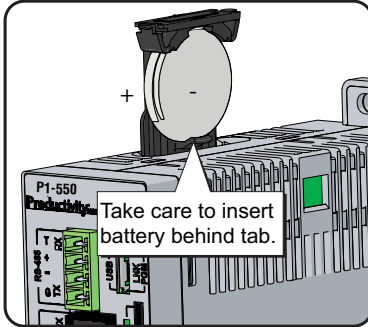
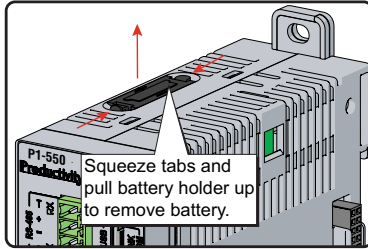

Step Two:

Insert battery under top two tabs in battery compartment. Press and snap battery behind bottom tab then close the battery compartment.

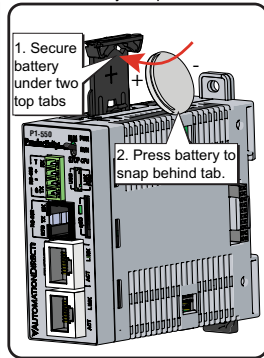

Battery (Optional)

D2-BAT-1 Coin type, 3.0V Lithium battery, 560mA, battery number CR2354

Note: Although not needed for program backup, an uninstalled battery is included with the P1-550. Install this battery if you want the CPU to retain the Time and Date along with any Tagname values that you have set up as retentive.

microSD Specifications

Port Name	microSD			
Description	Standard microSD socket for data logging			
Maximum Card Capacity	32GB			
Transfer Rate (ADATA microSDHC Class 4 memory card)	Minimum	Typical	Maximum	
	Read	14.3	14.4	14.6
	Write	4.8	4.9	5.1
Port Status LED	Green LED is illuminated when card is inserted/detected			

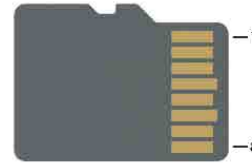

NOTE: Card not included with unit.

Pin	SD
1	DAT2
2	CD/DAT3
3	CMD
4	VDD
5	CLK
6	VSS
7	DAT0
8	DAT1

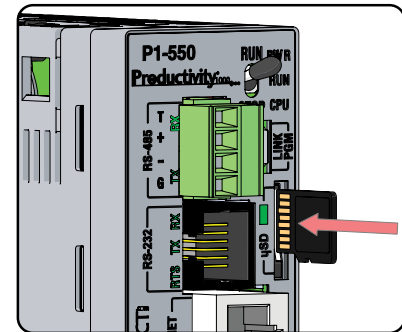

Port Specifications

RS-232 Specifications

Port Name	RS-232
Description	Non-isolated RS-232 DTE port connects the CPU as a Modbus/ASCII master or slave to a peripheral device. Includes ESD and built-in surge protection
Data Rates	Selectable, 1200, 2400, 4800, 9600, 19200, 33600, 38400, 57600, and 115200
+5V Cable Power Source	210mA maximum at 5V, ±5%. Reverse polarity and overload protected
TXD	RS-232 Transmit output
RXD	RS-232 Receive input
RTS	Handshaking output for modem control
GND	Logic ground
Maximum Output Load (TXD/RTS)	3kΩ, 1000 pf
Minimum Output Voltage Swing	±5 V
Output Short Circuit Protection	±15 mA
Port Status LED	Green LED is illuminated when active for TXD, RXD and RTS
Cable Options	EA-MG-PGM-CBL D2-DSCBL USB-RS232-1 with D2-DSCBL FA-CABKIT FA-ISOCAN for converting RS-232 to isolated RS-485

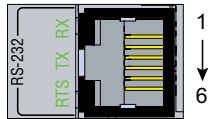

6-pin RJ12 Female Modular Connector

Pin #	Signal
1	GND Logic Ground
2	+5V 210mA Maximum
3	RXD RS-232 Input
4	TXD RS-232 Output
5	RTS RS-232 Output
6	GND Logic Ground

RS-485 Port Specifications

Port Name	RS-485
Description	Non-isolated RS-485 port connects the CPU as a Modbus/ASCII master or slave to a peripheral device. Includes ESD/EFT protection and automatic echo cancellation when transmitter is active
Data Rates	Selectable, 1200, 2400, 4800, 9600, 19200, 33600, 38400, 57600, and 115200
TXD+/RXD+	RS-485 transceiver high
TXD-/RXD-	RS-485 transceiver low
GND	Logic ground
Input Impedance	19kΩ
Termination Resistance (TB Jumper wire "T" to "+")	120Ω. To use, add jumper between "T" and "+". Resistor is internally connected between "T" and "-".
Maximum Load	50 transceivers, 19kΩ each, 60Ω termination
Output Short Circuit Protection	± 250mA, thermal shut-down protection
Electrostatic Discharge Protection	± 8KV per IEC1000-4-2
Electrical Fast Transient Protection	± 1KV per IEC1000-4-4
Minimum Differential Output Voltage	1.5 V with 60Ω load
Fail Safe Inputs	Logic high input state if inputs are unconnected
Maximum Common Mode Voltage	-7.5 V to 12.5 V
Port Status LED	Green LED illuminated when active for TXD and RXD
Cable Options	Go to AutomationDirect.com for RS-232 and RS-485 cables

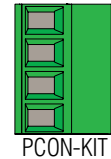
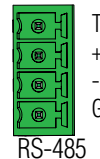

Pin #	Signal
T	TERMINATION
+	TXD+/RXD+
-	TXD-/RXD-
G	GND

Port Specifications

Ethernet Specifications		
Port Name	ETHERNET	REMOTE I/O
Description	Standard transformer isolated Ethernet port with built-in surge protection for programming, online monitoring and Ethernet communication protocols. See table on page 1 for supported devices and protocols.	Standard transformer isolated Ethernet port with built-in surge protection for connection to supported remote I/O devices. See table on page 1 for supported remote I/O devices.
Transfer Rate	10Mbps (Orange LED) and 100Mbps (Green LED) (auto-crossover)	
Port Status LED	LED is solid when network LINK is established. LED flashes when port is active (ACT).	

Micro USB Type B Slave Input Specifications	
Port Name	MICRO USB
Description	Standard Micro USB Slave input for programming and online monitoring, with built-in surge protection. Not compatible with older full speed USB devices.
Transfer Rate	480 Mbps
Port Status LED	Green LED is illuminated when LINK is established to programming software.
Cables	USB Type A to Micro USB Type B: 6ft cable part # USB-CBL-AMICB6 15ft cable part # USB-CBL-AMICB15

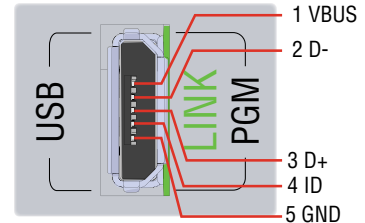
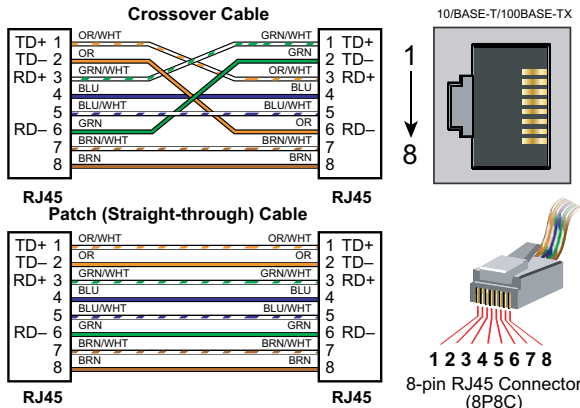

CPU Status Indicators	
PWR	Green LED is illuminated when power is ON
RUN	Green LED is illuminated when CPU is in RUN mode
CPU	Red LED is illuminated during power ON reset, power down, or watch-dog time-out

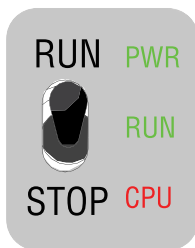

CPU Run/Stop Switch Specifications	
RUN position	Executes user program, run-time edits possible
STOP position	Does not execute user program, normal program load position

Removable Terminal Block Specifications	
Part Number	PCON-KIT
Number of Positions	3 Screw Terminals
Pitch	3.5 mm
Wire Range	28–16 AWG Solid Conductor 28–16 AWG Stranded Conductor
Screw Driver Width	1/8 in (3.175 mm) Maximum
Screw Size	M2
Screw Torque	1.7 lb-in (0.4 N-m)

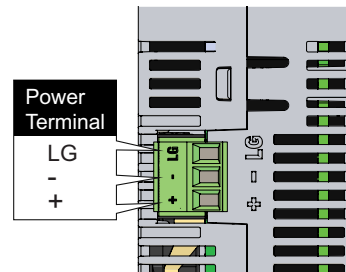

Productivity1000 Power Supplies

All Productivity1000 PLC CPUs require 24VDC input power from either a P1000 power supply or other 24VDC $\pm 2\%$ external power supply.

- P1-01AC: AC Input 85–132 / 170–264 VAC, 16W (power for CPU and up to 8 modules)
- P1-02AC: AC Input 85–132 / 170–264 VAC, 26W (power for CPU and up to 15 modules)
- P1-01DC: DC Input 12–24 VDC, 16W (power for CPU and up to 8 modules)
- The LG and minus terminals on the external power supply connection are internally shorted.
- Use different 24VDC supplies for the CPU and inductive loads to keep the CPU power clean and free of voltage spikes caused by switching inductive loads

General Specifications

Operating Temperature	0° to 60°C (32° to 140°F),
Storage Temperature	-20° to 70°C (-4° to 158°F)
Humidity	5 to 95% (non-condensing)
Altitude	2,000 meters max
Pollution Degree	2
Environmental Air	No corrosive gases permitted
Vibration	IEC60068-2-6 (Test Fc)
Shock	IEC60068-2-27 (Test Ea)
Heat Dissipation	5020mW
Overvoltage Category	II
Enclosure Type	Open Equipment
Module Location	Controller connector on the side of the power supply in a Productivity1000 System.
Weight	130g (4.5 oz)
Agency Approvals	UL 61010-1 and UL 61010-2-201 file E139594, Canada & USA CE (EN 61131-2 EMC, EN 61010-1 and EN 61010-2-201 Safety)*

*See CE Declaration of Conformance for details.

WARNING: To minimize the risk of potential safety problems, you should follow all applicable local and national codes that regulate the installation and operation of your equipment. These codes vary from area to area and it is your responsibility to determine which codes should be followed, and to verify that the equipment, installation, and operation are in compliance with the latest revision of these codes.

Equipment damage or serious injury to personnel can result from the failure to follow all applicable codes and standards. We do not guarantee the products described in this publication are suitable for your particular application, nor do we assume any responsibility for your product design, installation, or operation.

If you have any questions concerning the installation or operation of this equipment, or if you need additional information, please call Technical Support at 770-844-4200.

This publication is based on information that was available at the time it was printed. At AutomationDirect.com® we constantly strive to improve our products and services, so we reserve the right to make changes to the products and/or publications at any time without notice and without any obligation. This publication may also discuss features that may not be available in certain revisions of the product.

CAUTION Battery May Explode If Mistreated.
Do Not Recharge, Disassemble or Dispose Of In Fire

Document Name	Edition/Revision	Date
P1-550-DS	3rd Edition, Rev A3	1/24/2025

Copyright 2018, AutomationDirect.com Incorporated/All Rights Reserved Worldwide