

Input Specifications	
Inputs per Module	8 (sink/source)
Rated Voltage	3.3 – 5 VDC
Operating Voltage Range	3.3 – 5 VDC ±10%
Input Current	6mA @ 3.3 VDC 8mA @ 5VDC
Maximum Input Current	8mA @ 5.5 VDC
Input Impedance	820Ω
Minimum ON Current	1.4 mA
Maximum OFF Current	1mA
ON Voltage Level	> 2.2 VDC
OFF Voltage Level	< 0.8 VDC
OFF to ON, ON to OFF Response	2ms Maximum, 1ms Typical
Status Indicators	Logic Side (8 points)
Commons	2 (4 points/common)

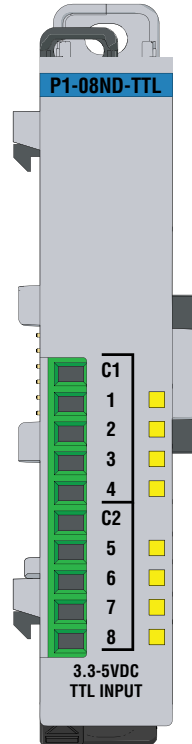

P1-08ND-TTL Input

The P1-08ND-TTL Module provides eight inputs for TTL level devices for use with the Productivity1000 system.

Input Specifications	1
Module Installation	2
QR Code	2
Wiring Options	3
Schematic & Wiring Diagram	3
General Specifications	4
Terminal Block Specifications	4
Warning	4

Terminal Block sold separately, (see wiring options on page 3).
 Warranty: Thirty-day money-back guarantee. Two-year limited replacement (See www.productivity1000.com for details).

Module Installation

QR Code

WARNING: Do not add or remove modules with field power applied.

Step One: With latch in "locked" position, align connectors on the side of each module and stack together. Click indicates lock is engaged.

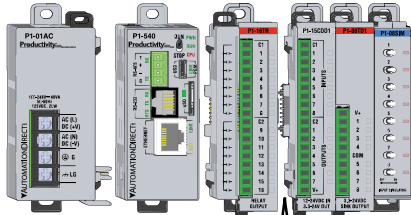

Step Two: Attach field wiring using the removable terminal block or ZIPLink wiring system.

Check all latches are secure after modules are connected.

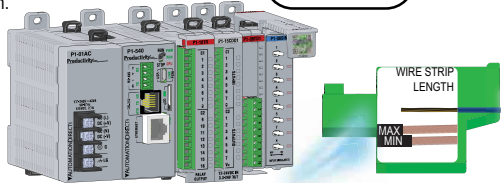

Step Three: To unstack modules, pull locking latch up into the unlocked position and then pull modules apart.

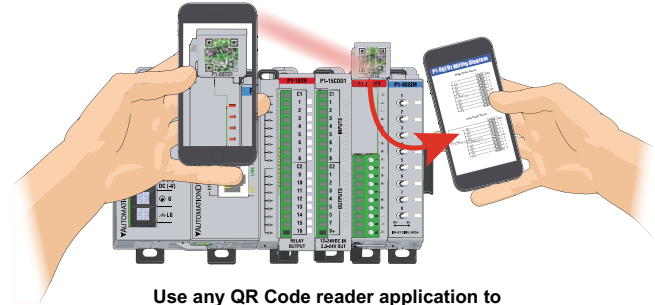
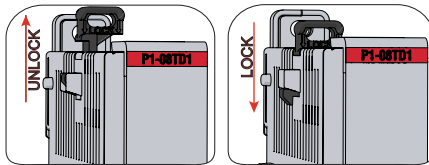

Use any QR Code reader application to display the module's product insert.

P1-08ND-TTL Schematic and Wiring Diagram

Wiring Options

1 ZIPLink Feed Through Modules and Cables¹

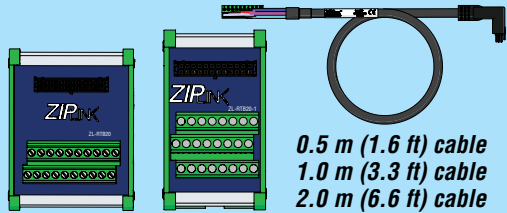

0.5 m (1.6 ft) cable
1.0 m (3.3 ft) cable
2.0 m (6.6 ft) cable



ZL-RTB20
ZL-RTB20-1

ZL-P1-CBL10
ZL-P1-CBL10-1
ZL-P1-CBL10-2

2 Terminal Block with pigtail cable

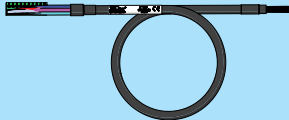

1.0 m (3.3 ft) cable
2.0 m (6.6 ft) cable

ZL-P1-CBL10-1P
ZL-P1-CBL10-2P

3 Screw Terminal Block only

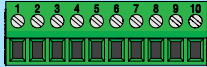

P1-10RTB
(Quantity 1)

4 Spring Clamp Terminal Block only



P1-10RTB-1
(Quantity 1)

5 Accessories²



ZL-RTB-COM
TW-SD-SL-1
TW-SD-MSL-1

1. Cable + ZIPLink Module = Complete System
2. ZL-RTB-COM provides a common connection point for power or ground

Equivalent Input Circuit

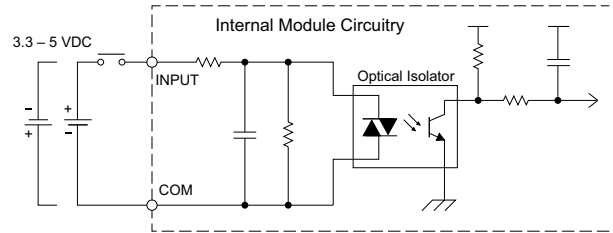

Single Supply

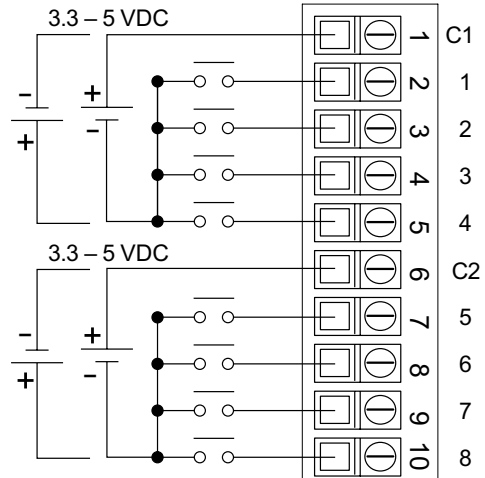

WARNING: To minimize the risk of potential safety problems, you should follow all applicable local and national codes that regulate the installation and operation of your equipment. These codes vary from area to area and it is your responsibility to determine which codes should be followed, and to verify that the equipment, installation, and operation are in compliance with the latest revision of these codes.

Equipment damage or serious injury to personnel can result from the failure to follow all applicable codes and standards. We do not guarantee the products described in this publication are suitable for your particular application, nor do we assume any responsibility for your product design, installation, or operation.

If you have any questions concerning the installation or operation of this equipment, or if you need additional information, please call Technical Support at 770-844-4200.

This publication is based on information that was available at the time it was printed. At AutomationDirect.com® we constantly strive to improve our products and services, so we reserve the right to make changes to the products and/or publications at any time without notice and without any obligation. This publication may also discuss features that may not be available in certain revisions of the product.

Terminal Block Specifications

Part Number	P1-10RTB	P1-10RTB-1
Positions	10 Screw Terminals	10 Spring Clamp Terminals
Wire Range	30–16 AWG (0.051–1.31 mm ²) Solid / Stranded Conductor 3/64 in (1.2 mm) Insulation Max. 1/4 in (6–7 mm) Strip Length	28–16 AWG (0.081–1.31 mm ²) Solid / Stranded Conductor 3/64 in (1.2 mm) Insulation Max. 19/64 in (7–8 mm) Strip Length
Conductors	*USE COPPER CONDUCTORS, 75°C* or equivalent.	
Screw Driver	0.1 in (2.5 mm) Maximum*	
Screw Size	M2	N/A
Screw Torque	2.5 lb-in (0.28 N-m)	N/A

*Recommended Screw Driver TW-SD-MSL-1

General Specifications

Operating Temperature	0° to 60°C (32° to 140°F)
Storage Temperature	-20° to 70°C (-4° to 158°F)
Humidity	5 to 95% (non-condensing)
Altitude	2,000 meters max
Pollution Degree	2
Environmental Air	No corrosive gases permitted
Vibration	IEC60068-2-6 (Test Fc)
Shock	IEC60068-2-27 (Test Ea)
Overvoltage Category	II
Field to Logic Side Isolation	1800VAC applied for 1 second
Insulation Resistance	>10MΩ @ 500VDC
Heat Dissipation	220mW
Enclosure Type	Open Equipment
Module Location	Any I/O position in a Productivity1000 System.
Field Wiring	Use ZIPLink Wiring System or removable terminal block (sold separately). See "Wiring Options" on page 3.
Connector Type (sold separately)	10-Position Removable Terminal Block
Weight	1.9 oz (55g)
Agency Approvals	UL 61010-1 and UL 61010-2-201 File E139594, Canada & USA CE (EN 61131-2 EMC, EN 61010-1 and EN 61010-2-201 Safety)*

*See CE Declaration of Conformance for details.

Document Name	Edition/Revision	Date
P1-08ND-TTL-DS	1st Edition	8/2/2023

Copyright 2018, AutomationDirect.com Incorporated/All Rights Reserved Worldwide