

# OPT2172 – 74

High-Performance Distance Sensors



## Operating Instructions

# Table of Contents

|  |           |
|--|-----------|
| <b>1. General</b>                                | <b>3</b>  |
| 1.1 Information Concerning these Instructions    | 3         |
| 1.2 Explanations of Symbols                      | 3         |
| 1.3 Limitation of Liability                      | 4         |
| 1.4 Copyrights                                   | 4         |
| <b>2. For Your Safety</b>                        | <b>5</b>  |
| 2.1 Use for Intended Purpose                     | 5         |
| 2.2 Use for Other than the Intended Purpose      | 5         |
| 2.3 Personnel Qualifications                     | 6         |
| 2.4 Modification of Products                     | 6         |
| 2.5 General Safety Precautions                   | 6         |
| 2.6 Laser/LED Warnings                           | 6         |
| 2.7 Approvals and protection class               | 6         |
| <b>3. Technical Data</b>                         | <b>7</b>  |
| 3.1 Spot diameter                                | 8         |
| 3.2 Switching Distance Deviation                 | 8         |
| 3.3 Layout                                       | 9         |
| 3.4 Control Panel                                | 10        |
| 3.5 Scope of Delivery                            | 11        |
| <b>4. Transport and Storage</b>                  | <b>11</b> |
| 4.1 Transport                                    | 11        |
| 4.2 Storage                                      | 11        |
| <b>5. Installation and Electrical Connection</b> | <b>12</b> |
| 5.1 Installation                                 | 12        |
| 5.2 Electrical Connection                        | 12        |
| 5.3 Diagnostics                                  | 14        |
| <b>6. Settings</b>                               | <b>16</b> |
| <b>7. Settings via IO-Link</b>                   | <b>18</b> |
| 7.1 Background Teach-In                          | 18        |
| 7.2 Window Teach-In                              | 18        |
| 7.3 Locking                                      | 19        |
| 7.4 Switchable Emitted Light                     | 19        |
| 7.5 External Teach-In                            | 19        |
| 7.7 Test mode                                    | 20        |
| <b>8. Maintenance Instructions</b>               | <b>20</b> |
| <b>9. Proper Disposal</b>                        | <b>20</b> |
| <b>10. Appendix</b>                              | <b>21</b> |
| 10.1 List of Abbreviations                       | 21        |
| 10.2 Change Index, Operating Instructions        | 21        |
| 10.3 EU Declaration of Conformity                | 21        |

# 1. General

## 1.1 Information Concerning these Instructions

- These instructions apply to the product with ID code OPT2172 – 74.
- They make it possible to use the product safely and efficiently.
- These instructions are an integral part of the product and must be kept on hand for the entire duration of its service life.
- Local accident prevention regulations and national work safety regulations must be complied with as well.
- The product is subject to further technical development, and thus the information contained in these operating instructions may also be subject to change. The current version can be found at [www.automationdirect.com](http://www.automationdirect.com) in the product's separate download area.



### NOTE!

The operating instructions must be read carefully before using the product and must be kept on hand for later reference.

## 1.2 Explanations of Symbols

- Safety precautions and warnings are emphasized by means of symbols and attention-getting words
- Safe use of the product is only possible if these safety precautions and warnings are adhered to

The safety precautions and warnings are laid out in accordance with the following principle:



---

### Attention-Getting Word! Type and Source of Danger!

Possible consequences in the event that the hazard is disregarded.

- Measures for averting the hazard.

---

The meanings of the attention-getting words, as well as the scope of the associated hazards, are listed below.



---

### DANGER!

This word indicates a hazard with a high degree of risk which, if not avoided, results in death or severe injury.

---



---

### WARNING!

This word indicates a hazard with a medium degree of risk which, if not avoided, may result in death or severe injury.

---



---

### CAUTION!

This word indicates a hazard with a low degree of risk which, if not avoided, may result in minor or moderate injury.

---



---

### ATTENTION!

This word draws attention to a potentially hazardous situation which, if not avoided, may result in property damage.

---



---

### NOTE!

A note draws attention to useful tips and suggestions, as well as information regarding efficient, error-free use.

---

### 1.3 Limitation of Liability

- The product has been developed in consideration of the current state-of-the-art and applicable standards and guidelines. Subject to change without notice.
- A valid declaration of conformity can be accessed at [www.automationdirect.com](http://www.automationdirect.com) in the product's separate download area.
- wenglor sensoric elektronische Geräte GmbH (hereinafter referred to as "wenglor") excludes all liability in the event of:
  - Non-compliance with the instructions
  - Use of the product for purposes other than those intended
  - Use by untrained personnel
  - Use of unapproved replacement parts
  - Unapproved modification of products
- These operating instructions do not include any guarantees from wenglor with regard to the described procedures or specific product characteristics.
- wenglor assumes no liability for printing errors or other inaccuracies contained in these operating instructions, unless wenglor was verifiably aware of such errors at the point in time at which the operating instructions were prepared.

### 1.4 Copyrights

- The contents of these instructions are protected by copyright law.
- All rights are reserved by wenglor.
- Commercial reproduction or any other commercial use of the provided content and information, in particular graphics and images, is not permitted without previous written consent from wenglor.

## 2. For Your Safety

### 2.1 Use for Intended Purpose

The product is based on the following functional principle:

#### High-Performance Distance Sensor

High-performance distance sensors, which function in accordance with the transit time measuring principle, determine the distance between the sensor and the object by measuring elapsed time from emission to return of the light beam. These sensors have a large working range and thus detect objects over considerable distances. Selected sensors are distinguished by WinTec (wenglor interference free technology). This technology allows black or shiny surfaces to be reliably detected even in extremely inclined positions. It is possible to mount several sensors next to or across from each other without them influencing each other.

#### This product can be used in the following industry sectors:

- Special machinery manufacturing
- Heavy machinery manufacturing
- Logistics
- Automotive industry
- Food industry
- Packaging industry
- Pharmaceuticals industry
- Plastics industry
- Woodworking industry
- Consumer goods industry
- Paper industry
- Electronics industry
- Glass industry
- Steel industry
- Aviation industry
- Chemicals industry
- Alternative energy
- Raw materials extraction

### 2.2 Use for Other than the Intended Purpose

- Not a safety component in accordance with 2006/42/EC (Machinery Directive)
- The product is not suitable for use in potentially explosive atmospheres.
- The product may only be used with accessories supplied or approved by wenglor, or combined with approved products. A list of approved accessories and combination products can be accessed at [www.automationdirect.com](http://www.automationdirect.com) on the product detail page.

---

#### **DANGER!**



#### **Risk of personal injury or property damage in case of use for other than the intended purpose!**

- Use for other than the intended purpose may lead to hazardous situations.
- Observe instructions regarding use for intended purpose.
-

## 2.3 Personnel Qualifications

- Suitable technical training is a prerequisite.
- In-house electronics training is required.
- Trained personnel must have uninterrupted access to the operating instructions.



### **DANGER!**

**Risk of personal injury or property damage in case of incorrect initial start-up and maintenance!**

Personal injury and damage to equipment may occur.

- Adequate training and qualification of personnel.
- 

## 2.4 Modification of Products



### **DANGER!**

**Risk of personal injury or property damage if the product is modified!**

Personal injury and damage to equipment may occur. Non-observance may result in loss of the CE marking and the guarantee may be rendered null and void.

- Modification of the product is impermissible.
- 

## 2.5 General Safety Precautions



### **NOTE!**

- These instructions are an integral part of the product and must be kept on hand for the entire duration of its service life.
- In the event of possible changes, the respectively current version of the operating instructions can be accessed at [www.automationdirect.com](http://www.automationdirect.com) in the product's download area.
- Read the operating instructions carefully before using the product.
- Protect the sensor against contamination and mechanical influences.

## 2.6 Laser/LED Warnings

The respective laser class or LED group is listed in the product's technical data.



**Laser Class 1 (EN 60825-1)**

Applicable standards and safety regulations must be observed.

---

## 2.7 Approvals and protection class



### 3. Technical Data

| <b>Optical Data</b>                         |               |
|---|---------------|
| Working range                               | 0...1000 mm   |
| Setting range                               | 100...1000 mm |
| Switching hysteresis                        | < 20 mm       |
| Light source                                | Laser (red)   |
| Wavelength                                  | 680 nm        |
| Service life (ambient temp. = +25° C)       | 100000 h      |
| Laser class (EN 60825-1)                    | 1             |
| Beam Divergence                             | < 16 mrad     |
| Max. permissible ambient light              | 10000 Lux     |
| Spot diameter                               | see Table 1   |
| Triple Dot Laser                            | yes           |
| <b>Electrical Data</b>                      |               |
| Supply power                                | 10...30 V DC  |
| Current Consumption (U <sub>b</sub> = 24 V) | < 30 mA       |
| Temperature range                           | -40...50 °C   |
| Switching output voltage drop               | < 2,5 V       |
| Switching output switching current          | 100 mA        |
| Short-circuit protection                    | yes           |
| Reverse polarity protected                  | yes           |
| Overload-proof                              | yes           |
| Protection class                            | III           |
| <b>Mechanical Data</b>                      |               |
| Housing material                            | Plastic       |
| Lens cover                                  | PMMA          |
| Degree of protection                        | IP67          |

| Technical Data                             | Order No.      |  |                                       |
|--|----------------|--|---------------------------------------|
|  | OPT2172        | OPT2173                                | OPT2174                               |
| Mounting technology no.                    | 223            |  |                                       |
| Connection                                 | M8×1, 4-pin    | Cable 200 mm with plug<br>M12×1, 4-pin | Cable 200 mm with plug<br>M8×1, 4-pin |
| Interface                                  | IO-Link V1.1   |  |                                       |
| Number of switching outputs                | 2 programmable |  |                                       |
| Setting Method                             | Teach-in       |  |                                       |
| MTTFd (EN ISO 13849-1)                     | 1021,76 a      |  |                                       |
| Supply power with IO-Link                  | 18...30 V      |  |                                       |
| Switching Frequency                        | 500 Hz         |  |                                       |
| Response Time                              | 1 ms           |  |                                       |
| Temperature drift<br>(-40 °C < Tu < 50 °C) | < 3 %          |  |                                       |
| Temperature drift<br>(-10 °C < Tu < 50 °C) | < 2 %          |  |                                       |
| Output function                            | PNP NC, PNP NO |  | ×                                     |
|  | NPN NC, NPN NO |  | —                                     |

### 3.1 Spot diameter

|                  |        |        |         |
|------------------|--------|--------|---------|
| Working distance | 100 mm | 500 mm | 1000 mm |
| Spot diameter    | 4 mm   | 7 mm   | 15 mm   |

Table 1

### 3.2 Switching Distance Deviation

OPT2172, OPT2173, OPT2174

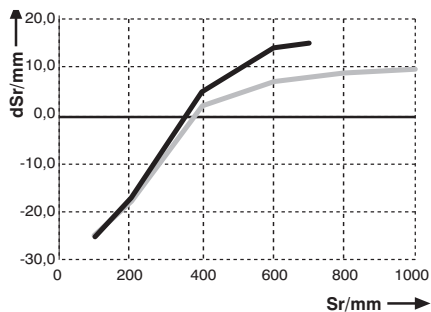

Typical characteristic curve based on Kodak white (90% remission)

Sr = switching distance

dSr = change in switching distance

Black, 6 % remission

Gray, 18 % remission



### 3.3 Layout

OPT2172

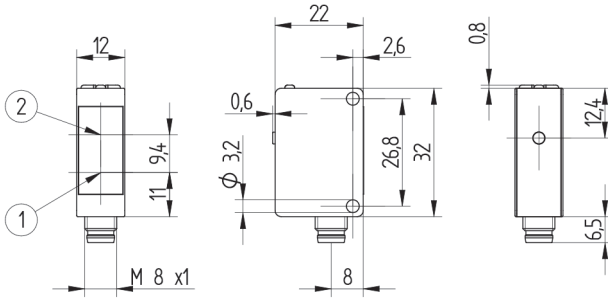

OPT2173

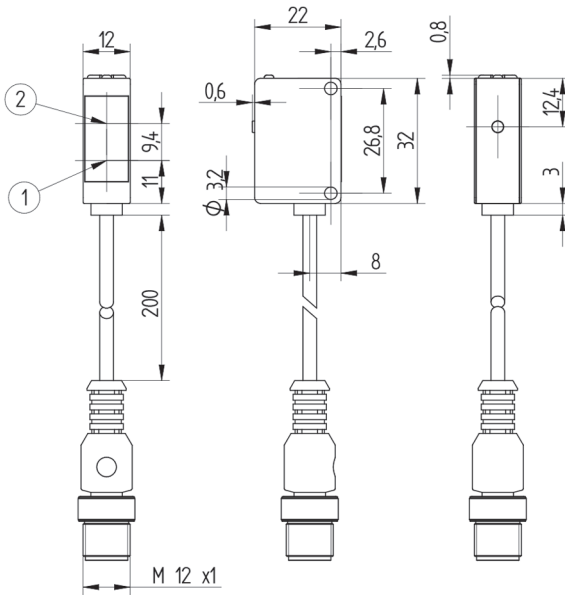

## OPT2174

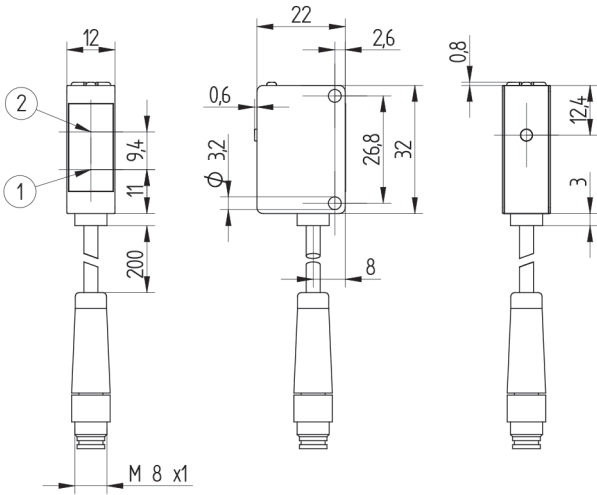

1 = receiver diode

2 = emitter diode

M3 screw = 0,5 Nm

Dimensions specified in mm (1 mm = 0.03937")

## 3.4 Control Panel

### OPT2172-74

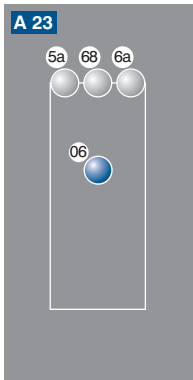

06 = teach-in key

5a = switching status display, A1

6a = switching status display, A2

68 = supply power indicator

### 3.5 Scope of Delivery

- Sensor
- Commissioning Instructions
- Mounting-Set 01

## 4. Transport and Storage

### 4.1 Transport

Upon receipt of shipment, the goods must be inspected for damage in transit. In the case of damage, conditionally accept the package and notify the manufacturer of the damage. Then return the device, making reference to damage in transit.

### 4.2 Storage

**The following points must be taken into condition with regard to storage:**

- Do not store the product outdoors.
- Store the product in a dry, dust-free place.
- Protect the product against mechanical impacts.
- Protect the product against exposure to direct sunlight.



**ATTENTION!**

**Risk of property damage in case of improper storage!**

The product may be damaged.

- Storage instructions must be complied with.
-

## 5. Installation and Electrical Connection

### 5.1 Installation

- Protect the product from contamination during installation.
- Observe all applicable electrical and mechanical regulations, standards, and safety rules.
- Protect the product against mechanical influences.
- Make sure that the sensor is mounted in a mechanically secure fashion.
- Specified torque values must be complied with (see section “3.4 Layout”, page 9).



#### ATTENTION!

##### Risk of property damage in case of improper installation!

The product may be damaged.

- Installation instructions must be complied with.



#### CAUTION!

##### Risk of personal injury or property damage during installation!

Personal injury and damage to the product may occur.

- A safe installation environment must be assured.

### 5.2 Electrical Connection

Connect the sensor to supply voltage (see section “3. Technical Data”, page 7).

#### OPT2172 – 74

223

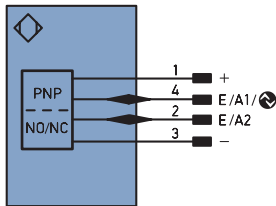

## Legend

|  |  |
|--|--|
| +  | Supply Voltage +                           |
| -  | Supply Voltage 0 V                         |
| ~  | Supply Voltage (AC Voltage)                |
| A  | Switching Output (NO)                      |
| Ā  | Switching Output (NC)                      |
| V  | Contamination/Error Output (NO)            |
| ∇  | Contamination/Error Output (NC)            |
| E  | Input (analog or digital)                  |
| T  | Teach Input                                |
| Z  | Time Delay (activation)                    |
| S  | Shielding                                  |
| RxD  | Interface Receive Path                     |
| TxD  | Interface Send Path                        |
| RDY  | Ready                                      |
| GND  | Ground                                     |
| CL   | Clock                                      |
| E/A  | Output/Input programmable                  |
|  | <b>IO-Link</b>                             |
| PoE  | Power over Ethernet                        |
| IN   | Safety Input                               |
| oSSD   | Safety Output                              |
| Signal   | Signal Output                              |
| BI_D +/-   | Ethernet Gigabit bidirect. data line (A-D) |
| EN <sub>0RS422</sub>   | Encoder 0-pulse 0-0̄ (TTL)                 |
| PT   | Platinum measuring resistor                |
| nc   | not connected                              |
| U  | Test Input                                 |
| ū  | Test Input inverted                        |
| W  | Trigger Input                              |
| W-   | Ground for the Trigger Input               |
| O  | Analog Output                              |
| O-   | Ground for the Analog Output               |
| BZ   | Block Discharge                            |
| AWV  | Valve Output                               |
| a  | Valve Control Output +                     |
| b  | Valve Control Output 0 V                   |
| SY   | Synchronization                            |
| SY-  | Ground for the Synchronization             |
| E+   | Receiver-Line                              |
| S+   | Emitter-Line                               |
| ±  | Grounding                                  |
| SnR  | Switching Distance Reduction               |
| Rx+/-  | Ethernet Receive Path                      |
| Tx+/-  | Ethernet Send Path                         |
| B <sub>us</sub>  | Interfaces-Bus A(+)/B(-)                   |
| La   | Emitted Light disengageable                |
| Mag  | Magnet activation                          |
| RES  | Input confirmation                         |
| EDM  | Contactor Monitoring                       |
| EN <sub>0RS422</sub>   | Encoder A/Ā (TTL)                          |
| EN <sub>BRS422</sub>   | Encoder B/B̄ (TTL)                         |
| EN <sub>A</sub>  | Encoder A                                  |
| EN <sub>B</sub>  | Encoder B                                  |
| A <sub>MIN</sub>   | Digital output MIN                         |
| A <sub>MAX</sub>   | Digital output MAX                         |
| A <sub>OK</sub>  | Digital output OK                          |
| SY <sub>In</sub>   | Synchronization In                         |
| SY <sub>OUT</sub>  | Synchronization OUT                        |
| O <sub>L</sub> T   | Brightness output                          |
| M  | Maintenance                                |
| rsv  | reserved                                   |
| Wire Colors according to IEC 60757   |  |
| BK   | Black                                      |
| BN   | Brown                                      |
| RD   | Red  |
| OG   | Orange                                     |
| YE   | Yellow                                     |
| GN   | Green                                      |
| BU   | Blue                                       |
| VT   | Violet                                     |
| GY   | Grey                                       |
| WH   | White                                      |
| PK   | Pink                                       |
| GNYE   | Green/Yellow                               |

## DANGER!



### Risk of personal injury or property damage due to electric current!

Voltage conducting parts may cause personal injury or damage to equipment.

- The electric device may only be connected by appropriately qualified personnel.

## 5.3 Diagnostics

### P1KY001–004

#### Causes for Triggering the Error Messages (blinking LED at approx. 2,5 Hz):

| Display LED                           | Diagnosis/Cause          | Elimination  |
|---------------------------------------|--------------------------|--|
| Continuous blinking at approx. 2.5 Hz | Contamination            | Carefully clean the optic cover with a cloth.  |
|                                       | Unreliable working range | <ul style="list-style-type: none"><li>• Increase the sensor's switching distance.</li><li>• Reduce distance between sensor and object.</li></ul> |

### P1KY005–007 und P1KY012–014

#### Causes for Triggering the Error Messages (A1/A2 Continuous blinking LED):

| Display LED                           | Diagnosis/Cause          | Elimination  |
|---------------------------------------|--------------------------|--|
| Continuous blinking at approx. 2.5 Hz | Contamination            | Carefully clean the optic cover with a cloth.  |
|                                       | Unreliable working range | <ul style="list-style-type: none"><li>• Increase the sensor's switching distance.</li><li>• Reduce distance between sensor and object.</li></ul> |
| Continuous blinking at approx. 5 Hz   | Hardware error           | Replace the sensor.  |

## Contamination Warning Flowcharts

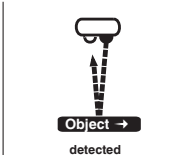
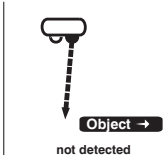
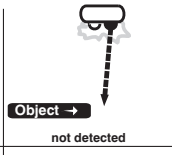
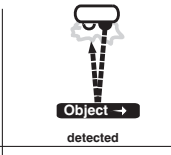
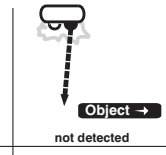
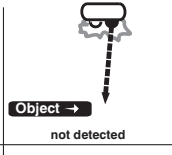
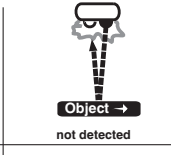
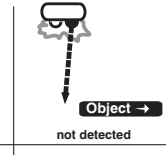
| Transmit Time Sensor           |   | no contamination  |   |  |
|--------------------------------|---|---|---|--|
|                                |  |  |  |  |
| Object                         | not detected  | detected  | not detected  |  |
| Switching Status Indicator     | off <input type="radio"/>   | on <input checked="" type="radio"/>   | off <input type="radio"/>   |  |
| <b>beginning contamination</b> |   |   |   |  |
|                                |  |  |  |  |
| Object                         | not detected  | detected  | not detected  |  |
| Switching Status Indicator     | off <input type="radio"/>   | blinking <input checked="" type="radio"/>   | off <input type="radio"/>   |  |
| <b>advanced contamination</b>  |   |   |   |  |
|                                |  |  |  |  |
| Object                         | not detected  | not detected  | not detected  |  |
| Switching Status Indicator     | off <input type="radio"/>   | off <input type="radio"/>   | off <input type="radio"/>   |  |

### Required action in case of fault:

#### NOTE!

- Shut down the machine.
- Analyze and eliminate the cause of error with the help of the diagnostics information.
- If the error cannot be eliminated, please contact AutomationDirect's support department.
- Do not operate in case of indeterminate malfunctioning.
- The machine must be shut down if the error cannot be unequivocally clarified or reliably eliminated.



#### DANGER!

#### Risk of personal injury or property damage in case of non-compliance!

- The system's safety function is disabled. Personal injury and damage to equipment.
- Required action as specified in case of fault.

## 6. Settings

### **Object Detection Directly in Front of the Background or Underlying Surface**

- Adjust and securely mount the sensor in accordance with the installation instructions making sure that the object lies within the beam emitted by the sensor.
- Remove the object and slowly turn the potentiometer back down until the sensor is deactivated. The background or the underlying surface is now suppressed.
- Place the object back into the beam emitted by the sensor and check to determine whether or not the sensor is activated again.

### **Detection of Objects Without Interfering Background**

- Adjust and securely mount the sensor in accordance with the installation instructions making sure that the object lies within the beam emitted by the sensor.
- Turn the potentiometer down until the sensor is deactivated and then turn it back up until the sensor is once again activated – if necessary turn it up a bit more in order to enhance switching reliability.



## OPT2172 – 74 (Sensors with Teach-in)

The switching distance to the object can be taught in for both outputs by pressing the teach-in key on the sensor (foreground teach-in).

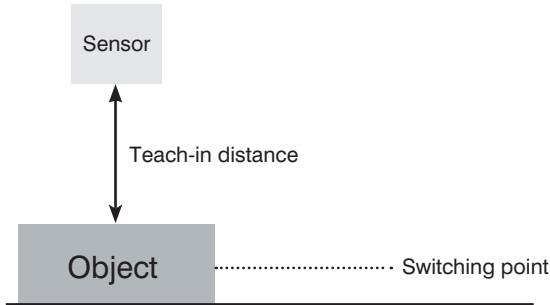

### Foreground Teach-In for Switching Output 1

1. Mount the sensor in accordance with the mounting instructions.
2. Position the object in front of the sensor.
3. Press and hold the teach-in key until switching status indicator LED A1 starts blinking.
4. Release the teach-in key after 2 seconds.
5. The distance is taught in and the LED output 1 lights up in order to confirm successful teach-in.

### Foreground Teach-In for Switching Output 2

1. Mount the sensor in accordance with the mounting instructions.
2. Position the object in front of the sensor.
3. Press and hold the teach-in key until switching status indicator LED A2 starts blinking.
4. Release the teach-in key after 5 seconds.
5. The distance is taught in and the LED output 2 lights up in order to confirm successful teach-in.

#### NOTE!



If teach-in is conducted without an object or if the object is too far from the sensor, switching distance is set to the end of the setting range and LED A1/A2 LED blinks at a rate of 8 Hz. The same applies to objects which are too close, but in this case switching distance is set to the beginning of the setting range.

## 7. Settings via IO-Link

### OPT2172 – 74 (Sensors with Teach-in)

Further settings can be entered to the sensor via the IO-Link interface.

In addition to foreground teach-in (default setting), there's also a background teach-in option for both outputs.

Additionally, there's also a window teach-in option for both outputs.

Process and parameters data, as well as the interface protocol and the IO-Link, can be found at

[www.automationdirect.com](http://www.automationdirect.com) in the product's separate download area.

### 7.1 Background Teach-In

1. Mount the sensor in accordance with the mounting instructions.
2. Align the sensor to the background.
3. Configure or teach-in the switching output / the switching output function via IO-Link.
4. The sensor is switched as soon as an object is located between the background and the sensor.

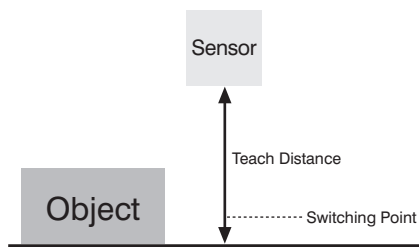

### 7.2 Window Teach-In

1. Mount the sensor in accordance with the mounting instructions.
2. Align the sensor to the background.
3. If necessary, adjust the window with the near and far switching points.
4. The sensor is switched when an object is located between the two switching points.

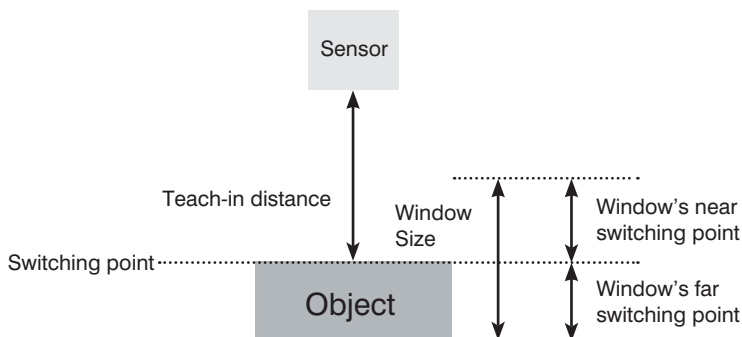

If the teach-in mode is selected, the switching point can be taught in by pressing the teach-in key.

### 7.3 Locking

If 18 to 30 V DC is continuously applied to the teach-in input, the teach-in key is locked and protected against inadvertent changes.

1. Change the A1/A2 pin function to external teach-in.
2. Permanently connect pin A2 to voltage within a range of 18 to 30 V DC.
3. The teach-in key is deactivated.

### 7.4 Switchable Emitted Light

Emitted light from the sensor can be switched off by means of an IO-Link parameter. Beyond this, the sensors' inputs can be programmed via IO-Link so that the "switchable emitted light" function can also be activated by applying 24 V to the respective input.

### 7.5 External Teach-In

Teach in output A1 via the teach-in input.

1. Set the A2 pin function to external teach-in.
2. Apply 24 V to pin A2 for at least 1 second, but for no more than 4 seconds.
3. As soon as voltage drops at the input, A1 is taught in.

#### NOTE!



Please note that during external teach-in via one of the two configurable output pins, both independent switching points are stored to the sensor and can be read out at any time via the process data using IO-Link. If both outputs need to be evaluated via the pins, the previously configured teach-in input must be configured once again as an output.

### 7.6 Error output

The error output is switched in the following cases:

- Signal from object too weak
- Incorrect installation
- The object is located outside of the working range.

## 7.7 Test mode

### OPT2172 – 74 (Sensors with Teach-in)

A test mode can be activated for the sensors via the parameter settings. This mode simulates sensor operation, for example switching of the outputs or entry of a measured value although the sensor hasn't detected an actual object. The application can be run in the test mode with correctly switching outputs and display LEDs.

## 8. Maintenance Instructions

### NOTE!



- This wenglor sensor is maintenance-free.
- Cleaning and inspection of the plug connections at regular intervals are advisable.
- Do not clean the sensor with solvents or cleansers which could damage the product.
- The product must be protected against contamination during initial start-up.

## 9. Proper Disposal

wenglor sensoric GmbH does not accept the return of unusable or irreparable products. Respectively valid national waste disposal regulations apply to product disposal.

## 10. Appendix

### 10.1 List of Abbreviations

| Abbreviation | Meaning                        |
|--------------|--------------------------------|
| IODD         | IO Device Description          |
| MTTFd        | Mean Time to Dangerous Failure |

### 10.2 Change Index, Operating Instructions

| Version | Date       | Description/Change                            |
|---------|------------|---|
| 1.0.0   | 16.11.2020 | Initial version of the operating instructions |
|         |            |   |

### 10.3 EU Declaration of Conformity

The EU declaration of conformity can be found on our website at [www.automationdirect.com](http://www.automationdirect.com) in the product's download area.