

Appendix A

Example Programs

In This Chapter. . . .

- Installing Example Programs
 - Selecting and Connecting Cables
 - Running Example Programs
 - Program Worksheets
-

Understanding the Example Programs

One of the best ways to learn how to use the OP-panel is to load the example programs which are on the supplied diskette, and run the program for your PLC. A Cement Kiln System is used to demonstrate the ladder logic required to support the various OP-panel features. The program provides ladder logic which demonstrates controlling pushbuttons, lamps, messages and menu operations. Use an understanding of this example program to help develop programs for your own applications.

Follow the instructions in this chapter for installing and running the example programs.

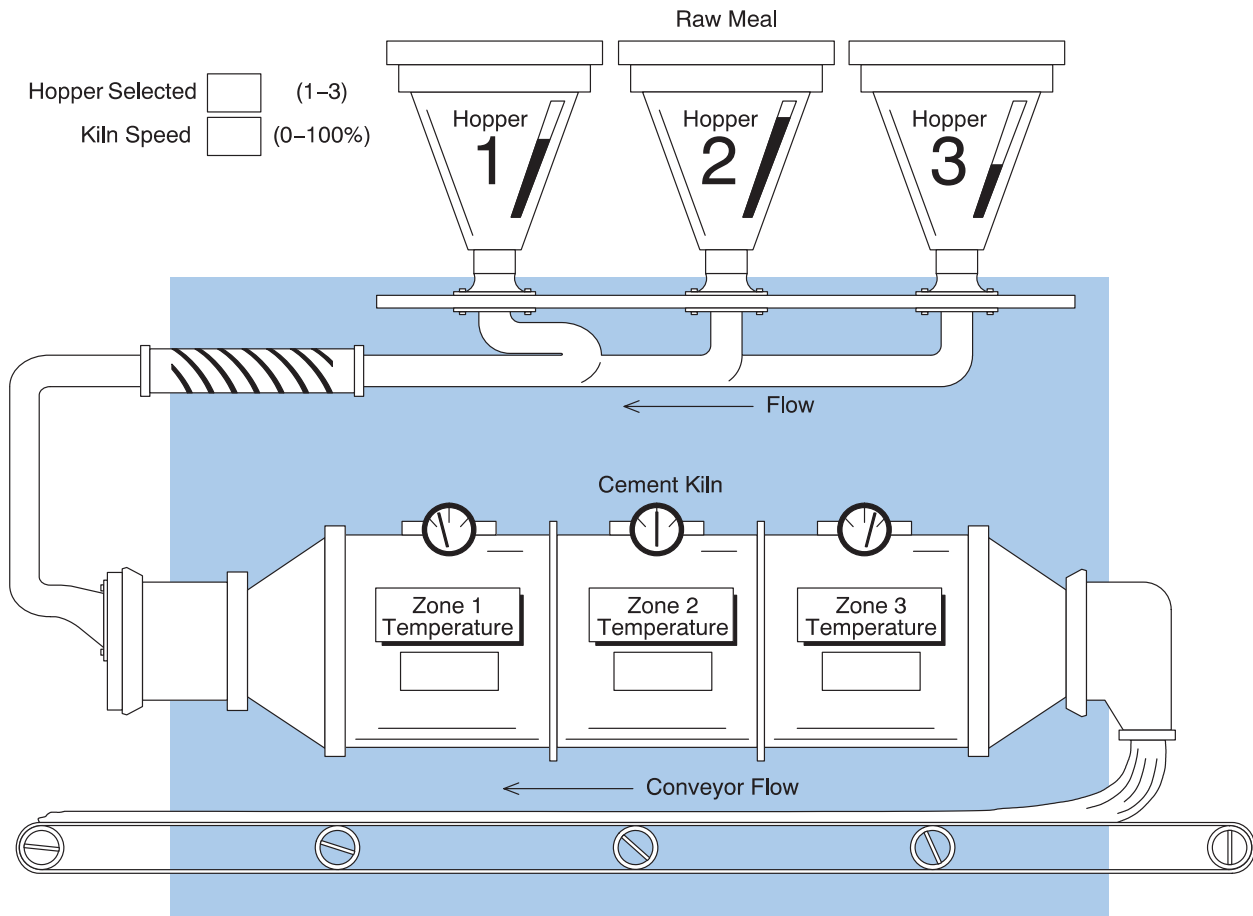

Software Requirements

The example programs require that you have two software packages loaded on your personal computer:

- **DirectSOFT** programming software, and
- **OP-WINEDIT (OptiMate Editor)** configuration software.

If you do not have these software packages, obtain and install them on your personal computer using the instructions in their user manuals.

Once you have both programs installed on your personal computer you are ready to use the following step-by-step instructions for installing and using the example programs.

9 Steps to Using the Example Programs

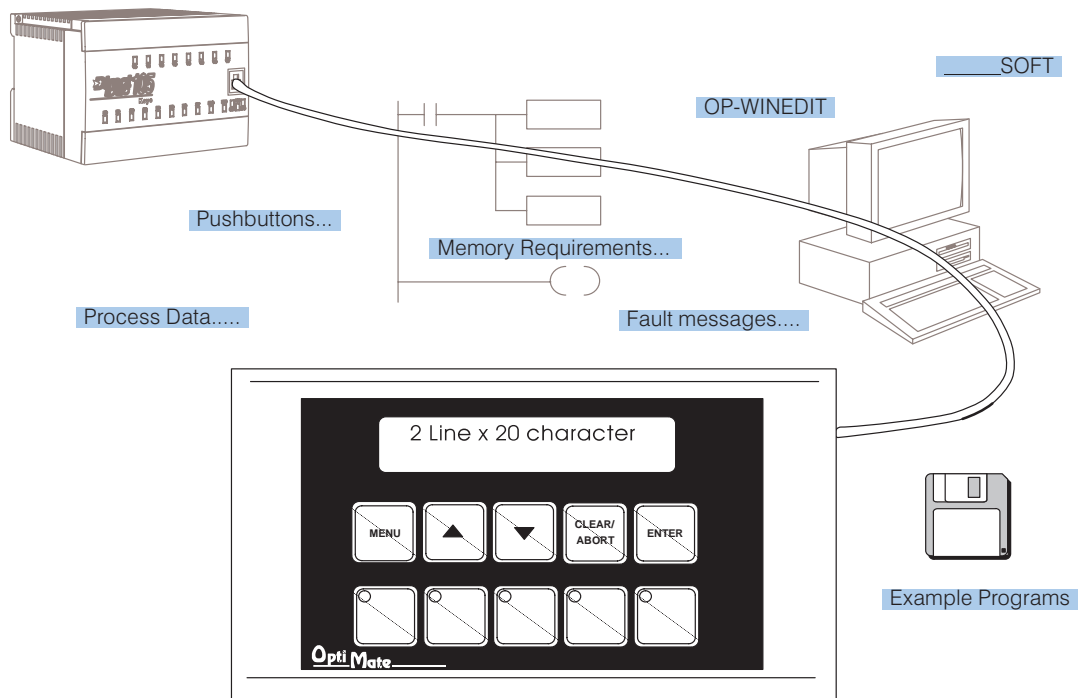

Step 1: Power Supply Connections

An external power supply should be used to power the Optimization unit. The power supply must supply a voltage of 8 to 30 VDC. Connect the power supply using the supplied terminal block connector. The connector is keyed to prevent reversing the polarity. Pin 1 is the positive connection (8 to 30VDC), while pin 2 is the common (0VDC) or ground connection.

Use 18–24 AWG conductor wire and connect the power supply to the supplied connector block as follows: Connect the positive (+8 to 30 VDC) lead to terminal 1, and connect the common ground (0V) lead to terminal 2.

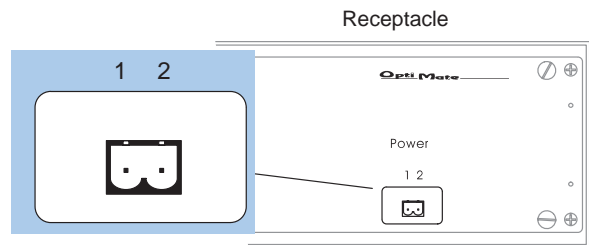
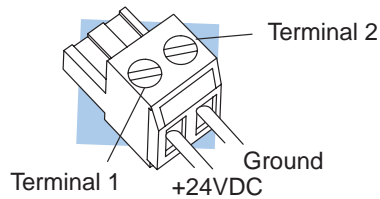

Plug the terminal block connector into Power receptacle located on the back side of the panel.

Step 1A:
Multi-Panel Power
Supply
Connections
(Optional)

In multi-panel applications, if using separate power supplies, make sure the electrical ground commons do not have a great potential difference. When using a *single* power supply in a *multi-panel* application, the power supply must maintain the specified voltage and current consumption for each of the individual units under all conditions (including power-up). See individual panel power requirements.

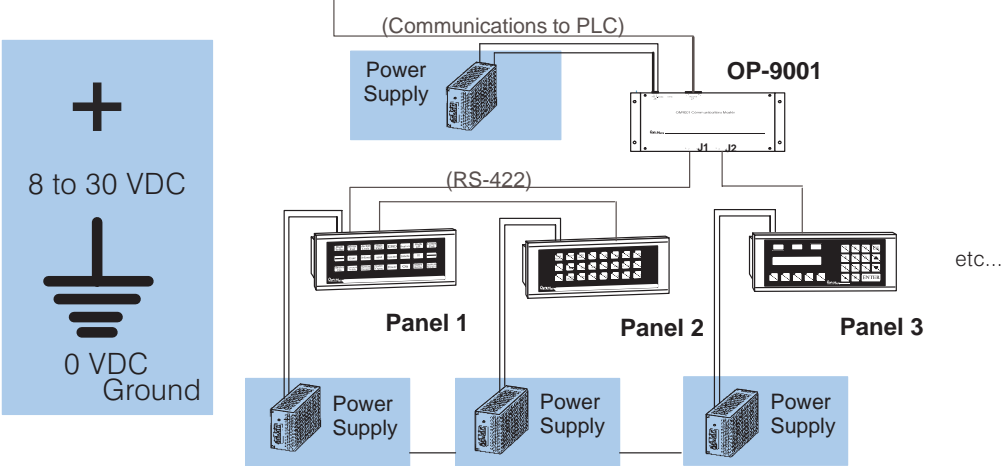

**Step 2: Setting the
OP-Panel
PGM/RUN DIP
Switch to PGM**

You may generate your OP-panel configuration off-line. To download your configuration, the PGM/RUN DIP switch located on the back of the OP-panel must be set to PGM (ON). The TERM switch should remain off.

NOTE: You must cycle power to the panel (turn power off, set DIP switch, and turn power back on) to activate the new switch settings.

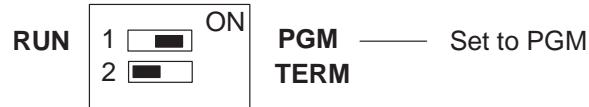

For multi-panel configurations, see the section titled OP-9001 Multi-Panel Configurations towards the end of this chapter.

**Step 3: Selecting
Cables**

Depending on which PLC you are using, you may require as many as three cables to use the example programs:

- An OP-ACBL-1 configuration cable to connect your personal computer to the OP-panel to load the configuration program into the panel. *All panels* use the OP-ACBL-1 for the configuration cable. This cable is also used to connect an OP-panel to an Allen-Bradley SLC 500 CPU.
- A cable to connect your personal computer to the PLC to load the **DirectSOFT** example ladder programs into your PLC. See the **DirectSOFT** user manual for help in selecting the proper cable to use with your PLC.
- A cable to connect the OP-panel to the PLC. Use the information on the next two pages to select the proper cable to use with your PLC.

Choosing Your Connecting Cables

Depending on which PLC you are using, you may require as many as two cables. Here are the requirements:

- **OP-ACBL-1:** *all* units require this cable for configuration. This is a 9-pin female to 15-pin male cable that connects your personal computer to the OP-panel. This cable is also used to connect an OP-panel to the Allen-Bradley SLC 500 CPUs listed.
- **CPU Cables:** You will also need the appropriate cable to connect your CPU to the OP-panel. Use the chart shown to the right to choose the correct communications cable.

OP-9001 Cable Connectors

If you're planning to use multiple panels and an OP-9001, then you will need to build your own custom cables. Since the proper cable choice really depends on your application, we offer the following connectors.

- **OP-CMCON-1** — pack of 4 ribbon cable connectors.
- **OP-CMCON-2** — pack of 4 solder-type connectors.
- **OP-CMCON-3** — pack of 2 D-shell connectors with screw terminals for use with OP-9001 & multiple OP-panels.
- **OP-PSCON** — pack of 4 power supply block connectors.

For electrically noisy environments, we recommend an individually paired and shielded cable, such as Belden 9729 or equivalent. This type of cable requires the solder-type or D-shell with screw terminal connectors. For distance of 30 feet or less, you can use ribbon cable. For ribbon cable, we recommend Belden 9L28015 or 3M 3365/15.

OptiMate Cables			
Family	CPU (or other device)	Port	Cable
DirectLOGIC-DL105	DL130	Only port	OP-2CBL
DirectLOGIC-DL205	DL230	Only port	OP-2CBL
		DL240	Top port
	DL250	Bottom port	OP-2CBL
		Top port	OP-2CBL
D2-DCM (module)	Only port	OP-4CBL-2	
DirectLOGIC-DL305	DL330	Requires DCU*	OP-4CBL-2
	DL330P	Requires DCU*	OP-4CBL-2
	DL340	Top port	OP-3CBL
		Bottom port	OP-3CBL
	DL350	Top port	OP-2CBL
Bottom port		OP-4CBL-2	
DirectLOGIC-DL405	DL430	Top port (15-pin)	OP-4CBL-1
		Bottom port (25-pin)	OP-4CBL-2
	DL440**	Top port	OP-4CBL-1
		Bottom port	OP-4CBL-2
	DL450	Phone Jack	OP-2CBL
		Top port (15-pin)	OP-4CBL-1
		Bottom port (25-pin)	OP-4CBL-2
	D4-DCM (module)	Only port	OP-4CBL-2
Slice I/O panels	Only port	OP-4CBL-1	
GE® Series 1	IC610CPU105/106	Requires DCU*	OP-4CBL-2
GE® Series- 90/30	All Models (311-351)	RS232, RS422 Serial Port	OP-GCBL-1
GE® Fanuc-Series 90 Micro	All Models	RS232, RS422 Serial Port	OP-GCBL-1
MODICON	ModBus	RJ45 port	OP-MCBL-1
TI305™ / SIMATIC® TI305-	325-07, PPX:325-07	Requires DCU*	OP-4CBL-2
		Requires DCU*	OP-4CBL-2
	325S-07 (or 325 w/ Stage Kt)	Requires DCU*	OP-4CBL-2
	330S-37, PPX:330S-37	Requires DCU*	OP-4CBL-2
	335-37, PPX:335-37	Phone Jacks	OP-3CBL
If DCU is used*		OP-4CBL-2	
TI405- / SIMATIC® TI405-	425-CPU, PPX:425-CPU **	Only port	OP-4CBL-1
		Top port (15-pin)	OP-4CBL-1
	PPX:430-CPU	Bottom port (25-pin)	OP-4CBL-2
		435-CPU, PPX:435-CPU **	Top port (15-pin)
	Smart Slice- I/O panels	Only port	OP-4CBL-1
A-B SLC 500	5/03, 5/04	Bottom port	OP-ACBL-1
		Only port	OP-ACBL-2
A-B	MicroLogix	Only port	OP-ACBL-2

* — requires RS232 Data Communications Unit (D3-232-DCU)

** — also DC versions

Connecting Cable Details

Connecting Cable The OP-620 connecting cable may vary depending on which CPU you use. Refer to the previous page to select the proper cable for connecting to your PLC.

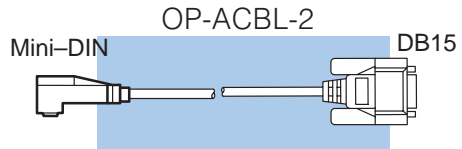
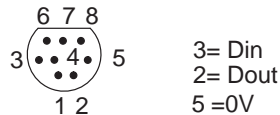
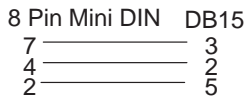
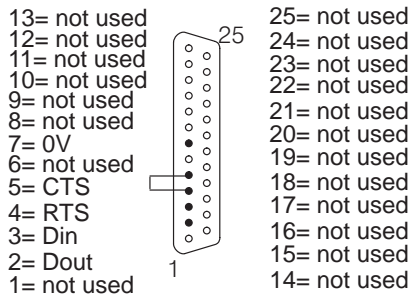
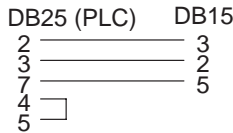
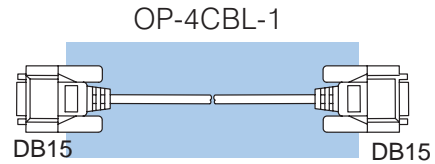
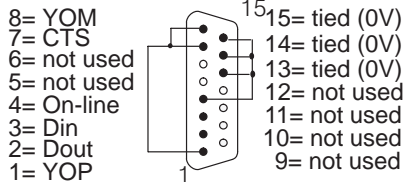
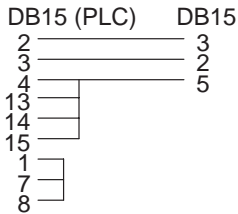
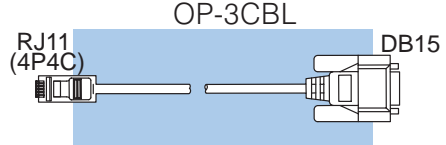
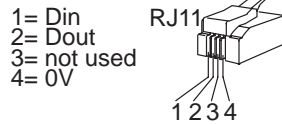
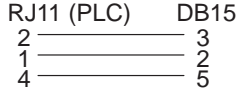
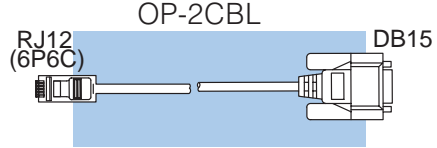
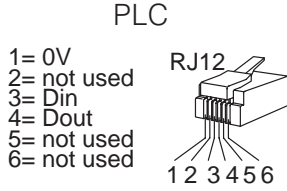
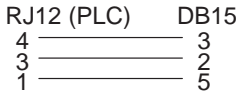

RS-422 Pinout	
PLC	Panel
Din +	11 = Dout+
Din -	12 = Dout-
Dout +	9 = Din +
Dout -	10 = Din-
0V	5 = 0V
RTS+	
CTS+	
RTS-	
CTS-	

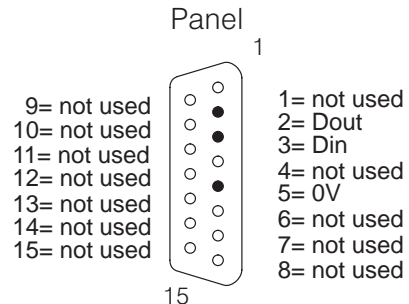

Step 4: Connecting Configuration Cable OP-ACBL-1

Once the example programs are loaded in your personal computer, the first step will be to load the configuration program from the computer into the OP-panel, so make this cable connection first. Connect the configuration cable between the serial port of the OP-panel and the serial port of the personal computer when configuring panels using the OP-WINEDIT software. The OP-WINEDIT software requires you to select the serial port number (com1, com2) being used for configuration. The figure below shows programming cable connectors and wiring specifications. Wiring diagrams refer to the cable connectors, *not* the communication ports.

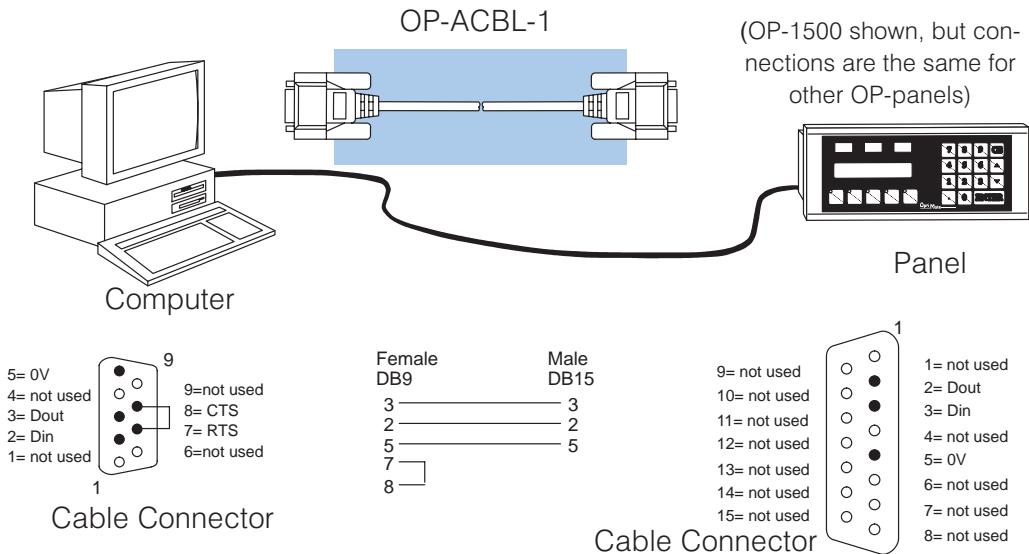

Step 5: Installing the Example Programs on Your Personal Computer Hard Drive

It is possible to load the examples from the diskette; however, we recommend copying them to the hard drive in your computer and keeping the original diskette in a safe place.

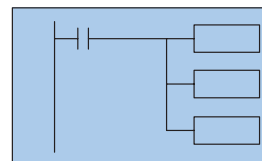

To install the example programs if **using Windows 3.1**, follow these steps:

1. Call up the DOS Prompt. Make a new directory on the hard drive in your computer. For example, if the hard drive is drive C and you are using an OP-620 panel, type:

MD C:\IOP-620

2. Copy all the files from the example program disk to the new directory. For example, if the diskette is in drive A: and the hard drive is drive C:, type:

COPY A:*. * C:\IOP-620*. *

To install the example programs if **using WIN 95**, follow these steps:

1. Select the **Explorer** icon and open. If the hard drive is drive C, select the **(C:)** icon.
2. Make a new directory in the hard drive of your computer. For example, if you are using an OP-620 panel, Select the **File** menu, then select **New** and then **Folder**. Notice the **New Folder** icon that appears. Select the folder and name it "OP-620" by selecting the **File** menu and selecting **Rename**. Type in the new name.
3. Copy all the contents of the example program disk. Insert the diskette in drive A, and select and open the **3 1/2 Floppy (A)** icon. Notice the disk has numerous files of example programs. Select all the programs by opening the **Edit** menu and selecting **Select All**. Open the **Edit** menu again and select **Copy**.
4. Paste the program disk contents into the new C drive "OP-620" directory. Open the "OP-620" directory, open the **Edit** menu and select **Paste**.

The example programs are now loaded onto the hard drive of your computer. Remove the diskette from drive A.

**Step 6: Loading the
OP-WINEDIT
Example Program
into the OP-Panel**

The next step is to load the configuration program into the OP-panel as follows:

1. Open the OP-WINEDIT (also called OPEditor) software.
2. When the initial screen appears, select **Existing System**.
3. A **File Open** window appears. Open the example program file that you just loaded on your hard drive ("OP-620"). A list of files appears, all having ".ocf" after the file name. These are all configuration programs.
4. Select the configuration program for the OP-panel and PLC you are using. For example, if you are using an OP-620 panel with a DL205 PLC, select and open the file titled "620_205.ocf".
5. A screen appears having all the configuration parameters for running the example program using an OP-620 with a DL205 PLC. Make sure your OP-ACBL-1 cable is connected between your personal computer and the OP-panel, that the DIP switch slides are set to ON, and that the OP-panel power supply is on. Select **Configure Panel**.
6. When the next window appears, select **Write to Panel**. This loads the program into the OP-panel.
7. After the program is loaded, close the open windows and select **Exit Software**. This closes out the OP-WINEDIT software.

The OP-panel is now configured, and the OP-ACBL-1 cable can be disconnected.

Step 7: Setting the OP-Panel PRG/RUN DIP Switch to RUN

To run the example programs, set the RUN/PRG DIP switch to RUN.

NOTE: You must cycle power to the panel (turn power off, set DIP switch, and turn power back on) to activate new switch settings.

**Step 8: Loading the DirectSOFT Example Program into the PLC**

The next step is to load the *DirectSOFT* example program into the PLC as follows:

1. Connect the communications cable from your personal computer communications port to your PLC's programming port on the CPU.
2. Start *DirectSOFT* on your personal computer.
3. Select **Open Document**.
4. A dialog box appears. Open the example program file that you just loaded on your hard drive ("OP-620"). A list of files appears, all having ".prj" after the file name. These are the example program files. Notice that the program files are named for the OP-panel and PLC being used and end with ".prj".
5. Select the example program for the OP-panel and PLC you are using. For example, if you are using an OP-620 panel with a DL205 PLC, select and open the file titled "620_205.prj". When the program opens, its ladder rungs will appear on the monitor screen.
6. Select the **PLC** menu, then **Connect**, then select the link to use. All the program examples are saved without PLC link information, so you have to re-connect to your particular CPU. If a message appears which asks you to select the source of program to view, select **Disk**.
7. Make sure the CPU is in Program mode. Then download the program to the CPU. One method is to select the **File** menu, **Write Program...**, then select **To PLC**.
8. When the program download is complete, put the CPU in Run Mode. Select the **PLC** menu, **PLC Modes...**, then select **Run**. The program is now running.

Step 9: Connecting the OP-Panel to the PLC and Running the Program

The next step is to connect the OP-panel to the PLC using the cable you selected earlier. Once the OP-panel is connected to the PLC you can run the program. Read through the following section, Running The OP-620 Example Program, while at the same time doing the setup and actually running the program on your OP-panel. It would be helpful to print a hardcopy of the example program and study the ladder logic to see how the program operates. In addition, see the Kiln Demo Worksheets at the end of this chapter to help understand the program. There are also blank worksheets to use for your own applications.

Running the OP-620 Example Program

In this example program a Cement Kiln System is used to demonstrate the ladder logic required to support the various OP-panel features. The program provides ladder logic which demonstrates controlling pushbuttons, lamps, messages and menu operations.

Items listed in the figure below, such as Hopper Selection, Kiln Speed, Start/Stop/Run controls, and Kiln Zone Temperatures are monitored and controlled by the OP-panel example program.

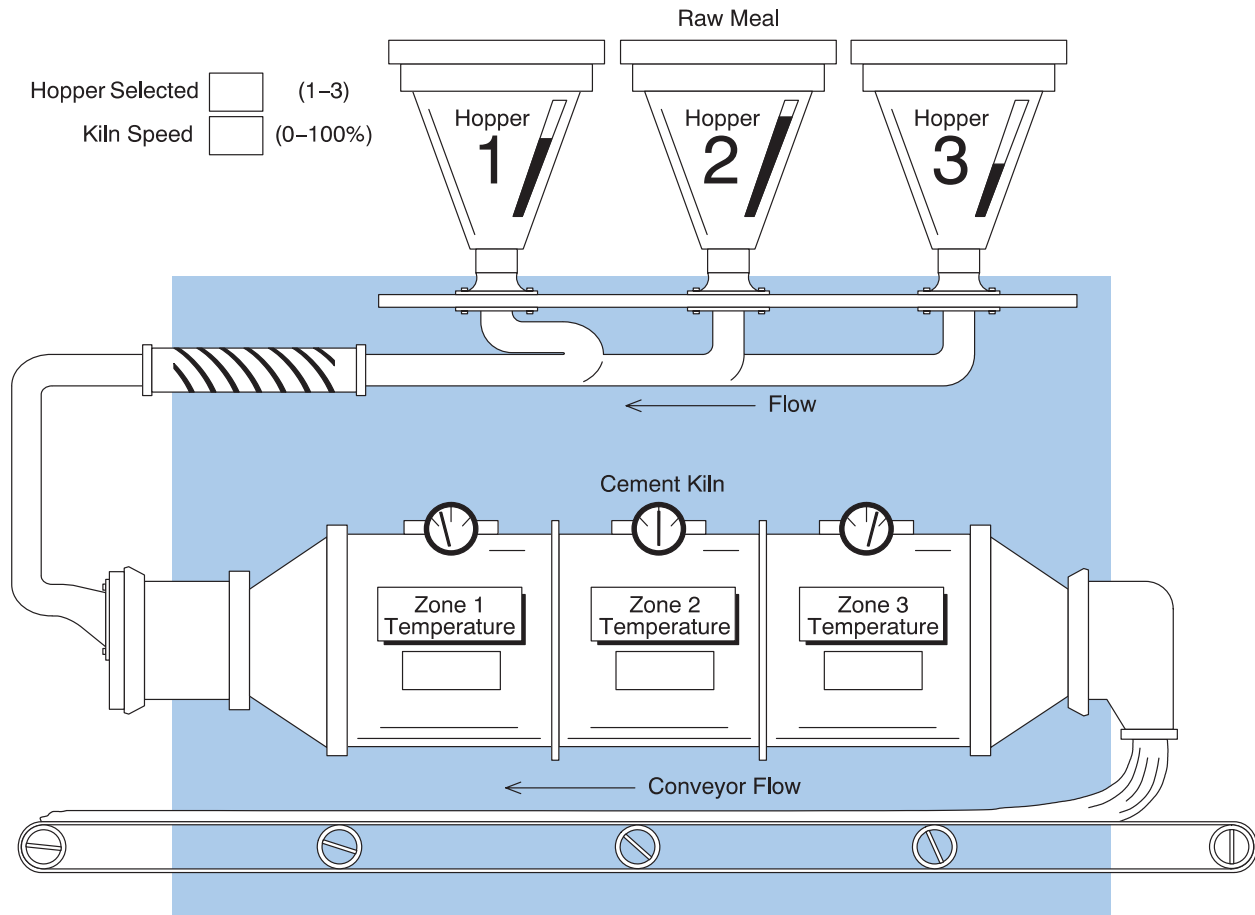

There are two parts to the program: 1. Using the “MENU” function to enter the setup parameters, and 2. Starting and stopping the program. We will discuss setup first.

Use your imagination to picture the operation of the kiln system shown. The first thing we must do is the program setup. There are two main categories of setup parameters, “Raw Meal Control” and “Temperature Control”. We will discuss “Raw Meal Control” first.

There are two parameters which must be setup for “Raw Meal Control”:

- “Hopper Selection”: This parameter selects which hopper is going to provide the material for the kiln system. The choices are Hopper 1, Hopper 2 or Hopper 3.
- “Kiln Speed”: This parameter selects the speed that the material will travel through the kiln system. The speed is specified as a percentage of the maximum possible speed and can be set for any speed between 1% (lowest speed) and 100% (highest speed).

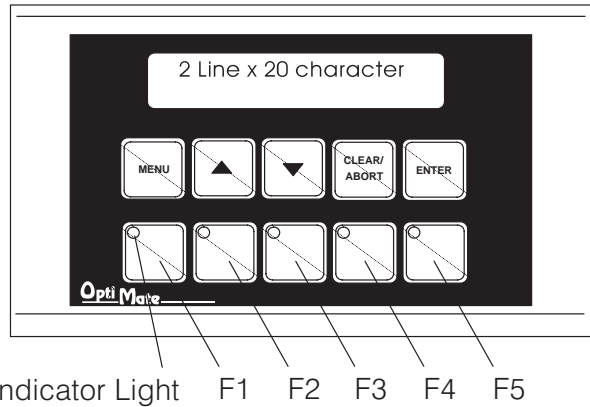

There are three parameters which must be setup for “Temperature Control”:

- “Setpoint Zone1 Temp.”: This parameter selects the temperature that the material will be exposed to while traveling through Temperature Zone 1. The temperature can be set to any setting from 1 to 2,000, with 1 being the lowest temperature setting and 2,000 being the highest.
- “Setpoint Zone2 Temp.”: This parameter selects the temperature that the material will be exposed to while traveling through Temperature Zone 2 and can be set from 1 to 2,000.
- “Setpoint Zone3 Temp.”: This parameter selects the temperature that the material will be exposed to while traveling through Temperature Zone 3 and can be set from 1 to 2,000.

Once all five parameters are setup, we are ready to run the program. This is done by pressing the F1 pushbutton. To stop the program, press F2.

This is a simple program, but it shows how a program can be developed for a practical application for the OP-panel. Follow these step-by-step directions to setup the parameters and run the example program:

1. After starting the *DirectSoft* example program, the initial OP-panel display is:

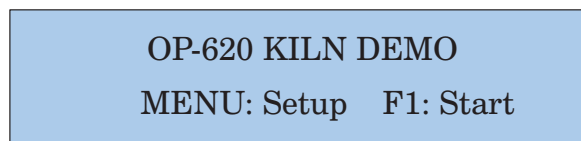

The first thing we want to do is setup the parameters, so press the **Menu** pushbutton to get the following screen:



Press either of the up/down arrow pushbuttons (▲or▼) to get the following screen:

Temperature Control
Enter/Arrow/Clear

Notice that pressing either ▲▼ pushbutton toggles the display between these two screens. These are the two main categories of setup parameters. In the second line of each screen are three choices of pushbutton selections we can make at this point:

- **Enter:** Press this to setup the parameter currently shown.
- **Arrow:** Press either ▲▼ pushbutton to toggle between the two screens.
- **Clear/Abort:** Press this pushbutton to return to the initial screen.

2. Let's setup the Raw Meal Control first, so press either ▲▼ pushbutton to get to that screen, and press **Enter**. The following screen appears:

Hopper Selection
Enter/Arrow/Clear

Press **Enter**. The following screen appears:

Meal Hopper (1-3): 2
Arrow UP/DOWN = 1

Select Hopper 1, 2 or 3 by using the ▲▼ pushbuttons, and pressing **Enter**. For example, the "2" on the top line indicates that Hopper 2 is currently selected. If we wish to change our selection to Hopper 1, press ▲▼ pushbuttons until a "1" is displayed on the bottom line, and press **Enter**. A "1" replaces the "2" on the top line and the display returns to the previous "Hopper Selection" screen.

Pressing **Clear/Abort** cancels any changes made and returns the display to the initial screen.

3. Next we need to set the kiln speed. With the "Hopper Selection" screen displayed, press ▲▼ pushbuttons to get the following screen:

Kiln Speed Control
Enter/Arrow/Clear

4. Press **Enter**. The following screen appears:

```
Kiln Speed (%) : 25
New Kiln Speed = 50
```

Select kiln speed by using the ▲▼ pushbuttons, and pressing **Enter**. For example, the “25” on the top line indicates that a speed of 25% of maximum speed is currently selected. If we wish to change our selection to 50% of maximum speed, press the ▲ pushbutton until a “50” is displayed on the bottom line, and press **Enter**. A “50” replaces the “25” on the top line and the display returns to the previous “Kiln Speed Control” screen.

Both Raw Meal Control parameters are now set. Next we need to set the three Temperature Control parameters.

5. Press **Menu** and use the ▲▼ pushbuttons to select the following Temperature Control screen:

```
Temperature Control
Enter/Arrow/Clear
```

Press **Enter** to get the following screen:

```
Setpoint Zone1 Temp.
Enter/Arrow/Clear
```

First we will set the Zone 1 temperature. Press **Enter** to get the following screen:

```
Zone1 Temp. SP: 100
Enter New Temp= 200
```

Select Zone1 temperature by using the ▲▼ pushbuttons, and pressing **Enter**. For example, the “100” on the top line indicates the current Zone1 temperature setting. If we wish to change our selection to “200”, press the ▲ pushbutton until a “200” is displayed on the bottom line, and press **Enter**. A “200” replaces the “100” on the top line. The Zone1 temperature is now set and the display returns to the following screen:

```
Setpoint Zone1 Temp.
Enter/Arrow/Clear
```

6. We now need to set the Zone 2 and Zone 3 temperatures in the same manner. To set the Zone 2 temperature, press the ▲▼ pushbuttons until the “Zone1” portion of the display changes to “Zone2” as follows:

Setpoint Zone2 Temp.
Enter/Arrow/Clear

Press **Enter**, and set the Zone 2 temperature the same way that you set the Zone 1 temperature. Repeat the same procedure for the Zone 3 temperature.

All setup parameters are now set, and you are ready to run the program.

7. After the last setup parameter is entered, press **Clear/Abort** to return to the following initial screen:

OP-620 KILN DEMO
MENU: Setup F1: Start

To start the program, press the **F1** pushbutton. Notice that the **F1** indicator light momentarily lights and the screen quickly changes to the following:

KILN STARTING
Press F2 to Stop

The above screen only appears momentarily before changing to the following:

SYSTEM RUNNING
Press F2 to Stop

The program is now running using the parameters we preset. If you wish to stop the program, press **F2**. The program stops, the **F2** indicator light goes on, and following screen appears:

KILN SYSTEM STOPPED
Press F2 to Continue

Press **F2** to resume running the program. You have now run through the entire example program.

Print a hardcopy of the example program and study the ladder logic to see how the program operates. Hopefully this example will help you utilize the OP-panel for your own applications.

KILN DEMO EXAMPLE WORKSHEET

PAGE: _____

DESCRIPTION : OP-620 Kiln Demo

System Type _____

Panel Type OP-620

PLC Base Register Addr _____

PLC CONFIGURATION :

PLC Family _____

CPU Model _____

Protocol _____

PLC Address _____

PLC Timout _____

Baud Rate _____

Parity _____

Data/Stop Bits _____

PUSHBUTTONS / LAMPS :

A M (Alternate/Momentary)

F1 Start

F2 Stop

F3 _____

F4 _____

F5 _____

Green Lamp1 System Running

Yellow Lamp2 System Starting

Red Lamp3 System Stopped

MESSAGE:

Text

No. 1	O P - 6 2 0	K I L N	D E M O																	
	Action: N/A Data Type/Format: N/A Range: N/A																			
	Text Message																			
No. 2	M E N U :	S E T U P	F 1 :	S T A R T																
	Action: N/A Data Type/Format: N/A Range: N/A																			
	Text Message																			
No. 3	K I L N	S T A R T I N G																		
	Action: N/A Data Type/Format: N/A Range: N/A																			
	Text Message																			
No. 4	P R E S S	F 2	T O	S T O P																
	Action: N/A Data Type/Format: N/A Range: N/A																			
	Text Message																			
No. 5	S Y S T E M	R U N N I N G																		
	Action: N/A Data Type/Format: N/A Range: N/A																			
	Text Message																			
No. 6	P R E S S	F 2	T O	S T O P																
	Action: N/A Data Type/Format: N/A Range: N/A																			
	Text Message																			
No. 7	K I L N	S Y S T E M	S T O P P E D																	
	Action: N/A Data Type/Format: N/A Range: N/A																			
	Text Message																			
No. 8	P R E S S	F 2	T O	C O N T I N U E																
	Action: N/A Data Type/Format: N/A Range: N/A																			
	Text Message																			
No. 9	M E A L	H O P P E R	(1 - 3) :																	
	Action: N/A Data Type/Format: INTEGER/BCD Range:																			
	Text Message																			
No. 10	A R R O W	U P / D O W N	=																	
	Action: Arrow Data Type/Format: BCD Range: 1-3																			

EXAMPLE MESSAGE WORKSHEET

PAGE: _____

MESSAGE:

		Text Message																				
No. 11		K	I	L	N		S	P	E	E	D		(%)	:	^	^	^	^		
		Action: N/A Data Type/Format: BCD Range: N/A																				
No. 12		N	E	W		K	I	L	N		S	P	E	E	D	=						
		Action: Keypad Data Type/Format: BCD Range: N/A																				
No. 13		Z	O	N	E	1		T	E	M	P		S	P	:	^	^	^	^			
		Action: N/A Data Type/Format: BCD Range: N/A																				
No. 14		E	N	T	E	R		N	E	W		T	E	M	P	.	=	^	^	^	^	
		Action: Keypad Data Type/Format: BCD Range: N/A																				
No. 15		Z	O	N	E	2		T	E	M	P		S	P	:	^	^	^	^			
		Action: N/A Data Type/Format: BCD Range: N/A																				
No. 16		E	N	T	E	R		N	E	W		T	E	M	P	.	=	^	^	^	^	
		Action: Keypad Data Type/Format: BCD Range: N/A																				
No. 17		Z	O	N	E	3		T	E	M	P		S	P	:	^	^	^	^			
		Action: N/A Data Type/Format: BCD Range: N/A																				
No. 18		E	N	T	E	R		N	E	W		T	E	M	P	.	=	^	^	^	^	
		Action: Keypad Data Type/Format: BCD Range: N/A																				
No.																						
		Action: Data Type/Format: Range:																				
No.																						
		Action: Data Type/Format: Range:																				
No.																						
		Action: Data Type/Format: Range:																				
No.																						
		Action: Data Type/Format: Range:																				
No.																						
		Action: Data Type/Format: Range:																				
No.																						
		Action: Data Type/Format: Range:																				
No.																						
		Action: Data Type/Format: Range:																				

EXAMPLE MENU WORKSHEET

PAGE: _____

MENU:

Text

No. 1	R	A	W		M	E	A	L		C	O	N	T	R	O	L				
Menu Level	1	2	3	4	Function No.	-														
No. 2	H	O	P	P	E	R		S	E	L	E	C	T	I	O	N				
Menu Level	1	2	3	4	Function No.	1														
No. 3	K	I	L	N		S	P	E	E	D		C	O	N	T	R	O	L		
Menu Level	1	2	3	4	Function No.	2														
No. 4	T	E	M	P	E	R	A	T	U	R	E		C	O	N	T	R	O	L	
Menu Level	1	2	3	4	Function No.															
No. 5	S	E	T	P	O	I	N	T		Z	O	N	E	1		T	E	M	P	.
Menu Level	1	2	3	4	Function No.	3														
No. 6	S	E	T	P	O	I	N	T		Z	O	N	E	2		T	E	M	P	.
Menu Level	1	2	3	4	Function No.	4														
No. 7	S	E	T	P	O	I	N	T		Z	O	N	E	3		T	E	M	P	.
Menu Level	1	2	3	4	Function No.	5														
No.																				
Menu Level	1	2	3	4	Function No.															
No.																				
Menu Level	1	2	3	4	Function No.															
No.																				
Menu Level	1	2	3	4	Function No.															
No.																				
Menu Level	1	2	3	4	Function No.															
No.																				
Menu Level	1	2	3	4	Function No.															
No.																				
Menu Level	1	2	3	4	Function No.															
No.																				
Menu Level	1	2	3	4	Function No.															
No.																				
Menu Level	1	2	3	4	Function No.															

OP-9001 Multi-Panel Configurations

If you are connecting more than one OptiMate panel to a single CPU this is referred to as multi-panel configuration. Multi-panel configurations require the OP-9001 Communications Master, which the CPU communicates to for obtaining data from the connected OP-panels. The OP-9001 Communications Master looks for an address within the range of 0 to 30 for each panel connected. Each panel connected in a RS-422 link must have a unique address. A more detailed description of multiple panel configuration and installation is given in the OP-9001-M User Manual.

The Termination Resistor

The last panel must be terminated when using a RS-422 communications link by setting DIP switch 2 to the TERM (ON) position. Operator panels communicating more than 50 feet distance *must* use RS-422 and also be properly terminated.

NOTE: Only the *last* panel of each RS-422 link should have the termination DIP switch 2 set to the TERM position. All other panels should have the DIP switch set to the off (left) position. After changing the DIP switch settings, remember to cycle power on panel to activate the new switch settings.
