

DATA SHEET

Premium Efficiency Motor: **MTSN-1P5-3BD18**

60 Hz

Document Generated: 23-Sep-2021

Document ID:

Customer:

MOTOR INFORMATION

HP	1.5
RPM	1800
Phase	3
Frequency	60
Voltage	230/460
Frame Size	56C
Enclosure	TENV
Degree of Protection	IP69K
Service Factor	1.15
Poles	4
Full Load Speed	1755
Insulation Class	F
Temp Rise	80°C
NEMA Code Letter	M
Duty Cycle	S1
Slip	2.50%
NEMA Design	B
Moment of Inertia	0.184 lb.ft.^2
Locked Rotor Time (Hot)	12 seconds
Sound Pressure Level	60 dB(A)
Number of Starts	12
Max Ambient Temperature	40° C
Max Elevation	1000 m.a.s.l (3300 f.a.s.l)
Mounting	F1
Rotation	Bidirectional
Area of Classification	Div.2 Class I, Gr. A,B,C&D T2B
Inverter Rating	10:1 CT/20:1 VT
Standard	NEMA MG1, UL1004
Approvals	CSA,UL,CE

EFFICIENCY/POWER FACTOR

LOAD	EFF	P. F.
100%	86.5 %	0.74
75%	86.0 %	0.67
50%	83.0 %	0.53

TORQUE

FULL LOAD	LRT	BDT
4.4 lb.ft.	300 %	400 %

AMPERAGE INFORMATION

	230V	460V
Full Load Amps	4.4	2.2
Locked Rotor Amps	40	20
No Load Current	2.8	1.4
Usable at 208V	5	

BEARING INFORMATION

DE Bearing	6205 2RS
ODE Bearing	6205 2RS
Grease Type	Mobil Polyrex EM
DE Regreasing Interval	-- Hours
ODE Regreasing Interval	-- Hours
Grease Quantity	--

ADDITIONAL DATA

F2 Suitable	No
Shaft Material	304 Stainless Steel
Connection Diagram	9 Lead 2Y/Y
Approximate Weight	51 lbs.

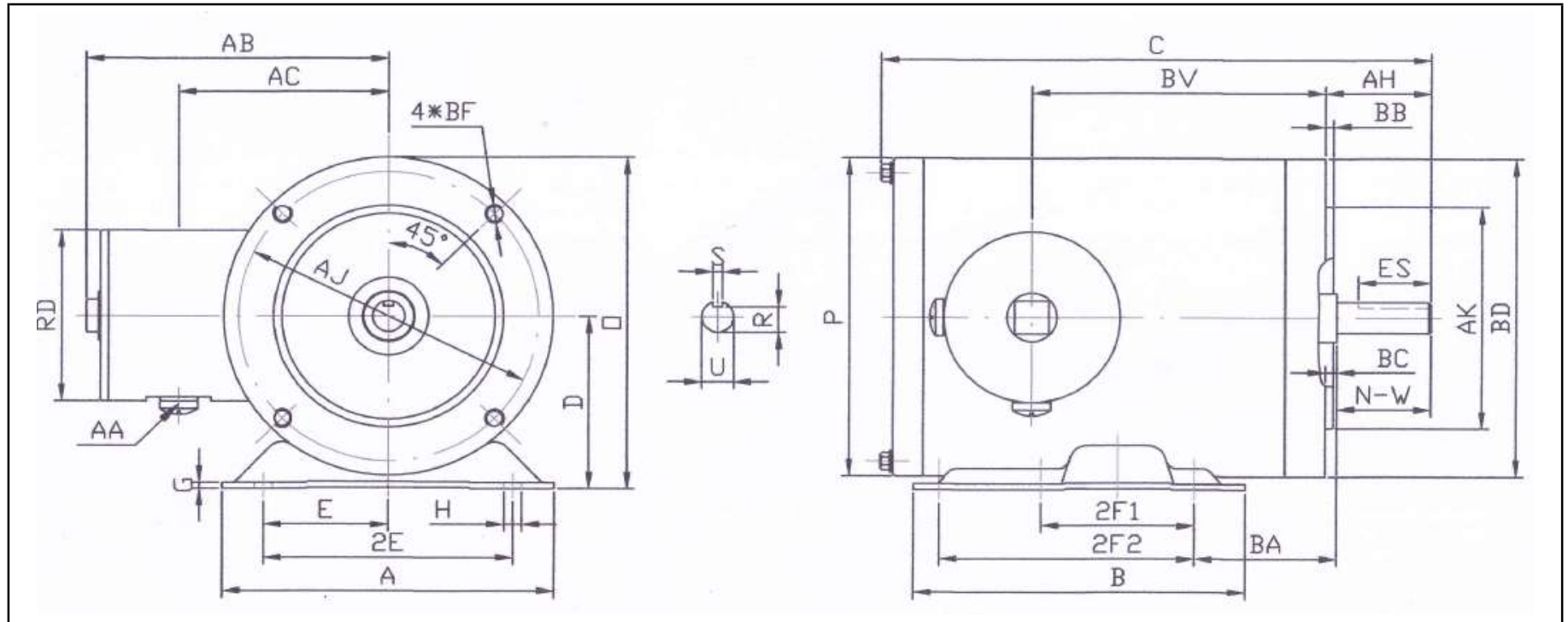

DIMENSIONS - INCHES

MOUNTING					A	B	C	D	G	T	P	O	BC	AB
E	2F1	2F2	H	BA										
2.44	3	5	1.22*0.34	2.75	6.5	5	11.96	3.5	0.118	--	6.45	6.73	-0.19	5.95

SHAFT & KEY					
S	ES	R	N-W	U	AH
0.188	1.41	0.517	1.88	0.625	2.06

TERMINAL BOX				
AA	AB	AC	RD	BV
1/2	5.95	4.5	3.45	6.95

FLANGE				
AK	BD	AJ	BF	BB
4.5	6.45	5.875	(4)3/8-16	0.16

PERFORMANCE CURVES

Premium Efficiency Motor: **MTSN-1P5-3BD18**

Document Generated: 23-Sep-2021	Customer:
Document ID:	

Motor Type	MTS		FL Speed	1755	
Output Rating (HP)	1.5		LRT (%FLT)	300	460 volt FLA 2.2
Full Load Torque	4.4	lb.ft	BDT (%FLT)	400	230 volt FLA 4.4
Rotor Wk^2	0.184	lb-ft^2			

SPEED VS TORQUE & CURRENT CURVE

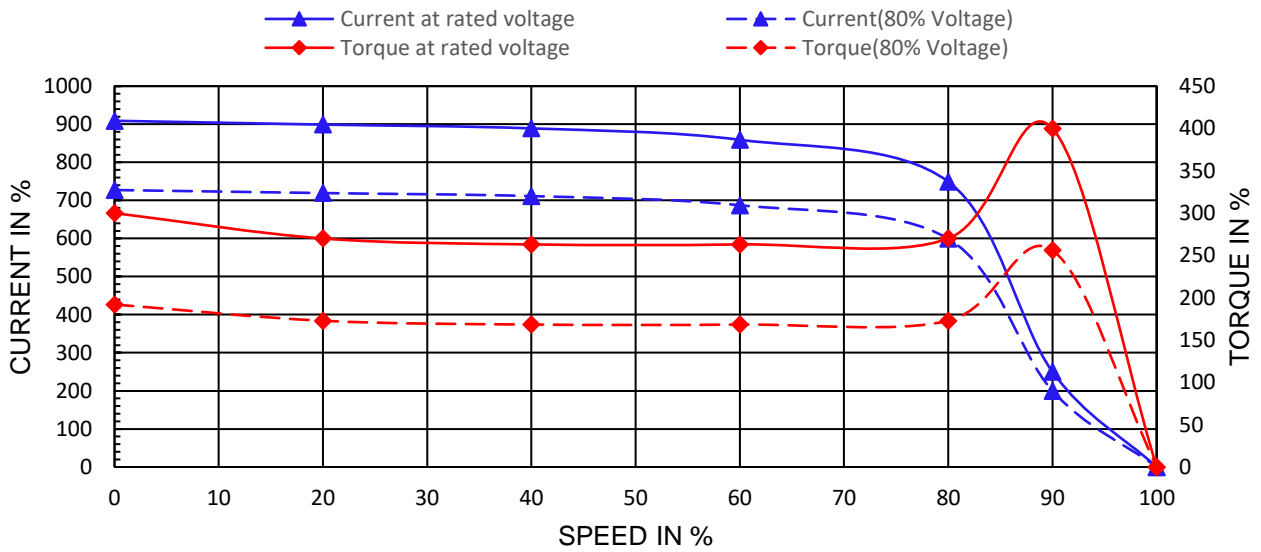

OUTPUT VS EFF., P.F. & CURRENT CURVE

