

# INSTALLATION AND NETWORK LAYOUTS

---



## In This Chapter:

<b>Inserting the ERM Module in the I/O Base</b> .....	<b>3-2</b>
DL205/Do-more Slot Choices .....	3-2
H2-ERM (100, -F) Module Installation .....	3-2
DL405 Slot Choices .....	3-3
H4-ERM (100, -F) Module Installation .....	3-4
Which Modules are Supported in the Ethernet Slaves .....	3-4
<b>ERM Network Layouts</b> .....	<b>3-5</b>
Configuring the Ethernet Remote I/O Network .....	3-5
Running the Ethernet Remote I/O Network .....	3-5
ERM / ECOM Systems .....	3-6
<b>Network Cabling</b> .....	<b>3-7</b>
ERM Supports Three Standards .....	3-7
10/100BaseT Networks .....	3-7
10/100BaseT .....	3-8
UTP Cable .....	3-8
10BaseFL .....	3-8
Fiber Optic Cable .....	3-8
Fiber Optic Module ST Connector .....	3-8
Maximum Cable Length .....	3-9

## Inserting the ERM Module in the I/O Base

### DL205/Do-more Slot Choices

The DL205 and Do-more systems support placement of the ERM module in the CPU-base only. It does not support installation of the ERM in local expansion or remote I/O bases. The number of usable slots depends on how many slots your base has. See the chart below for limitations on slot selection. The D2-230 CPU does not support the ERM modules.

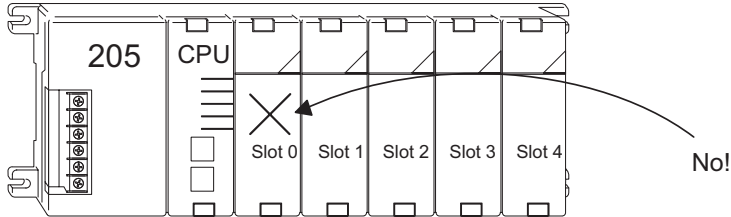

**WARNING:** Your system can be damaged if you install or remove system components before disconnecting the system power. To minimize the risk of equipment damage, electrical shock, or personal injury, always disconnect the system power before installing or removing any system component.

Module Type	CPU	Base	Usable Slots
H2-ERM(100, -F)	DL240 DL250-1 DL260	D2-03B-1, D2-03BDC1-1	1
		D2-04B-1, D2-04BDC1-1	1, 2
		D2-06B-1, D2-06BDC1-1, D2-06BDC2-1	1, 2, 3, 4
		D2-09B-1, D2-09BDC1-1, D2-09BDC2-1	1, 2, 3, 4, 5, 6, 7
	H2-DM1 / H2-DM1E	Any Base	Any Slot

### H2-ERM (100, -F) Module Installation

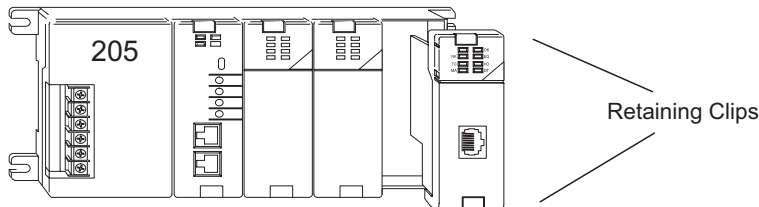

To install the ERM module, line up the module's printed circuit board with the grooves in the base and push the module until it is flush with face of the base power supply. If you feel more than moderate resistance when you push the module into the base, the circuit board may not be aligned with the grooves in the base. When the module is firmly seated in the slot, depress the top and bottom retaining clips to lock the module in place.



**NOTE:** When adding modules to your PLC always confirm that your power budget will accommodate the added module. See the User Manual for your PLC for more information about calculating the power budget. See Appendix A for the power consumption of the ERM modules.

### DL405 Slot Choices

For PLC systems with D4-430 and D4-440 CPUs, the ERM modules can reside in any I/O slot but only in the CPU-base. The D4-450 CPU allows the installation of the ERM module in the CPU-base or in local expansion bases. If the ERM module is used in a local expansion base, all bases in the system must be the “-1” type bases. The valid part numbers for these bases are D4-04B-1, D4-06B-1, and D4-08B-1. The “-1” on the end of the part number indicates that the base supports specialty modules including the ERM. The “-1” bases can be connected as local expansion bases or remote bases. They are not the same thing. Remote bases do not support the ERM modules!

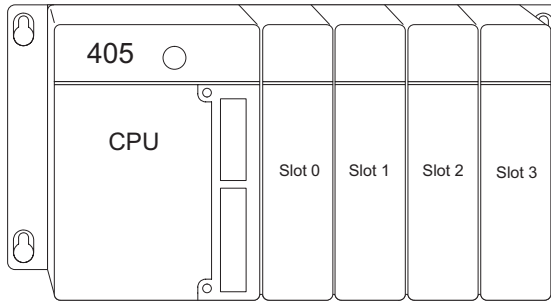

**WARNING:** Your system can be damaged if you install or remove system components before disconnecting the system power. To minimize the risk of equipment damage, electrical shock, or personal injury, always disconnect the system power before installing or removing any system component.

Module Type	CPU	Base	Usable CPU-Base Slots	Usable Expansion Base Slots
H4-ERM(100, -F)	D4-430/440	D4-04B, D4-04B-1	0, 1, 2, 3	N/A
		D4-06B, D4-06B-1	0, 1, 2, 3, 4, 5	N/A
		D4-08B, D4-08B-1	0, 1, 2, 3, 4, 5, 6, 7	N/A
H4-ERM(100, -F)	D4-450	D4-04B	0, 1, 2, 3	N/A
		D4-06B	0, 1, 2, 3, 4, 5	N/A
		D4-08B	0, 1, 2, 3, 4, 5, 6, 7	N/A
H4-ERM(100, -F)	D4-450	D4-04B-1	0, 1, 2, 3	0, 1, 2, 3*
		D4-06B-1	0, 1, 2, 3, 4, 5	0, 1, 2, 3, 4, 5*
		D4-08B-1	0, 1, 2, 3, 4, 5, 6, 7	0, 1, 2, 3, 4, 5, 6, 7*

\* You must use the “-1” base for the CPU-base and all local expansion bases.



**NOTE:** Before installing the ERM module, confirm that your power budget will accommodate the added module. See the PLC user manual for your PLC for more information about calculating the power budget. See Appendix A for the power consumption of the ERM modules.

### H4-ERM(100, -F) Module Installation

To insert the ERM module in a DL405 base, place the bottom tab of the module into the notch at the bottom of the base. Pivot the module toward the base as shown below. Ensure that each module is tightly seated and secured with the captive screw at the top of the module.

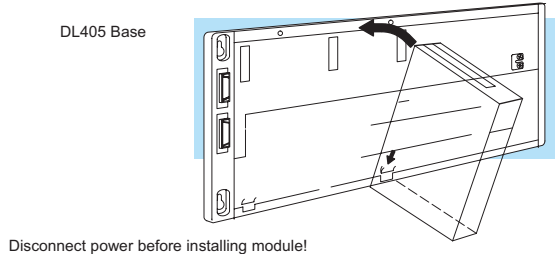

### Which Modules are Supported in the Ethernet Slaves

The Ethernet remote I/O slaves accept the most commonly used I/O modules for the DL205/Do-more, DL405 systems and Terminator I/O systems (AC, DC, AC/DC, Relay an Analog). The table below lists by category those modules that you may use in a remote I/O slave. A few specialty modules that are supported in the slaves are listed below.

Module/Unit	Remote Slave	Module/Unit	Remote Slave
PLC CPUs	No	H2-CTRIO(2)	Yes
DC Input Modules	Yes	D2-CTRINT	No
AC Input Modules	Yes	H4-CTRIO, D4-HSC	Yes
AC/DC Input Modules	Yes	D2-EM	No
DC Output Modules	Yes	Communications and Networking Modules	No
AC Output Modules	Yes		
Relay Output Modules	Yes		
Analog I/O Modules	Yes		
Thermocouple Module	Yes		
RTD Module	Yes		



**NOTE:** The User Manual for Analog I/O Modules discusses scan times for updating analog I/O data for modules installed in local bases. Please be aware that the **scan times for updating are different for remote I/O modules installed in remote bases.** The CPU scan is **asynchronous** with the remote scan by the master module. Thus, an analog input module installed in a remote base, for example, may not have its data updated by the CPU “once every scan per channel” as stated in the user manual. The CPU scan may, in fact, cycle several times while the remote scan is taking place. Take this into account in applications where the timing is critical.

## ERM Network Layouts

Each ERM module can support up to 16 remote slaves (if a WinPLC system is used, only one slave can be supported by the ERM module). The slaves supported are the H4–EBC(–F), H2–EBC(–F), T1H–EBC, GS–EDRV100 and HA–EDRV2. A hub or repeater connects multiple slaves into a star topology. Multiple hubs or repeaters can be used to create a star–bus–star topology. Once the ERM I/O network is configured and running, the PC can be removed from the network.

3

### Configuring the Ethernet Remote I/O Network

Use a PC equipped with a 10/100BaseT or 10BaseFL network adapter card and the Ethernet Remote Master (ERM) Workbench software configuration utility that comes with this manual to configure the ERM module and its slaves over the ethernet remote I/O network.

**PC running ERM Workbench to  
configure the ERM network**

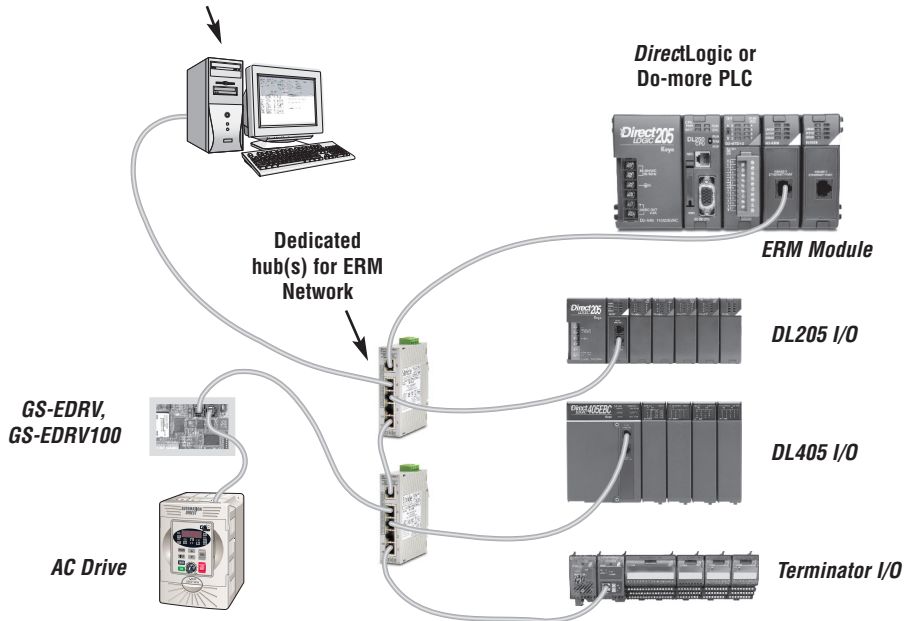

### Running the Ethernet Remote I/O Network

Once the ERM I/O network is configured and running, the PC can be removed from the network.

### ERM / ECOM Systems

Keep ERM networks, multiple ERM networks and ECOM / office networks isolated from one another as shown below. Do not attempt to connect an ECOM module or non ERM Workbench PC to a hub that the dedicated ERM network is using. Having an ECOM module(s) on an ERM Ethernet network can adversely affect the reliability and the speed of the ERM slave I/O.

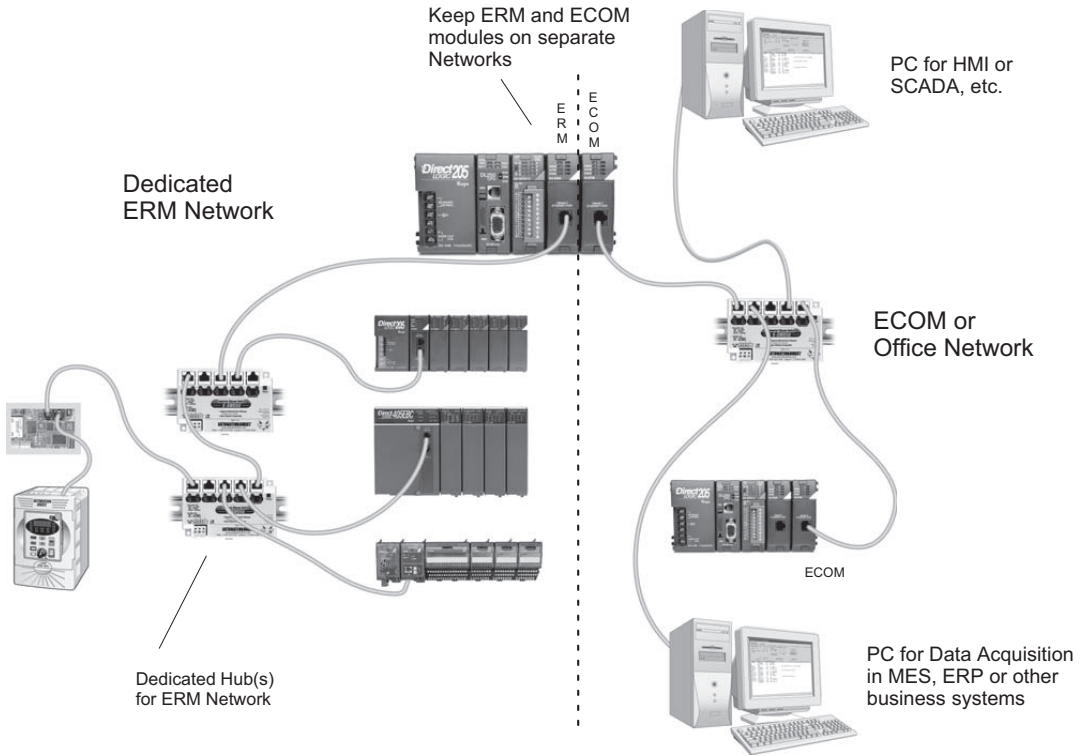

**Warning:** We recommend using a dedicated Ethernet remote I/O network for the ERM and its slaves. While Ethernet networks can handle a very large number of data transmissions, and normally handle them very quickly, heavy Ethernet traffic can adversely affect the reliability of the slave I/O and the speed of the network.

# Network Cabling

## ERM Supports Three Standards

Three types of ERMs are available. The H2-ERM and H4-ERM support the 10BaseT standard. The H2-ERM100 and H4-ERM100 support the 10/100BaseT standard. The H2-ERM-F supports the 10BaseFL standard. The 10/100BaseT standard uses twisted pairs of copper wire conductors, and the 10BaseFL standard is for fiber optic cabling.



## 10/100BaseT Networks

The cable used to connect a PLC (or PC) to a hub or repeater is called a patch (straight-through) cable. The cable used to connect two Ethernet devices (Point-to-Point) together is a crossover cable. We recommend that you purchase cables pre-assembled with connectors for convenient and reliable networking.

This diagram illustrates the standard wire positions in the RJ45 connector. We recommend all ERM 10/100BaseT cables to be Category 5, UTP cable.

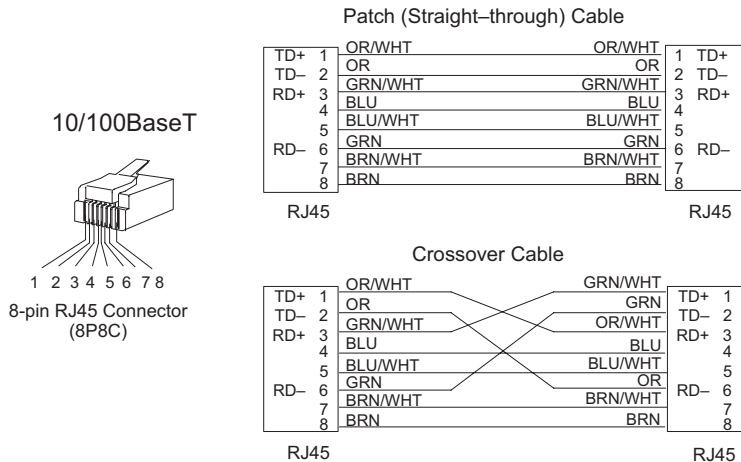

### 10/100BaseT

Most 10/100BaseT hubs or repeaters use a patch (straight-through) cable for connecting the network devices (PLCs or PCs). For hub-to-hub connections a crossover type cable is commonly required. The figures on page 3–6 show pin assignments and insulation color codes for patch (straight-through) and crossover type Ethernet cables.

### UTP Cable

The ERM has an eight-pin modular port that accepts RJ45 type connectors. UTP (Unshielded Twisted-Pair) cable is rated according to its data-carrying ability (bandwidth) and is given a “category” number. We strongly recommend using a category 5 cable for all ERM connections.

### 10BaseFL

Each module has two bayonet ST-style connectors. The ST-style connector uses a quick release coupling which requires a quarter turn to engage or disengage. The connectors provide mechanical and optical alignment of fibers. Each cable segment requires two strands of fiber: one to transmit data and one to receive data. The ST-style connectors are used to connect the H2-ERM-F or H4-ERM-F module to another H2-ERM-F or H4-ERM-F module or a fiber optic hub or repeater.

### Fiber Optic Cable

The H2-ERM-F and H4-ERM-F modules accept 62.5/125 multimode fiber optic (MMF) cable. The glass core diameter is 62.5 micrometers and the glass cladding is 125 micrometers. The fiber optic cable is highly immune to noise and permits communications over much greater distances than 10/100BaseT.

### Fiber Optic Module ST Connector

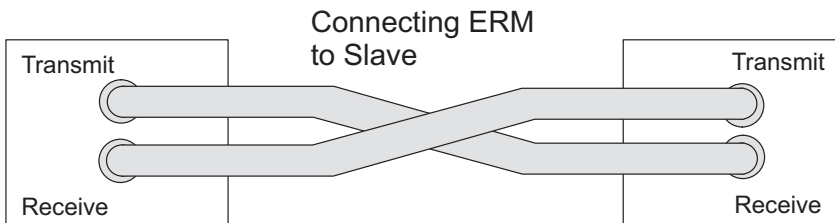
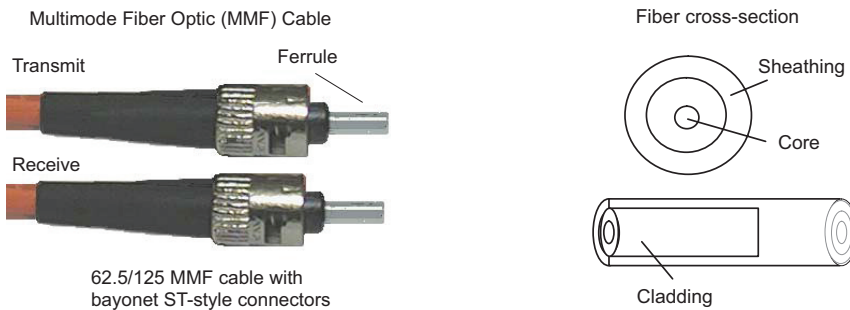



### Maximum Cable Length

The maximum distance per 10/100BaseT cable segment is 100 meters or 328 feet. Repeaters extend the distance. Each cable segment attached to a repeater can be 100 meters. Two repeaters connected together extend the total range to 300 meters. For really long distances, consider using Ethernet/Fiber media converters like the SE-MC2U-ST.

The maximum distance per 10BaseFL cable segment is 2,000 meters or 6,560 feet (1.2 miles). Repeaters extend the distance. Each cable segment attached to a repeater can be 2,000 meters. Two repeaters connected together extend the total range to 6,000 meters.

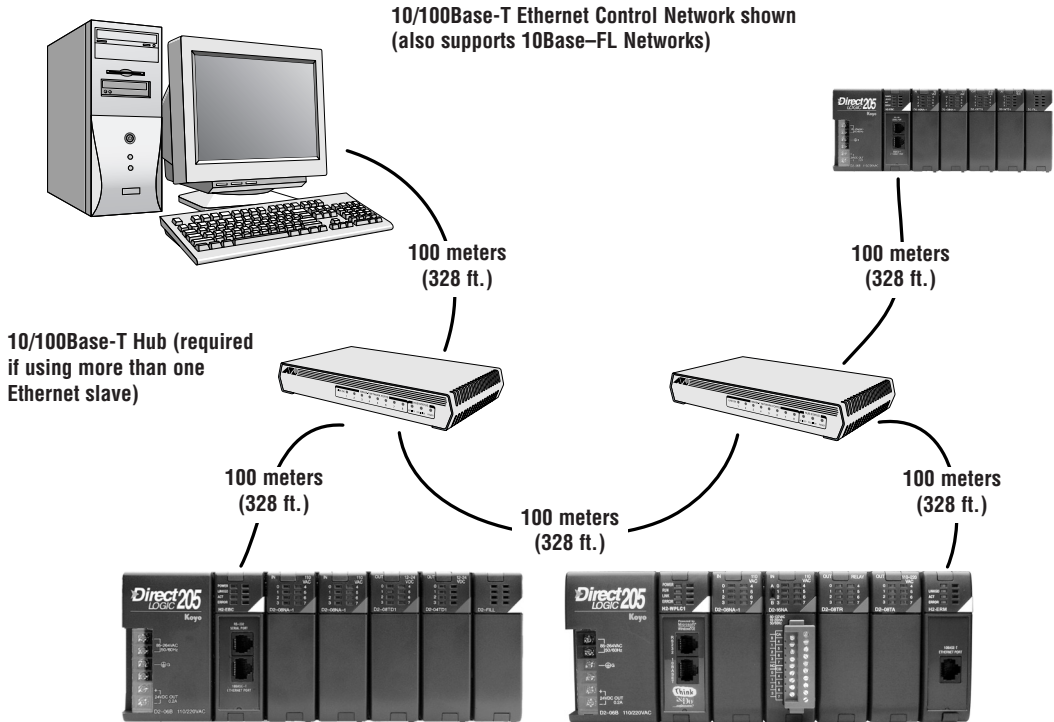

## Notes

3