

# ERM / SLAVE DIAGNOSTICS AND ERROR CODES

---

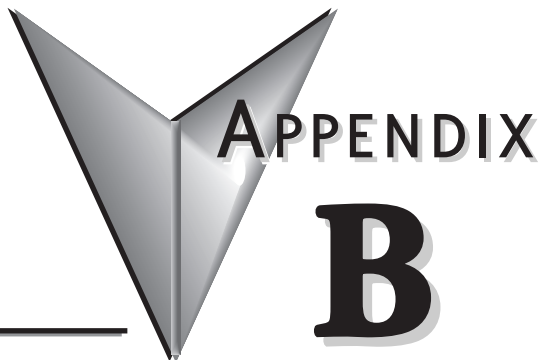

## In This Appendix...

<b>ERM Diagnostics</b> .....	<b>B-2</b>
ERM Status Word / Resetting the Slave .....	B-2
DirectLOGIC Example .....	B-3
Do-more Example .....	B-3
<b>ERM Status Word Error Codes</b> .....	<b>B-4</b>
<b>Reading ERM Statistics</b> .....	<b>B-5</b>
Reading ERM Statistics using Ladder Logic with DirectLOGiC .....	B-5
Reading ERM Statistics using Ladder Logic with Do-more .....	B-6
<b>Reading Error Codes from Slaves</b> .....	<b>B-7</b>
Reading Error Codes from Slaves with DirectLOGIC .....	B-7
Reading Error Codes from Slaves with Do-more .....	B-9
<b>Slave Diagnostic Word Memory</b> .....	<b>B-10</b>
<b>Current / Last State Slave Error Codes</b> .....	<b>B-12</b>
<b>Extended Slave Error Codes</b> .....	<b>B-13</b>

## ERM Diagnostics

The first two words of memory in the Discrete Input table is used for ERM/slave status information, and the first word of memory in the Discrete Output table is for Disable Slave Command bits. The default memory addresses DLX300/X300 and DLY300/Y300 are used in this example.

B

### Do-more

#### Slave Status Bits

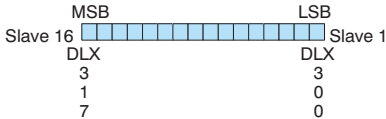

The Slave Status Bits can be monitored to detect if a slave is in error.

#### ERM Status Word

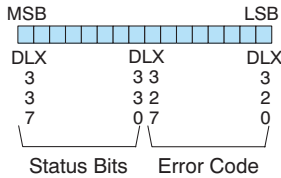

The ERM Status Word contains the ERM error code and Status Bits (see the following description and Error Codes in Appendix B). Bit 8 indicates that the ERM is disabling a slave.

### Disable Slave Bits

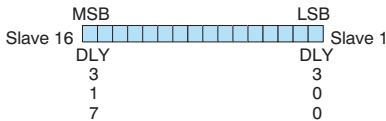

The Disable Slave Bits can be used to disable a slave from communicating with the ERM module. Bit ON = disable that specific slave. RESET = re-enable the specific slave.

### DirectLOGIC

#### Slave Status Bits

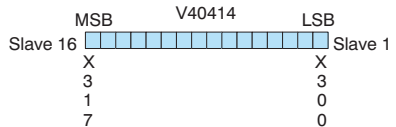

#### ERM Status Word

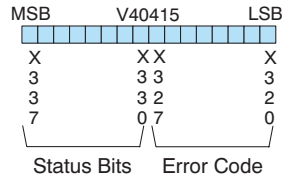

### Disable Slave Bits

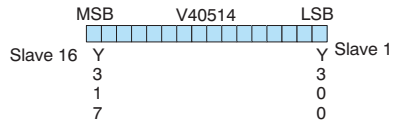

## ERM Status Word / Resetting the Slave

The ERM Status Word contains the current ERM Error Code in the Least Significant Byte and the Status Bits in the Most Significant Byte. Currently, only bit 8 is used in the MSB designating the ERM is disabling Slave.

When using the Slave Disable Bits, the ERM must recognize the request to disable a slave before attempting to re-enable that slave. This closed loop feedback is necessary due to the asynchronous scans of the ERM and PLC. X330 (DirectLOGIC) or DLX330 (Do-more) is the only feedback bit for ALL slave disabling bits (DLY300/Y300 – DLY317/Y317). Either disable multiple slaves all on the same scan or serialize the disable process by using ladder logic interlocks.

Use the following ladder logic code to manually reset a slave. For example, use this resetting method when “Hot Swapping” a Terminator I/O module on a slave that is set up to be *manually* reset using ladder logic. The default for the Terminator EBC is *automatic* rescan after “Hot Swapping” and I/O module.

### DirectLOGIC Example

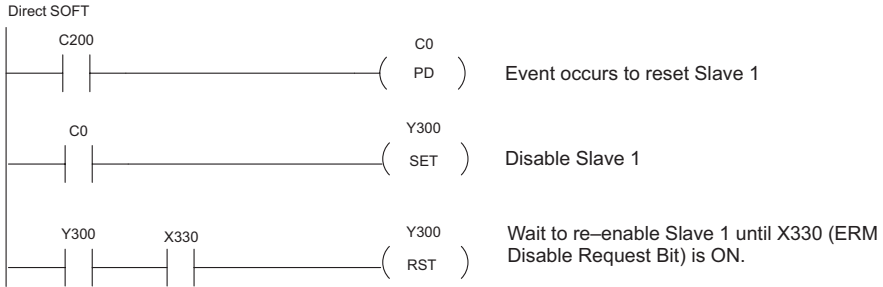

### Do-more Example

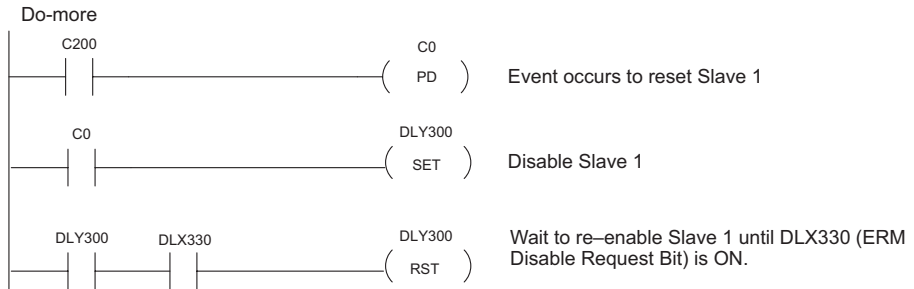

## ERM Status Word Error Codes

The following table describes the errors that will be reported to the ERM Status Word.

Error Code (Decimal)	Description
E0	No error.
E3	Configured bit inputs overlap system input bits.
E4	Configured bit outputs overlap system output bits.
E5	More than one device found with same module ID.
E6	More than one device found with same IP address.
E7	ERM could not read slave's error information – slave not responding.
E8	Device not supported; may be old firmware or configuration error.
E9	Device timed out on a function request after retrys.
E13	Gateway address needed, but not specified
E14	Subnet mask needed, but not specified.
E15	Configured module ID's do not match modules in device.
E16	Number of bit inputs specified in ERM is less than actual in slaves.
E17	Number of bit outputs specified in ERM is less than actual in slaves.
E18	Number of word inputs specified in ERM is less than actual in slaves.
E19	Number of word outputs specified in ERM is less than actual in slaves.
E20	Invalid base definition for this device.
E21	ERM has not been configured
E22	Overflow of internal buffer E22.
E23	Overflow of internal buffer E23.
E24	Overflow of internal buffer E24.
E25	Overflow of internal buffer E25.
E26	Overflow of internal buffer E26.
E27	Configuration error: input words configured not enough.
E28	Configuration error: output words configured not enough.
E221	ERM to CPU backplane error.
E223	PLC family unknown.
E224	ERM to CPU backplane error.
E225	Backplane code error returned from PLC.
E226	General backplane error returned from PLC.
E227	Timeout on PLC backplane error.
E228	ERM to CPU backplane error.
E231	ERM to CPU backplane error.

## Reading ERM Statistics

### Reading ERM Statistics using Ladder Logic with DirectLOGIC

The following ladder logic example reads the ERM statistics from the ERM module. 12 words (24 bytes) of statistical data are stored in the ERM's memory starting at V0 (TA0). Use slave address of 90 when reading ERM statistics. In the example below, the RX instruction stores the statistical data from the ERM module to V1400 – V1413 in the CPU's memory. More information on the RX network instruction can be found in the PLC User Manual. The ERM module is located in slot 2 of the I/O base in this example. Refer to the Special Relays Appendix in the PLC User Manual to identify each slot's Module Busy and Comm Error bits.

The format of the ERM's statistics is as follows:

PLC Address	Description of Statistic	Format
Addr + 0	Minimum I/O Scan in milliseconds	Word / Decimal
Addr + 1	Maximum I/O Scan in milliseconds	Word / Decimal
Addr + 2,3	Total accumulated time in milliseconds	DWord / Decimal
Addr + 4,5	Total number of I/O Scans	DWord / Decimal
Addr + 6,7	Number of PLC Read Retries	DWord / Decimal
Addr + 10,11	Number of PLC Write Retries	DWord / Decimal
Addr + 12,13	Number of Slave Retries	DWord / Decimal

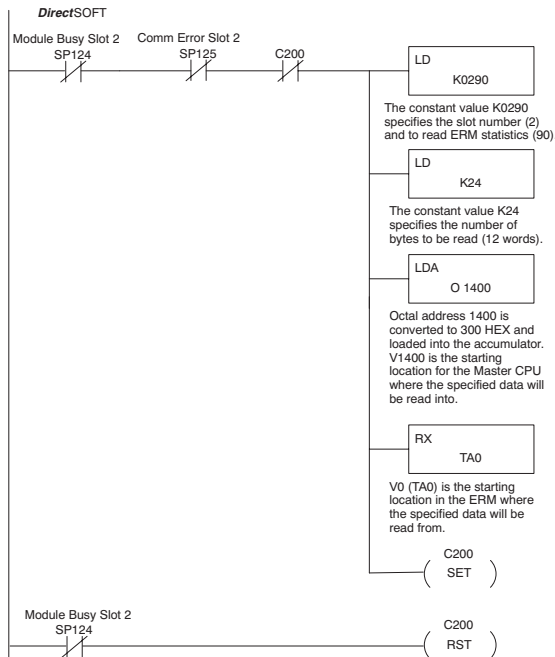

### Reading ERM Statistics using Ladder Logic with Do-more

The following ladder logic example reads the ERM statistics from the ERM module. 12 words (24 bytes) of statistical data are stored in the ERM's memory starting at V0 (TA0). Use slave address of 90 when reading ERM statistics. In the example below, the DLRX instruction stores the statistical data from the ERM module to V100 – V111 in the CPU's memory. More information on the DLRX network instruction can be found in the Do-more help file. The ERM module is located in slot 2 of the I/O base in this example. Interlocking is not required in Do-more. Turning on C10 will result in one read of the ERM.

PLC Address	Description of Statistic	Format
Addr + 0	Minimum I/O Scan in milliseconds	Word / Decimal
Addr + 1	Maximum I/O Scan in milliseconds	Word / Decimal
Addr + 2,3	Total accumulated time in milliseconds	DWord / Decimal
Addr + 4,5	Total number of I/O Scans	DWord / Decimal
Addr + 6,7	Number of PLC Read Retries	DWord / Decimal
Addr + 8,9	Number of PLC Write Retries	DWord / Decimal
Addr + 10,11	Number of Slave Retries	DWord / Decimal

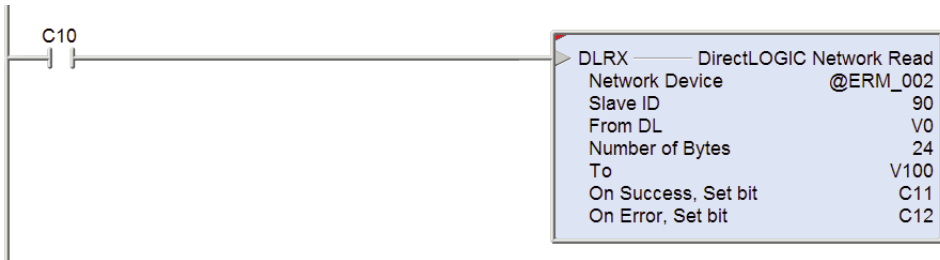

# Reading Error Codes from Slaves

## Reading Error Codes from Slaves with DirectLOGIC

The following ladder logic example reads the Error Codes from three slaves (1–3). The slaves' error data is stored in their memory starting at V0 (TA0). Up to 36 words (72 bytes) of error codes can be read from a slave depending on the number of bases and I/O modules (slots) used per slave. In the example below, the RX instruction stores the Error data read from Slave 1 to V2000 – V2013 and from Slave 2 to V2020 – V2033, etc. in the CPU's memory. More information on the RX network instruction can be found in the PLC User Manual The ERM module is located in slot 2 of the 205 I/O base in this example. Refer to the Special Relays Appendix in the PLC User Manual to identify each slot's Module Busy and Comm Error bits. Refer to the Slave Diagnostic Word Memory Table in this chapter for a description of the word information read from the slaves. This example reads words V0 – V11 (24 bytes) from the slaves.

**B**

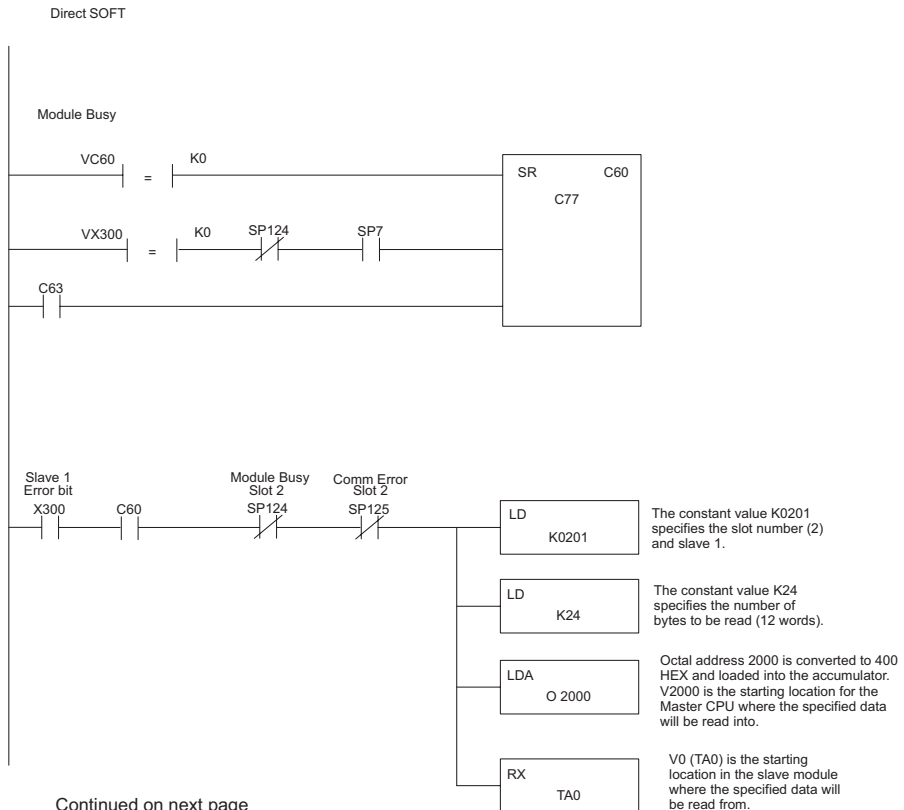

Continued from previous page

**B**

Continued from previous page

Direct SOFT

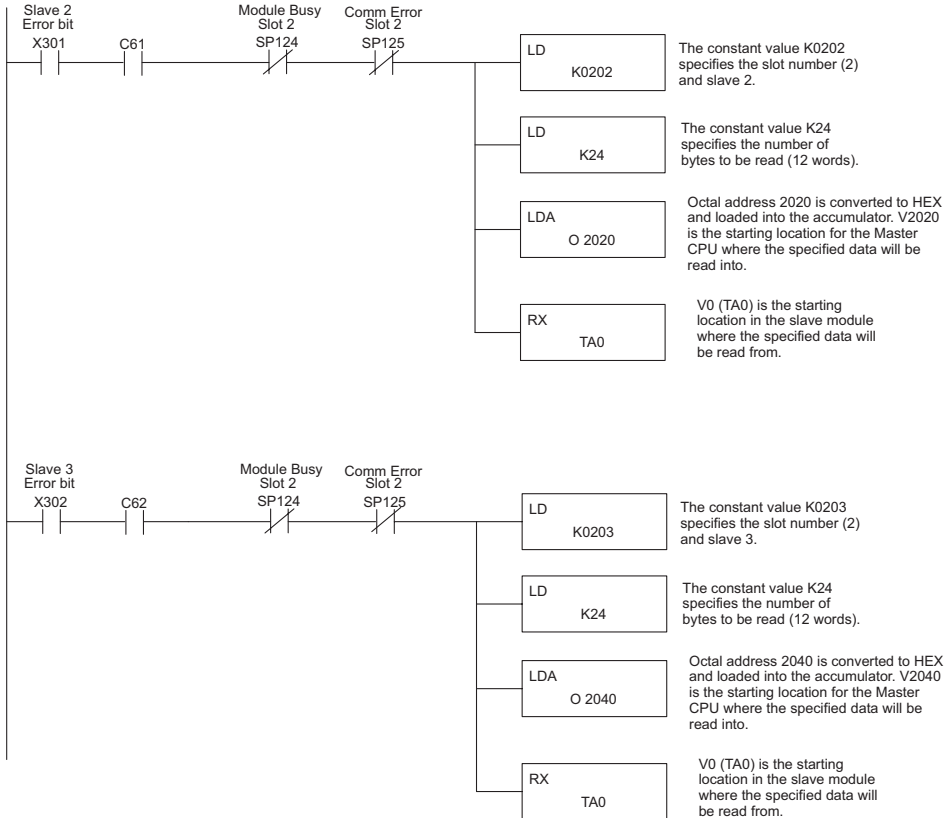



### Reading Error Codes from Slaves with Do-more

The following ladder logic example reads the Error Codes from slaves (1–3). The slaves' error data is stored in their memory starting at V0 (TA0). Up to 36 words (72 bytes) of error codes can be read from a slave depending on the number of bases and I/O modules (slots) used per slave. In the example below, the DLRX instructions read 24 bytes of Error data from Slave 1 to CPU memory V200 – V211, from Slave 2 to CPU memory V212 – V223 and from Slave 3 to CPU memory V224 – V235. More information on the DLRX network instruction can be found in the Do-more help file. The ERM module is located in slot 2 of the 205 I/O base in this example. Refer to the Slave Diagnostic Word Memory Table on the following page for a description of the word information read from the slaves. Interlocking reads to the three slaves is not required. Turning on C13 will result in one read of Slave 1, then a read of Slave 2, then a read of Slave 3.

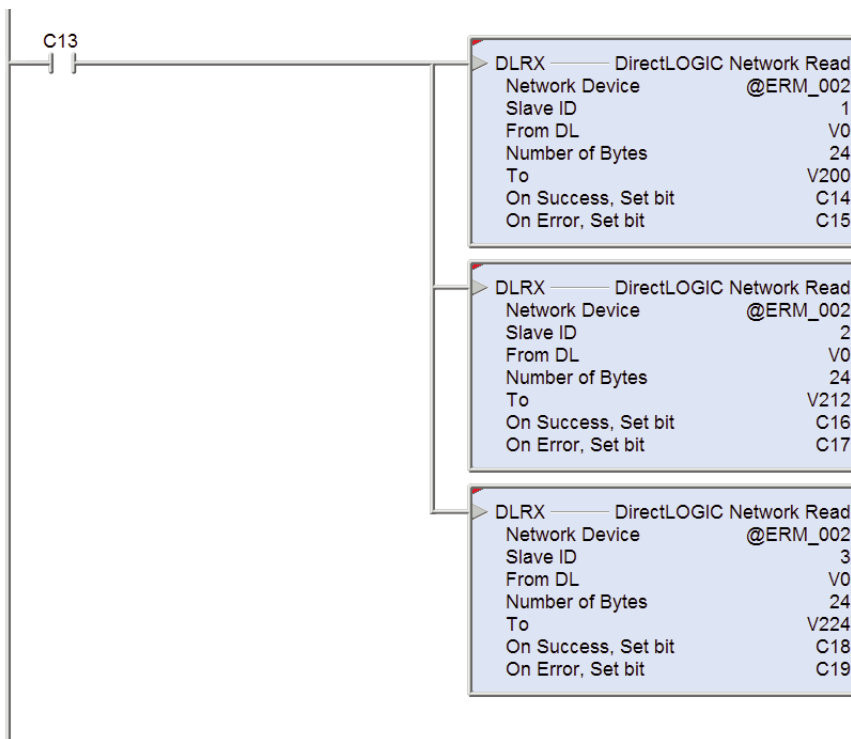

## Slave Diagnostic Word Memory

The following table describes the Word information that is obtained when a slave's diagnostic information is read (RX) by the PLC CPU into its memory. Applies to 205/405 and Terminator EBC modules.

Word	Description
V +0	Current slave error code: Bits 0 – 11 Type of Error: Bits 12–15: ( Bit 12 SET = I/O Error Condition;SET = I/O Warning) Bit 13
V +1	Slave module slot in error (slots 0 – 15).
V +2	Slave module slot in error (slots 16 – 31).
V +3	Slave's Last error code
V +4	Extended error code module in slot 0.
V +5	Extended error code for module in slot 1.
V +6	Extended error code for module in slot 2.
V +7	Extended error code for module in slot 3.
V +8	Extended error code for module in slot 4.
V +9	Extended error code for module in slot 5.
V +10	Extended error code for module in slot 6.
V +11	Extended error code for module in slot 7.
V +12	Extended error code for module in slot 8 or base 1 slot 0.
V +13	Extended error code for module in slot 9 or base 1 slot 1.
V +14	Extended error code for module in slot 10 or base 1 slot 2.
V +15	Extended error code for module in slot 11 or base 1 slot 3.
V +16	Extended error code for module in slot 12 or base 1 slot 4.
V +17	Extended error code for module in slot 13 or base 1 slot 5.
V +18	Extended error code for module in slot 14 or base 1 slot 6.
V +19	Extended error code for module in slot 15 or base 1 slot 7.
V +20	Extended error code for module in slot 16 or base 2 slot 0.
V +21	Extended error code for module in slot 17 or base 2 slot 1.
V +22	Extended error code for module in slot 18 or base 2 slot 2.
V +23	Extended error code for module in slot 19 or base 2 slot 3.
V +24	Extended error code for module in slot 20 or base 2 slot 4.
V +25	Extended error code for module in slot 21 or base 2 slot 5.
V +26	Extended error code for module in slot 22 or base 2 slot 6.
V +27	Extended error code for module in slot 23 or base 2 slot 7.
V +28	Extended error code for module in slot 24 or base 3 slot 0.
V +29	Extended error code for module in slot 25 or base 3 slot 1.
V +30	Extended error code for module in slot 26 or base 3 slot 2.

Continued on following page

Continued from previous page

Word	Description
V +31	Extended error code for module in slot 27 or base 3 slot 3
V +32	Extended error code for module in slot 28 or base 3 slot 4.
V +33	Extended error code for module in slot 29 or base 3 slot 5.
V +34	Extended error code for module in slot 30 or base 3 slot 6.
V +35	Extended error code for module in slot 31 or base 3 slot 7.

**B**

## Current / Last State Slave Error Codes

The following table lists the Current and Last State Slave error codes for Word 0 and Word 3 in the Slave Diagnostic Word Memory Table. Applies to 205/405 and Terminator EBC modules.

Error Code (Decimal)	Description
E0	No error.
E121	Channel failure.
E122	Unused analog input channels exist.
E139	Broken transmitter on one of the analog input channels (if supported by analog module)
E142	Multiple channels failed.
E153	The module which was in this slot is no longer responding. User has removed a module in a Terminator I/O slave system. If Automatic Reset (default) is enabled for this slave, it will reset itself once the replacement module is inserted. If Manual Reset is enabled for this slave, the user must 1) SET the slave disable flag for that slave in the first diagnostic output word, 2) wait for bits 8–15 in second diagnostic input word to equal 1, then 3)RESET the slave disable flag in the first diagnostic output word.
E154	I/O configuration has changed. See E153 for reset methods.
E200–E216	Unused analog input channels exist at channel xx (1–16), where xx = Value –200.(example: E212 indicates unused analog channel exists at channel 12.

## Extended Slave Error Codes

The following table lists the Extended Slave error codes for Words 4–35 in the Slave Diagnostic Word Memory Table. Applies to 205/405 and Terminator EBC modules.

Error Code (Decimal)	Description
E32–E63	Bitwise error where bit 5 is always SET. Look at bit 0 thru bit 4 to get a possible list of errors. Example 34 decimal =22 hexadecimal (Bit 5 SET and Bit 1 SET). BIT ..... Type of Error 0 ..... Terminal block off 1 ..... External P/S voltage low 2 ..... Fuse blown 3 ..... Bus error 4 Module initialization error (intelligent module) 5 Fault exists in module (this bit is SET if any of the above bits are SET)
E117	Write attempt to an invalid analog channel.
E119	Data not valid. Subnet mask or IP address not allowed // EBC SDK data packet not constructed properly.
E121	Analog input channel error.
E122	Unused analog input channels exist.
E139	Broken transmitter on one of the analog input channels.
E142	Channel failure.
E146	Communications failure. Hitachi drive on-board relay set.
E153	The module which was in this slot is no longer responding. User has removed a module in a Terminator I/O slave system. If Automatic Reset is enabled for this slave, it will reset itself once the replacement module is inserted. If Manual Reset is enabled for this slave, the user must 1) SET the slave disable flag for that slave in the first diagnostic output word, 2) wait for bits 12–15 in second diagnostic input word to equal 1, then 3) RESET the slave disable flag in the first diagnostic output word.
E154	One or more new modules has been inserted into the base. See E153 for reset methods.
E155	Terminator module status error. One or more of the modules in the T1H–EBC base has an error. For more detail check extended errors
E200– E216	Unused analog input channels exist at channel xx (1–16), where xx = Value –200.

**Notes:**

**B**