

# GS-EDRV(100) USER MANUAL

# CONTENTS

---

<b>Manual Overview</b> .....	<b>2</b>
Overview of this Publication.....	2
Who Should Read This Manual.....	2
Supplemental Publications.....	2
Technical Support.....	2
Special Symbols.....	2
<b>GS-EDRV Overview</b> .....	<b>3</b>
Package Contents.....	4
<b>GS-EDRV Board Layout</b> .....	<b>5</b>
Power Terminals.....	5
Communication Ports.....	6
DIP Switches.....	6
LED Indicators.....	6
<b>Setting the GS-EDRV Address</b> .....	<b>7</b>
Setting Module ID with DIP Switches.....	7
Setting TCP/IP Address with NetEdit.....	8
<b>GS-EDRV Network Connections</b> .....	<b>9</b>
<b>GS-EDRV100 Overview</b> .....	<b>10</b>
Package Contents.....	12
<b>GS-EDRV100 Layout</b> .....	<b>13</b>
Power Terminals.....	13
Communication Ports.....	13

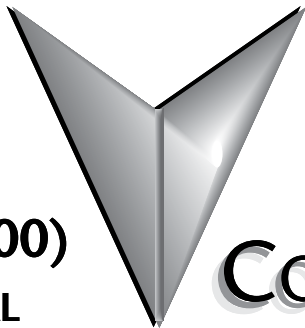

# **GS-EDRV(100) USER MANUAL**

# **CONTENTS**

---

DIP Switches.....	14
LED Indicators.....	14
<b>Setting the GS-EDRV100 Address.....</b>	<b>15</b>
Setting Module ID with DIP Switches.....	15
Setting TCP/IP Address with NetEdit.....	16
<b>GS-EDRV100 Network Connections.....</b>	<b>17</b>
<b>GS-EDRV(100) to GS Series AC Drive Connection... 18</b>	<b>18</b>
Setting the GS Series AC Drive Parameters.....	18
<b>GS-EDRV(100) to ERM Module Connection..... 19</b>	<b>19</b>
Reserved PLC Memory for the GS-EDRV(100).....	19
<b>Reading/Writing From/To the Drive..... 20</b>	<b>20</b>
Input/Output Word Map.....	20
Examples – I/O Word Mapping.....	23
<b>Built-in Web Server..... 25</b>	<b>25</b>
<b>Troubleshooting – H24-ERM-M..... 25</b>	<b>25</b>
Refer to Ethernet Remote Master User Manual H24-ERM-M.....	25
<b>Application Example: Modbus TCP/IP..... 26</b>	<b>26</b>

# Manual Overview

## Overview of this Publication

The GS AC Drive Ethernet Interface User Manual describes the installation, configuration, and operation of GS AC Drive Ethernet Interface cards.

## Who Should Read This Manual

This manual contains important information for those who will install, maintain, and/or operate any GS Series AC Drive Ethernet Interface card.

## Supplemental Publications

The **Ethernet Remote Master Module Manual** (H24-ERM-M) is available from **AutomationDirect** and may be useful for your application.

## Technical Support

**By Telephone: 770-844-4200**  
(Mon.-Fri., 9:00 a.m.-6:00 p.m. E.T.)

**On the Web: [www.automationdirect.com](http://www.automationdirect.com)**

Our technical support group is glad to work with you in answering your questions. If you cannot find the solution to your particular application, or, if for any reason you need additional technical assistance, please call technical support at **770-844-4200**. We are available weekdays from 9:00 a.m. to 6:00 p.m. Eastern Time.

We also encourage you to visit our web site where you can find technical and non-technical information about our products and our company. Visit us at **[www.automationdirect.com](http://www.automationdirect.com)**.

## Special Symbols



*When you see the “notepad” icon in the left-hand margin, the paragraph to its immediate right will be a special note.*

---



**When you see the “exclamation mark” icon in the left-hand margin, the paragraph to its immediate right will be a WARNING. This information could prevent injury, loss of property, or even death (in extreme cases).**

---

## GS-EDRV Overview

The GS-EDRV provides a low-cost, high-performance 10BaseT Ethernet link between a control system and a GS Series AC Drive. The control system can be any of the following:

- DL205 CPU, DL405 CPU, or a WinPLC, with the appropriate Ethernet Remote Master module (H2-ERM or H4-ERM).
- A Productivity3000 CPU using the onboard Ethernet port.
- A PC running Entivity's ThinknDo software, a PC using a custom device driver that was developed using our Ethernet SDK, or a PC running **KEPDirect** EBC or OPC Server.
- Any independent I/O controller with a Modbus TCP/IP driver.

The GS-EDRV mounts on DIN rail and utilizes cable connections and, if needed, Ethernet switches or hubs to communicate to the AC drive.

The functions of the interface are as follows:

- process input signals from the AC drive.
- format these signals to conform to the Ethernet standard.
- transmit converted signals to the control system.
- receive and translate output signals from the control system.
- sends the output signals to the drive.

The control function is NOT performed by the interface. The control function is performed by one of the control systems mentioned above. The I/O mapping function is performed by an H2(4)-ERM module (purchased separately). The H2(4)-ERM module is configured with the ERM Workbench Utility which is part of the **DirectSOFT** PLC programming software.

### Package Contents

After receiving the GS-EDRV, please check for the following:

- Make sure that the part number indicated on the package corresponds with the part number of your order.
- Make sure that the package includes a GS AC Drive Ethernet Interface card (GS-EDRV), one piece of **SNAPTRACK™**, two DIN mounting clips, and one serial connection cable.
- Inspect the contents to insure they were not damaged during shipment.



# GS-EDRV Board Layout

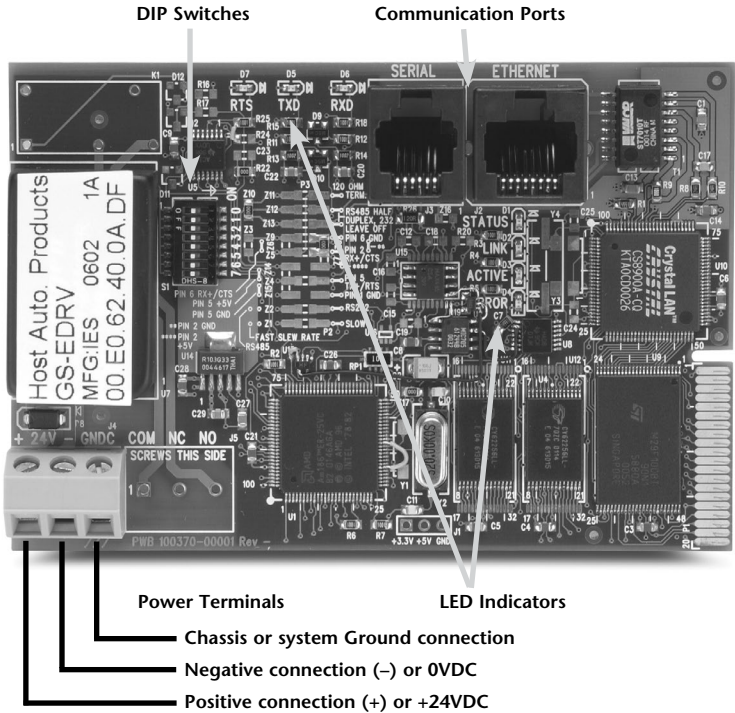

## Power Terminals

Power for the GS-EDRV is connected directly to the card using a nominal 24VDC supply (+24VDC, -0VDC). The GNDNC terminal is for a chassis or system Ground.

## Input Voltage

18–33 VDC with a 24VDC nominal supply

## Input Current

90–135 mA

### Communication Ports

Two comm ports are provided to make the connection from a GS Series AC drive (Serial port) to an Ethernet device or network (Ethernet port).

### DIP Switches

The DIP Switches are used to set the Module ID for the GS-EDRV card.

### LED Indicators

#### STATUS Indicator

The green STATUS LED is steady ON when the GS-EDRV is connected to a GS Series AC drive and communication has been established.

#### LINK

The green LINK LED is steady ON when the GS-EDRV is correctly connected to an active device on the network. The LINK LED verifies that the proper cables are connected, and the card is functioning correctly. If a mismatch with the 10BaseT connections occurs this LED will not be illuminated.

#### ACTIVE

The green ACTIVE LED flashes to indicate that the card sees data travelling on the network. If any network device is sending or receiving data, the ACTIVE LED will be illuminated. In idle mode (no network traffic) this LED is OFF. During heavy communication loads this LED will be steady ON.

#### ERROR Indicator

If the GS-EDRV's red Error (ERROR) indicator is flashing or steady ON, a fatal error has occurred. The error may be in the card itself, or a network problem may be causing this symptom. The ERROR indication can be caused by a faulty ground, an electrical spike or other types of electrical disturbances. Cycle power to the system to attempt clearing the error.

#### RTS

The green RTS LED indicates the GS-EDRV is ready to send information to the AC drive.

#### TXD

The green TXD LED flashes to indicate that the card sees data traveling to the AC drive. During heavy communication loads, this LED will be steady ON.

#### RXD

The green RXD LED flashes to indicate that the card sees data traveling from the AC drive. During heavy communication loads this LED will be steady ON.

## Setting the GS-EDRV Address

Each GS-EDRV must have an identification (ID) or address in order to be recognized on the network, and each ID must be unique.



**WARNING:** Duplicate IDs on the same network will cause unpredictable results and must be avoided.

### Setting Module ID with DIP Switches

You can use the DIP switch to set the ID to a number from one to sixty-three. Do not use ID "0" for communication.

**If the DIP switch is set to a number greater than 0, the software tools are disabled from setting the ID. Again, the software tools will only allow changes to the ID if the DIP switch setting is 0 (zero, all switches OFF).**



*The DIP switch settings are read only at power-up. You must cycle power if you change the DIP switches.*

The GS-EDRV contains eight individual DIP switches, but only six of these are active. You will find that the switches on the printed circuit board are labeled 0 through 7. The numbers on the printed circuit board indicate the power of 2 represented by each individual switch. For example, switch 0 represents  $2^0$  (or 1), switch 1 is  $2^1$  (or 2), switch 2 is  $2^2$  (or 4), and so on.

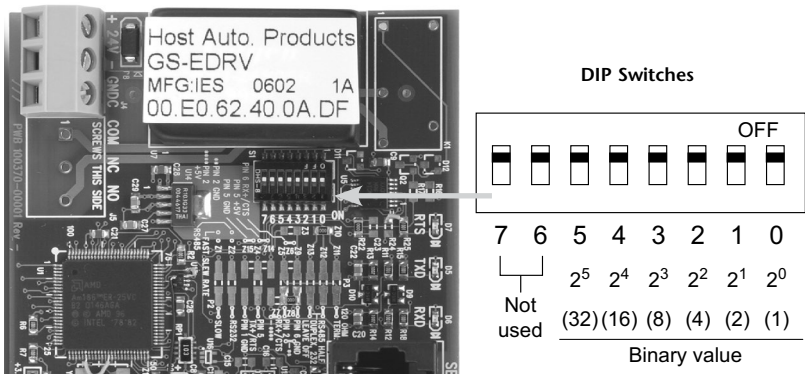

The ID equals the sum of the binary values of the slide switches set in the ON position. For example, if you set slide switches 1, 2, and 3 to the ON position, the ID will be 14. This is found by adding  $8+4+2=14$ . The maximum value you can set on the DIP switch is  $32+16+8+4+2+1=63$ . This is achieved by setting switches 0 through 5 to the ON position.



## Setting TCP/IP Address with NetEdit

NetEdit is a free utility that can be used to configure the GS-EDRV's IP address. This utility is included with the DirectSOFT software or it can be downloaded from <http://support.automationdirect.com/downloads.html>.

Connect your PC to the Ethernet network that the GS-EDRV is currently on and open the NetEdit utility. If it is not already selected, select the TCP/IP tab as seen below.

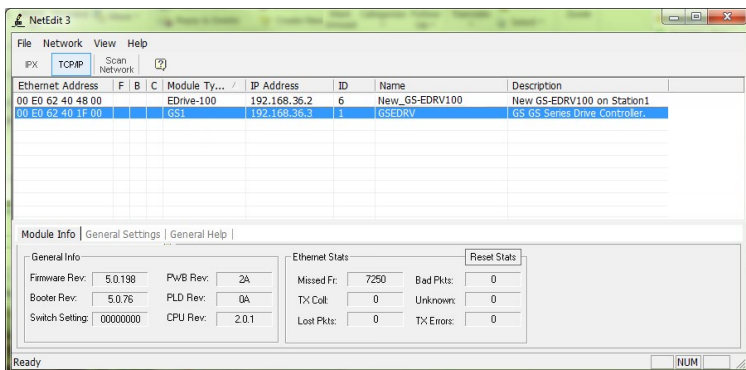

Double click on the desired GS-EDRV. A "General Settings" popup will display allowing you to configure the IP address of the module you have selected.



Press the OK button to write the new configuration to the GS-EDRV.

## GS-EDRV Network Connections

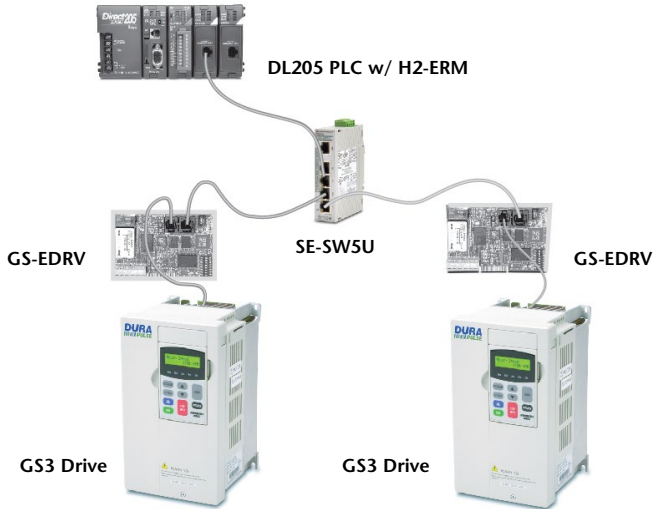

### 10Base-T Connections

The GS-EDRV Ethernet port has an eight-pin modular jack that accepts RJ45 connector plugs. UTP (Unshielded Twisted-Pair) cable is rated according to its data-carrying ability (bandwidth) and is given a “category” number. We strongly recommend using a category 5 cable for all Ethernet 10Base-T connections. For convenient and reliable networking, we recommend that you purchase commercially manufactured cables (cables with connectors already attached).

To connect an GS-EDRV (or PC) to a hub, switch, or repeater, use a patch cable (sometimes called a straight-through cable). The cable used to connect a PC or an H2(4)-ERM directly to an GS-EDRV or to connect two hubs is referred to as a crossover cable.

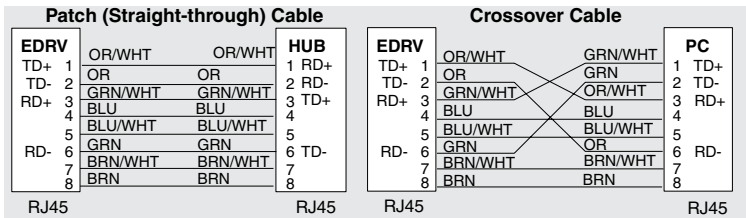

This diagram illustrates the standard wire positions in the RJ45 connector. We recommend all Ethernet 10BaseT cables to be Category 5, UTP cable.

## GS-EDRV100 Overview

The GS-EDRV100 provides a low cost, high-performance 10/100Mbps Ethernet link between a control system and a GS Series AC Drive. The control system can be any of the following:

- DL205 CPU, DL405 CPU, or a WinPLC, with the appropriate Ethernet Remote Master module (H2-ERM or H4-ERM).
- A Do-more CPU with an onboard Ethernet port.
- A Productivity3000 CPU using the onboard Ethernet port.
- A PC using a custom device driver that was developed using our Ethernet SDK.
- A PC running KEP*Direct* EBC or OPC Server.
- Any independent I/O controller with a Modbus TCP/IP driver.

The GS-EDRV100 has an encapsulated compact DIN rail mounted design allowing for minimal space requirements. With the appropriate cable connections and, if needed, Ethernet switches or hubs, the GS-EDRV100 will allow you to communicate with your AC drive over qualified Ethernet networks.

The functions of the interface are as follows:

- process input signals from the AC drive.
- format these signals to conform to the Ethernet standard.
- transmit converted signals to the control system.
- receive and translate output signals from the control system.
- sends the output signals to the drive.

The control function is NOT performed by the interface. The control function is performed by one of the control systems mentioned above. The I/O mapping function is performed by an H2(4)-ERM module (purchased separately). The H2(4)-ERM module is configured with the ERM Workbench Utility which is part of the *DirectSOFT* PLC programming software.

### Operation

Operation of the GS-EDRV100 is divided up into two communication networks:

1. Communication from the GS-EDRV100 to the drive.
2. Communication from a control device ( PLC, PC, etc..) to the GS-EDRV100

### GS-EDRV100 to AC Drive

The GS-EDRV100 will constantly try to read information from the variable frequency drive. It reads all the parameters from the drive in blocks, so even if you are only interested in one parameter the GS-EDRV100 has to read all the parameters over the RS 485 network before that one parameter gets updated again. The network baud rate defaults to 19200 so this can take some time (typically around 600ms). This time can be affected by write commands from the control device. For instance if you try to write information to the drive every 100 ms this could actually slow down the time it takes the GS-EDRV100 to read the data from the drive as it will interrupt the read process between the GS-EDRV100 and the variable frequency drive. Increasing the rate of the read commands from

the control device will NOT speed up the time it takes for the GS-EDRV100 to read data from the drive. The only thing that will happen is the control device will read the same data more often.

### **Control Device to GS-EDRV100**

Communication between the control device and the GS-EDRV100 is for reading and writing data to the GS-EDRV100 so that the GS-EDRV100 can then write the data to the variable frequency drive. The GS-EDRV100 can be thought of as the gateway to the variable frequency drive in that it holds all the information read from the variable frequency drive that the control device wants to read and writes all the information from the control device to the variable frequency drive when it is asked to do so by the control device. This network is ethernet and much faster than serial, so it can read the data being held in the GS-EDRV100 many times before the data in the GS-EDRV100 gets updated information from the variable frequency drive.

Adding a GS-EDRV100 may not necessarily speed up your update performance. If you are only controlling 1 or 2 drives it may be faster to control them directly on RS-485 communications if your control device has that capability. However if you are controlling many drives using the GS-EDRV100 would increase performance since the Ethernet Protocol can allow for concurrent requests to multiple GS-EDRV100s simultaneously versus serial which could only send one request at a time.

### Package Contents

After receiving the GS-EDRV100, please check for the following:

- Make sure that the part number indicated on the package corresponds with the part number of your order.
- Make sure that the package includes a GS AC Drive Ethernet Interface card (GS-EDRV100), one DIN rail mounting clip, one 3-wire terminal block, and one serial connection cable (2ft in length).
- Inspect the contents to insure they were not damaged during shipment.



## GS-EDRV100 Layout

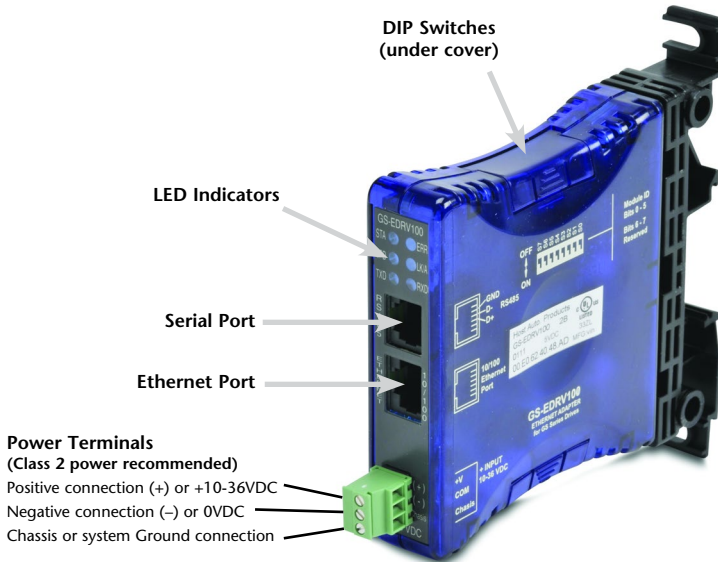

### Power Terminals

(Class 2 power recommended)

Positive connection (+) or +10-36VDC

Negative connection (-) or 0VDC

Chassis or system Ground connection

### Power Terminals

Power for the GS-EDRV100 is connected directly to the card using a 10-36VDC power supply (a Class 2 power supply is recommended). The Chassis terminal is for a chassis or system ground.

### Input Current and Voltage Ratings

220mA@10VDC, 70mA@24VDC, or 50mA@36VDC.

### Communication Ports

Two comm ports are provided to make the connection from a GS Series AC drive (Serial port) to an Ethernet device or network (Ethernet port).

### DIP Switches

The DIP Switches are used to set the Module ID for the GS-EDRV100 card.

### LED Indicators

#### STA

The STA or STATUS LED is steady ON when the GS-EDRV100 is connected to a GS Series AC drive and communication has been established.

#### SPD

The SPD or SPEED LED is used to represent the Ethernet speed. The LED will be ON when the Ethernet speed is 100Mbps and OFF when the speed is 10Mbps.

#### TXD

The TXD or TRANSMIT DATA LED flashes to indicate that the GS-EDRV100 is sending data through the serial port to the AC drive.

#### ERR

If the GS-EDRV100's ERR (ERROR) indicator is ON, a critical error has occurred. The error may be in the card itself, or a network problem may be causing this symptom. The ERROR indication can be caused by a faulty ground, an electrical spike or other types of electrical disturbances. Cycle power to the system to attempt clearing the error. The ERROR LED will also flash (once per second) when a firmware update is in progress.

#### LK/A

The LK/A or LINK GOOD/ACTIVITY LED flashes to indicate that the card sees data traveling on the Ethernet network. If any network device is sending or receiving data, the LK/A LED will be flashing. During heavy communication loads, this indicator will be steady ON. If the LED is OFF, then a problem with the Ethernet connection has been detected.

#### RXD

The RXD or RECEIVE DATA LED flashes to indicate that the GS-EDRV100 is receiving data through the serial port from the AC drive.

## Setting the GS-EDRV100 Address

Each GS-EDRV100 must have an identification (ID) or address in order to be recognized on the network, and each ID must be unique.



**WARNING: Duplicate IDs on the same network will cause unpredictable results and must be avoided.**

### Setting Module ID with DIP Switches

You can use the DIP switch to set the ID to a number from one to sixty-three. Do not use ID "0" for communication.

**If the DIP switch is set to a number greater than 0, the software tools are disabled from setting the ID. Again, the software tools will only allow changes to the ID if the DIP switch setting is 0 (zero, all switches OFF).**



*The DIP switch settings are read only at power-up. You must cycle power if you change the DIP switches.*

The GS-EDRV100 contains eight individual DIP switches, but only six of these are active. You will find that the switches on the printed circuit board are labeled 0 (zero) through 7. The numbers on the printed circuit board indicate the power of 2 represented by each individual switch. For example, switch 0 represents  $2^0$  (or 1), switch 1 is  $2^1$  (or 2), switch 2 is  $2^2$  (or 4), and so on.

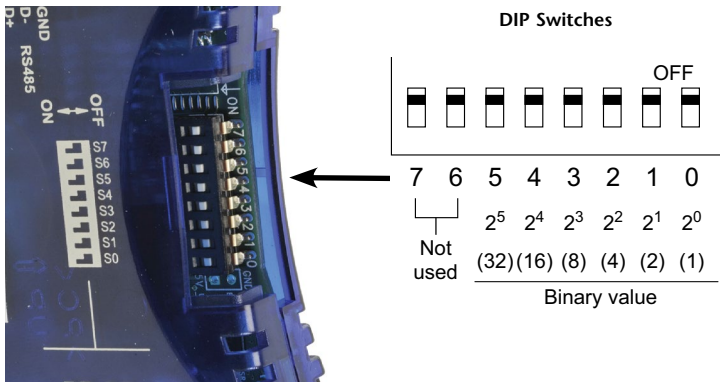

The ID equals the sum of the binary values of the slide switches set in the ON position. For example, if you set slide switches 1, 2, and 3 to the ON position, the ID will be 14. This is found by adding  $8+4+2=14$ . The maximum value you can set on the DIP switch is  $32+16+8+4+2+1=63$ . This is achieved by setting switches 0 through 5 to the ON position.



## Setting TCP/IP Address with NetEdit

NetEdit is a free utility that can be used to configure the GS-EDRV100's IP address. This utility is included with the DirectSOFT software or it can be downloaded from <http://support.automationdirect.com/downloads.html>.

Connect your PC to the Ethernet network that the GS-EDRV100 is currently on and open the NetEdit utility. If it is not already selected, select the TCP/IP tab as seen below.

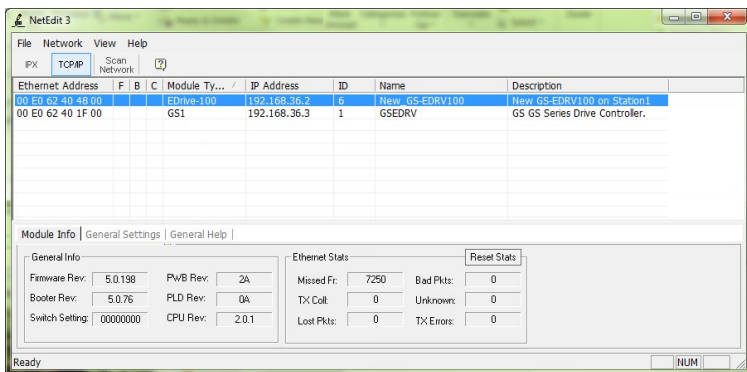

Double click on the desired GS-EDRV100. A “General Settings” popup will display allowing you to configure the IP address of the module you have selected.

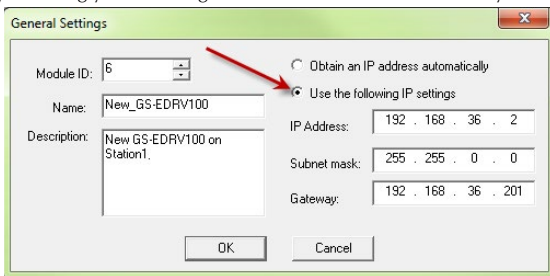

Press the OK button to write the new configuration to the GS-EDRV100.

## GS-EDRV100 Network Connections



### 10/100Mbps Connections

The GS-EDRV100 Ethernet port has an eight-pin modular jack that accepts RJ45 connector plugs. UTP (Unshielded Twisted-Pair) cable is rated according to its data-carrying ability (bandwidth) and is given a “category” number. We strongly recommend using a category 5 cable for all Ethernet 10/100Mbps connections. For convenient and reliable networking, we recommend that you purchase commercially manufactured cables (cables with connectors already attached).

To connect an GS-EDRV100 (or PC) to a hub, switch, or repeater, use a patch cable (sometimes called a straight-through cable). The cable used to connect a PC or an H2(4)-ERM directly to an GS-EDRV100 or to connect two hubs is referred to as a crossover cable.

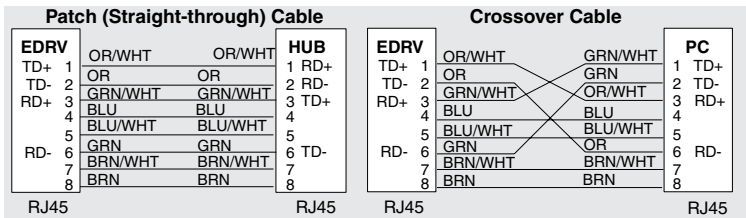

This diagram illustrates the standard wire positions in the RJ45 connector. We recommend all Ethernet 10/100Mbps cables to be Category 5, UTP cable.

## GS-EDRV(100) to GS Series AC Drive Connection

A serial connection cable (2ft. in length) is provided with the GS-EDRV(100) to make an RS-485 connection with a GS Series AC Drive.



When using the **GS2 Series AC Drive**, DIP Switch 2 and 3 (SW2 and SW3) on the drive must be set to RS485.



Switches SW2 and SW3 on the drive must be set to RS485 for an RS-485 connection (GS2 Series Only).

### Setting the GS Series AC Drive Parameters

The following parameters need to be set in the GS Series AC Drive in order to operate properly with the GS-EDRV(100) interface card.

P3.00: 03 or 04 – Operation Determined by RS232C/RS485 interface. Keypad STOP is enabled (03) or disabled (04).

P4.00: 05 – Frequency determined by RS232/RS485 communication interface

P9.00: 01 – Must be set to 1 in order for the EDRV to communicate to the GS drive

**NOTE:**

*P9.01 will be automatically changed to a value of 2 (19200 baud) by the EDRV, and it cannot be changed to anything else.*

*P9.02 will be automatically changed to a value of 5 (Modbus RTU mode <8 data bits, odd parity, 1 stop bit>) by the EDRV, and it cannot be changed to anything else*



The previous list of parameter settings is the minimum required to communicate with a GS Series AC Drive through a GS-EDRV(100) interface card. There may be other parameters that need to be set to meet the needs of your application.

## GS-EDRV(100) to ERM Module Connection

The GS-EDRV(100) interface card can be added to any H2(4)-ERM module using the ERM Workbench Utility. For more details on selecting and configuring slaves for the ERM module, see CHAPTER 4 of the H24-ERM-M.

### Reserved PLC Memory for the GS-EDRV(100)

Once the GS-EDRV(100) is added the ERM module, 16 WORD inputs and 11 WORD outputs are mapped back to the PLC. The assigned PLC addresses are shown in the ERM Workbench Utility.

Ethernet Remote Master: H2-ERM Ethernet Address: 00 E0 62 20 0F 9E IP: 192.168. 26.101 Module ID: 101

CPU Interface: PLC CPU: 260 PLC Mode: Program

Last ERM Error: no error

Time of last read: 16:45:41

Slave Status

Click on slave # above to see its Last Error:

Slave 1 - no error

Clear Last Error Slave 1 Slave 1's Error List

I/O Module	I/O Points	PLC Start	PLC End	V-Map	Notes
<reserved>	Slave Status Bits	X300	X317	V40414	
	ERM Status Word	X320	X337	V40415	
	Disable Slave Comm...	Y300	Y317	V40514	
Slave 1	GS-EDRV				Ethernet Address[00 E0 62 40 00 11] on IPX;
Slave 1/Slot 0	4 Word Input	V2000	V2003		16-bit Binary;
Slave 1/Slot 1	10 Word Input	V2004	V2015		16-bit Binary;
Slave 1/Slot 2	2 Word Input	V2016	V2017		16-bit Binary;
Slave 1/Slot 3	4 Word Output	V2100	V2103		16-bit Binary;
Slave 1/Slot 4	5 Word Output	V2104	V2110		16-bit Binary;
Slave 1/Slot 5	2 Word Output	V2111	V2112		16-bit Binary;

16 Input WORDS

11 Output WORDS

## Reading/Writing From/To the Drive



---

*The control function is NOT performed by the interface. The control function is performed by the control system. The I/O mapping function is performed by an H2(4)-ERM module (purchased separately). The H2(4)-ERM module is configured with the ERM Workbench Utility which is part of the DirectSOFT PLC programming software.*

---

### Input/Output Word Map

The Input and Output WORDS for the GS-EDRV(100) are mapped to specific parameters and functions in the GS Series AC Drives. The Word Map tables on the following pages show the Input and Output WORDS and their functions.

### Using the Input/Output Words

Output Words 10 and 11 are used in conjunction with Input Words 15 and 16 to Read/Write AC drive parameters that are not mapped to other Input and Output Words. By using Output Words 10 and 11 with Input Words 14 and 15, you have the ability to read/write most AC drive parameters.



---

*P9.29 is the only Communication Parameter (P9.xx range) that can be written to using the Read/Write Input/Output Words (IW 15 & 16; OW 10 & 11). However, these Input/Output Words can be used to read values from all of the drive Communication Parameters (P9.xx range).*

---

## Input Word Map

Input WORD Map		
Input Word	Parameter Reference	Function
1	N/A	Present Output Frequency
2	N/A	Present Output Current
3	Drive P9.29 & EDRV Comm Fault Bit	Bit 0 = Drive Serial Comm External Fault bit (P9.29) Bit 1 = EDRV internal EDRV-to-Drive Comm Fault bit  00 = 0: no EDRV-to-drive comm fault; no manual comm ext fault 01 = 1: no EDRV-to-drive comm fault; manual comm ext fault triggered 10 = 2: EDRV-to-drive comm fault; no manual comm ext fault 11 = 3: EDRV-to-drive comm fault; manual comm ext fault triggered
4	P6.31	P6.31 = Status Monitor 1 – Error Codes from AC Drive.  00: No fault occurred 01: Over-current(oc) 02: Over-voltage(ov) 03: Overheat (oH) 04: Overload (oL) 05: Overload 1 (oL1) 06: Overload 2 (oL2) 07: External Fault (EF) 08: CPU failure 1 (CF1) 09: CPU failure 2 (CF2) 10: CPU failure 3 (CF3) 11: Hardware Protection Failure (HPF) 12: Over-current during accel (OCA) 13: Over-current during decel (Ocd) 14: Over-current during steady state (Ocd) 15: Ground fault or fuse failure (GFF) 16: Low voltage (Lv) 17: Input power 3-phase loss 18: External Base-Block (bb) 19: Auto adjust accel/decel failure (cFA) 20: Software protection code (codE)
5	P9.16	Block Transfer Parameter 6 – User defined read value
6	P9.17	Block Transfer Parameter 7 – User defined read value
7	P9.18	Block Transfer Parameter 8 – User defined read value
8	P9.19	Block Transfer Parameter 9 – User defined read value
9	P9.20	Block Transfer Parameter 10 – User defined read value
10	P9.21	Block Transfer Parameter 11 – User defined read value
11	P9.22	Block Transfer Parameter 12 – User defined read value
12	P9.23	Block Transfer Parameter 13 – User defined read value
13	P9.24	Block Transfer Parameter 14 – User defined read value
14	P9.25	Block Transfer Parameter 15 – User defined read value
<i>Table continued next page.</i>		

## Input Word Map (continued)

Input WORD Map (continued)																		
Input Word	Parameter Reference	Function																
15	Read/Write Response	<p>Response to a read/write request (Output Word 10)</p> <p>Bit: 00-07 = Memory Reference            08-11 = Memory type number (i.e. 0 to A for P0 to P10)            12-13 = Operation (works in conjunction with bit 15):            0=NOP, 9=Read accomplished, A=Write accomplished</p> <p>Bit 12 set indicates a read operation.            Bit 13 set indicates a write operation.            Bit 15 set indicates the read or write op was accomplished.            Check bit 14 and Input Word 16 to see if an error occurred.</p> <p>14 = Error status:            If set, an error has occurred. Error Code is stored in Word 16.</p> <p>15 = Read/Write Status:            If set, the read or write operation was successful.</p>																
16	Read Request Value	<p>If Input Word 15 is a Read response, the value is stored here.            If Input Word 15 is an Error response, the error code is stored here.</p> <p>Error Codes:</p> <table border="0"> <tr> <td>0x8010</td> <td>HEIE_INVALID_REQUEST</td> </tr> <tr> <td>0x8090</td> <td>HEIE_NOT_INITIALIZED</td> </tr> <tr> <td>0x8096</td> <td>HEIE_INVALID_OPERATION</td> </tr> <tr> <td>0x006F</td> <td>HEIE_INVALID_TYPE</td> </tr> <tr> <td>0x0091</td> <td>HEIE_INVALID_MODE</td> </tr> <tr> <td>0x008C</td> <td>HEIE_INVALID_ADDRESS</td> </tr> <tr> <td>0x0085</td> <td>HEIE_RANGE_ERROR</td> </tr> <tr> <td>0x006D</td> <td>HEIE_SIZE_ERROR</td> </tr> </table>	0x8010	HEIE_INVALID_REQUEST	0x8090	HEIE_NOT_INITIALIZED	0x8096	HEIE_INVALID_OPERATION	0x006F	HEIE_INVALID_TYPE	0x0091	HEIE_INVALID_MODE	0x008C	HEIE_INVALID_ADDRESS	0x0085	HEIE_RANGE_ERROR	0x006D	HEIE_SIZE_ERROR
0x8010	HEIE_INVALID_REQUEST																	
0x8090	HEIE_NOT_INITIALIZED																	
0x8096	HEIE_INVALID_OPERATION																	
0x006F	HEIE_INVALID_TYPE																	
0x0091	HEIE_INVALID_MODE																	
0x008C	HEIE_INVALID_ADDRESS																	
0x0085	HEIE_RANGE_ERROR																	
0x006D	HEIE_SIZE_ERROR																	

## Output Word Map

Output WORD Map		
Output Word	Parameter Reference	Function
1	P9.27	RUN Command
2	P9.26	RS-485 Speed Reference
3	P9.28	Direction Command (0 = Forward; 1 = Reverse)
4	P9.30	Serial Comm Fault Reset (0 = no action; 1 = Reset Fault)
5	P9.11	Block Transfer Parameter 1 – user defined write value
6	P9.12	Block Transfer Parameter 2 – user defined write value
7	P9.13	Block Transfer Parameter 3 – user defined write value
8	P9.14	Block Transfer Parameter 4 – user defined write value
9	P9.15	Block Transfer Parameter 5 – user defined write value
10	Read/Write Request	<p>Bit: 00-07 = Memory Reference            08-11 = Memory type number (i.e. 0 to A for P0 to P10)            12-13 = Operation: 00=NOP, 01=Read, 10=Write, 11=Undefined            14 = Undefined for request</p>
11	Write Request Value	If Output Word 10 is a Write request, the value to be written is placed here.

## Examples – I/O Word Mapping

- 1) Read P9.29 (Serial Comm External Fault):

Write value 0x191D into Output Word 10, and the parameter address 0x991D will come back into Input Word 15. The value read from P9.29 will be stored in Input Word 16.

OW 10: Read Request: Read from drive parameter 9.29																
		n/a	operation	parameter group #				parameter memory reference #								
Bit #	15	14	13	12	11	10	9	8	7	6	5	4	3	2	1	0
Binary #	0	n/a	0	1	1	0	0	1	0	0	0	1	1	1	0	1
Hex #	0	n/a	1	9				1				D				
Decimal #	0	n/a	1	9				29								
Meaning	n/a	n/a	read	parameter 9.29												

IW 15: Read Response: Read from drive parameter 9.29																
	status	error	operation	parameter group #				parameter memory reference #								
Bit #	15	14	13	12	11	10	9	8	7	6	5	4	3	2	1	0
Binary #	1	0	0	1	1	0	0	1	0	0	0	1	1	1	0	1
Hex #	9			9				1				D				
Decimal #	9			9				29								
Meaning	successful		read	parameter 9.29												

- 2) Write to P9.29 (Serial Comm External Fault):

Write value 0x291D into Output Word 10, and the parameter address 0xA91D will come back into Input Word 15. The value in Output Word 11 will be written to drive P9.29.

OW 10: Write Request: Write to drive parameter 9.29																
		n/a	operation	parameter group #				parameter memory reference #								
Bit #	15	14	13	12	11	10	9	8	7	6	5	4	3	2	1	0
Binary #	0	n/a	1	0	1	0	0	1	0	0	0	1	1	1	0	1
Hex #	0	n/a	2	9				1				D				
Decimal #	0	n/a	2	9				29								
Meaning	n/a	n/a	write	parameter 9.29												

IW 15: Write Response: Write to drive parameter 9.29																
	status	error	operation	parameter group #				parameter memory reference #								
Bit #	15	14	13	12	11	10	9	8	7	6	5	4	3	2	1	0
Binary #	1	0	1	0	1	0	0	1	0	0	0	1	1	1	0	1
Hex #	A			9				1				D				
Decimal #	10			9				29								
Meaning	successful		write	parameter 9.29												



**Examples – I/O Word Mapping (continued)**

3) Read P0.00 (Motor Nameplate Voltage):

Write value 0x1000 into Output Word 10, and the parameter address 0x9000 will come back into Input Word 15. The value read from P0.00 will be stored in Input Word 16.

OW 10: Read Request: Read from drive parameter 0.00																
	n/a			operation				parameter group #				parameter memory reference #				
Bit #	15	14	13	12	11	10	9	8	7	6	5	4	3	2	1	0
Binary #	0	n/a	0	1	0	0	0	0	0	0	0	0	0	0	0	0
Hex #	0	n/a	1		0				0				0			
Decimal #	0	n/a	1		0				0				0			
Meaning	n/a	n/a	read		parameter 0.00											

IW 15: Read Response: Read from drive parameter 0.00																
	status	error	operation				parameter group #				parameter memory reference #					
Bit #	15	14	13	12	11	10	9	8	7	6	5	4	3	2	1	0
Binary #	1	0	0	1	0	0	0	0	0	0	0	0	0	0	0	0
Hex #	9			0				0				0				
Decimal #	9			0				0				0				
Meaning	successful		read		parameter 0.00											

## Built-in Web Server

The GS-EDRV(100) interface card has a built-in Web Server that allows you to access AC drive data with your favorite Web browser. In order to access the internal Web Server, you must first assign an IP address to the GS-EDRV(100) card. The IP address can be assigned by using the NetEdit utility. You can then access the GS-EDRV(100) card by typing the IP address into your Web browser.

### Example

If the IP address of your GS-EDRV100 is 192.168.36.2, just enter **http://192.168.36.2** into the address field of your browser and press the **Enter** key.

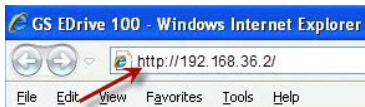

The browser will then access the built-in Web Server as seen below. The available parameter groups are shown with links to the parameter options.

### EDrive-100 by [Automation Direct.com](http://www.automation-direct.com)

Module ID:	<a href="#">6 (0x6)</a>
Module Name:	<a href="#">New GS-EDRV100</a>
Module Description:	<a href="#">New GS-EDRV100 on Station1, Drive 6</a>
Ethernet Address:	<a href="#">00 E0 62 40 48 00</a>
IP Setup:	<a href="#">Address: 192.168.36.2</a> <a href="#">Subnet: 255.255.0.0</a> <a href="#">Gateway: 192.168.36.201(Supplied by DHCP)</a>
Booter Version:	<a href="#">5.0.76</a>
OS Version:	<a href="#">5.0.198</a>
Comm Link:	<a href="#">Searching for drive.</a>
P0	<a href="#">Monitoring parms</a>
P1	<a href="#">Ramps parms</a>
P2	<a href="#">Volts/Hertz parms</a>
P3	<a href="#">Digital parms</a>
P4	<a href="#">Analog parms</a>
P5	<a href="#">Presets parms</a>
P6	<a href="#">Protection parms</a>
P7	<a href="#">PID parms</a>
P8	<a href="#">Display parms</a>
P9	<a href="#">Comm parms</a>
P10	<a href="#">Encoder Feedback parms</a>
Firmware Updates:	<a href="#">Hosteng.com</a>

## Troubleshooting – H24-ERM-M

### Refer to Ethernet Remote Master User Manual H24-ERM-M

Troubleshooting help for the ERM module and its slaves is available in CHAPTER 6 of the Ethernet Remote Master User Manual (H24-ERM-M).

## Application Example: Modbus TCP/IP

This application example shows how to use a GS-EDRV(100) to access a GS1, GS2 or a DURApulse drive's parameters for monitoring and control via the Modbus TCP/IP protocol.

Equipment and software used in example:

- Two DURApulse Drives
- Two GS-EDRV100 Ethernet interface modules
- A Stride Ethernet switch (SE-SW5U-ST)
- A standard network PC with a Modbus TCP/IP driver installed
- ModScan software (available for download from Win-Tech at <http://www.win-tech.com/html/demos.htm>), or any other Modbus TCP/IP interfacing software

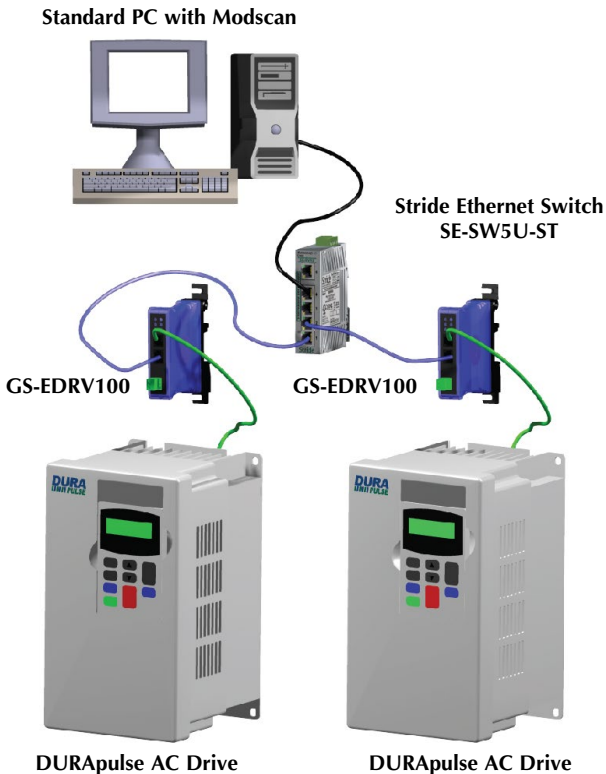

To monitor drive parameters using ModScan, set up the connection parameters as follows:

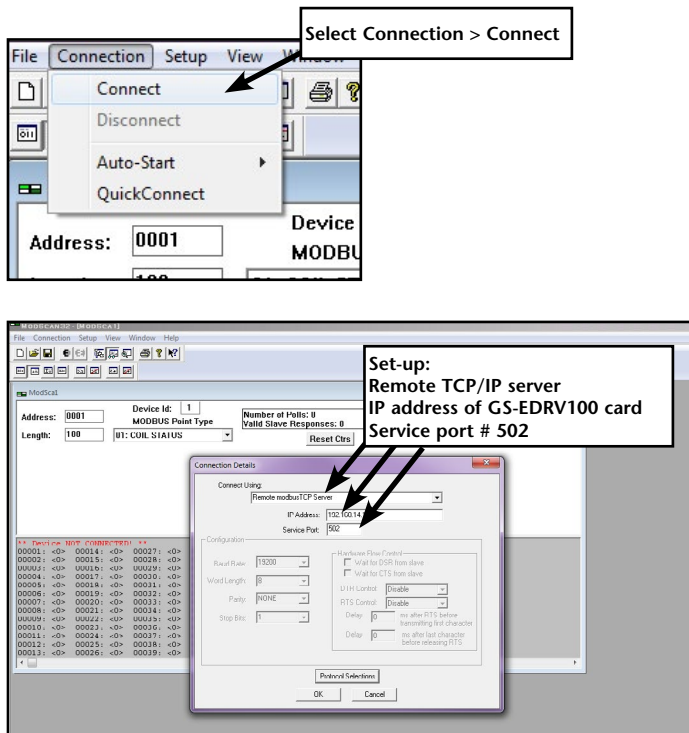

Once a connection to the interface has been established, select the drive parameters that you wish to monitor. See the table below for drive parameters and their modbus addresses.

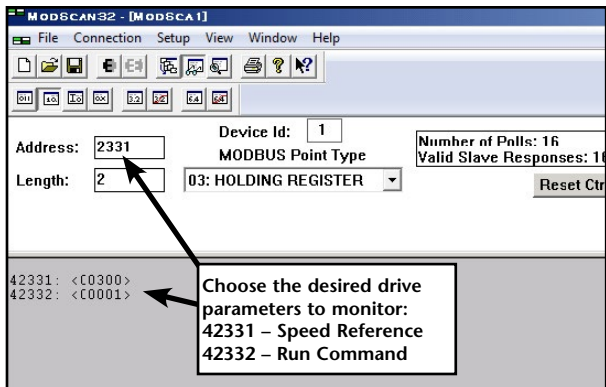

If you wish to write a value to the drive from this page, double click the address you wish to change and a Write Register window will appear. Enter the new value and select Update.

Modbus Addresses		
Read/Write	Hex	Modbus
Speed reference	091AH	42331
Run command	091BH	42332
Direction	091CH	42333
External fault	091DH	42334
Fault reset	091EH	42335
Jog	091FH	42336
Status	2101H	48450
Frequency command	2102H	48451
Output frequency	2103H	48452
Output current	2104H	48453
DC bus voltage	2105H	48454
Output voltage	1206H	48455
Motor RPM	2107H	48456
Scale frequency (low)	2108H	48457
Scale frequency (high)	2109H	48458
Percent load	210BH	48460
Firmware version	2110H	48465

ModScan gives you the ability to build custom interface forms (like the one below) that can be used to display and control GS/DURApulse drive parameters.

Custom Form			
GS3-43PO	Default	New	Comments
P0.00	480	460	Motor nameplate voltage setting
P0.01	5	4.8	Motor nameplate amps setting
P0.02	60	60	Motor base frequency
P0.03	1750	1725	Motor base RPM
P0.04	1750	1725	Motor maximum RPM
P1.00	0	1	Coast to stop
P1.01	10	20	Acceleration time
P2.00	0	2	Volts/hertz set to fans and pumps
P3.00	0	3	RS485 operation control enabled
P4.00	0	5	RS485 speed reference control
P8.00	0	3	RPM display
P9.00	1	X (1)	Communication address (dependent on drive 1-8)
P9.01	1	1	9600 baud rate
P9.02	0	5	Modbus RTU 8 data bits, odd parity, 1 stop bit

To build a new form, select **File>Custom Form>Create** and a blank form will open. With your mouse, select an area of the form and a Custom Display menu will appear as seen below.

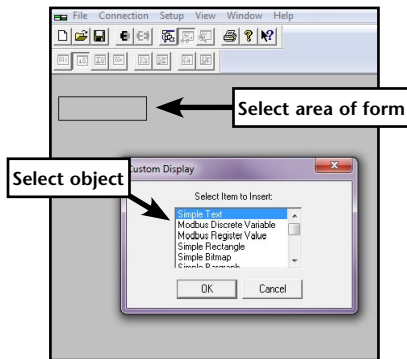

Select an object (text, charts, shapes or data) from the menu and ModScan will load the selection into the form. When creating data objects, such as Register and Discrete variables, selecting the Write Enabled checkbox (as seen on following page) will allow the user to write values out to the drive from this f

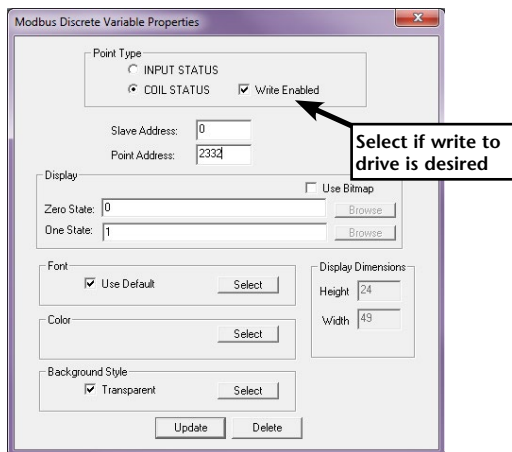

Once a read/write data object is created, double click on the object and a Write Modbus Variable popup will appear allowing the user to enter a new value for the selected parameter.

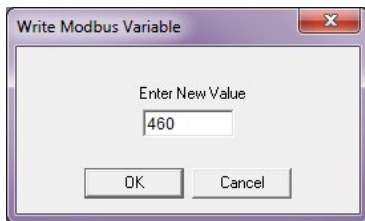

Enter the new value and select OK to write the new value to the drive.