

Operating Instructions

Ceraphant PTC31B, PTP31B, PTP33B

IO-Link

Process pressure measurement
Pressure switch for safe measurement and monitoring of
absolute and gauge pressure

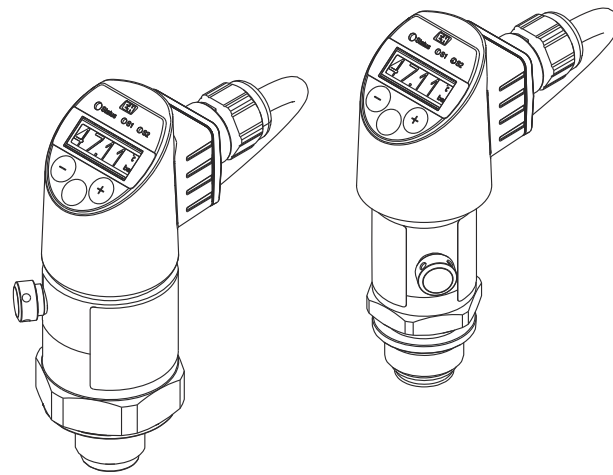
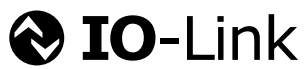



A0023555

- Make sure the document is stored in a safe place such that it is always available when working on or with the device.
- To avoid danger to individuals or the facility, read the "Basic safety instructions" section carefully, as well as all other safety instructions in the document that are specific to working procedures.
- The manufacturer reserves the right to modify technical data without prior notice. Your Endress+Hauser distributor will supply you with current information and updates to this manual.

Table of contents

1	About this document	5	8	System integration	31
1.1	Document function	5	8.1	Process data	31
1.2	Symbols used	5	8.2	Reading out and writing device data (ISDU – Indexed Service Data Unit)	32
1.3	Documentation	6	9	Commissioning	39
1.4	Terms and abbreviations	7	9.1	Function check	39
1.5	Turn down calculation	7	9.2	Commissioning with an operating menu	39
1.6	Registered trademarks	8	9.3	Configuring pressure measurement	40
2	Basic safety instructions	9	9.4	Performing position adjustment	42
2.1	Requirements concerning the staff	9	9.5	Configuring process monitoring	44
2.2	Intended use	9	9.6	Current output	45
2.3	Workplace safety	10	9.7	Application examples	47
2.4	Operational safety	10	10	Diagnosis and troubleshooting	48
2.5	Product safety	10	10.1	Troubleshooting	48
3	Product description	11	10.2	Diagnostic events	49
3.1	Product design	11	10.3	Behavior of the device in the event of a fault ..	51
3.2	Operating principle	11	10.4	Signal on alarm 4 to 20 mA	52
4	Incoming acceptance and product identification	13	10.5	Behavior of the device in the event of a voltage drop	52
4.1	Incoming acceptance	13	10.6	Behavior of the device in the event of an incorrect entry	53
4.2	Product identification	14	10.7	Resetting to factory settings (reset)	53
4.3	Storage and transport	14	11	Maintenance	53
5	Mounting	16	11.1	Exterior cleaning	53
5.1	Installation conditions	16	12	Repair	54
5.2	Influence of orientation	16	12.1	General notes	54
5.3	Mounting location	17	12.2	Return	54
5.4	Mounting instructions for oxygen applications	19	12.3	Disposal	54
5.5	Post-mounting check	19	13	Overview of the onsite display operating menu	55
6	Electrical connection	20	13.1	Without Smart Sensor Profile	55
6.1	Connecting the measuring unit	20	13.2	With Smart Sensor Profile	57
6.2	Connection data	22	14	Overview of the IO-Link operating menu	60
6.3	Post-connection check	23	14.1	Without Smart Sensor Profile	60
7	Operation options	24	14.2	With Smart Sensor Profile	61
7.1	Operation with operating menu	24	15	Description of device parameters ...	63
7.2	Operation with local display	25	15.1	Identification	63
7.3	General value adjustment and rejection of illegal entries	26	15.2	Diagnosis	64
7.4	Navigation and selection from list	26	15.3	Parameter	66
7.5	Locking and unlocking operation	28	15.4	Observation	83
7.6	Navigation examples	30			
7.7	Status LEDs	30			
7.8	Resetting to factory settings (reset)	30			

16	Accessories	84
16.1	Weld-in adapter	84
16.2	Process adapter M24	84
16.3	Flush mount pipe connections M24	84
16.4	M12 plug-in jack	85
Index	86

1 About this document

1.1 Document function

These Operating Instructions contain all the information required in the various life cycle phases of the device: from product identification, incoming acceptance and storage, to installation, connection, operation and commissioning, through to troubleshooting, maintenance and disposal.

1.2 Symbols used

1.2.1 Safety symbols

DANGER

This symbol alerts you to a dangerous situation. Failure to avoid this situation will result in serious or fatal injury.

WARNING

This symbol alerts you to a dangerous situation. Failure to avoid this situation can result in serious or fatal injury.

CAUTION

This symbol alerts you to a dangerous situation. Failure to avoid this situation can result in minor or medium injury.

NOTICE

This symbol contains information on procedures and other facts which do not result in personal injury.

1.2.2 Electrical symbols

 Protective earth (PE)

Ground terminals, which must be grounded prior to establishing any other connections. The ground terminals are located on the inside and outside of the device.

 Ground connection

Grounded clamp, which is grounded via a grounding system.

1.2.3 Tool symbols

 Open-ended wrench

1.2.4 Symbols for certain types of information

 Permitted

Procedures, processes or actions that are permitted.

 Forbidden

Procedures, processes or actions that are forbidden.

 Tip

Indicates additional information

 Reference to documentation

 Series of steps

Reference to page: 

Result of an individual step: 

1.2.5 Symbols in graphics

A, B, C ... [View](#)

1, 2, 3 ... [Item numbers](#)

[1](#), [2](#), [3](#) [Series of steps](#)

1.3 Documentation

The following document types are available in the Downloads area of the Endress+Hauser website (www.endress.com/downloads):

 For an overview of the scope of the associated Technical Documentation, refer to the following:

- *Device Viewer* (www.endress.com/deviceviewer): Enter the serial number from the nameplate
- *Endress+Hauser Operations app*: Enter serial number from nameplate or scan matrix code on nameplate.

1.3.1 Technical Information (TI)

Planning aid

The document contains all the technical data on the device and provides an overview of the accessories and other products that can be ordered for the device.

1.3.2 Brief Operating Instructions (KA)

Guide that takes you quickly to the 1st measured value

The Brief Operating Instructions contain all the essential information from incoming acceptance to initial commissioning.

1.4 Terms and abbreviations

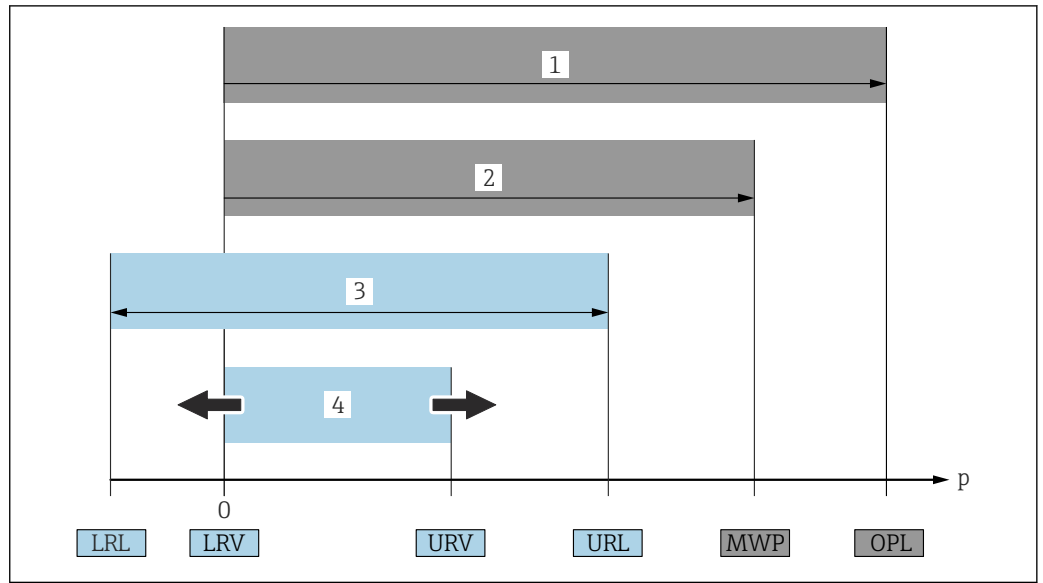

- 1 OPL: The OPL (over pressure limit = sensor overload limit) for the measuring device depends on the lowest-rated element, with regard to pressure, of the selected components, i.e. the process connection has to be taken into consideration in addition to the measuring cell. Observe pressure-temperature dependency. The OPL may only be applied for a short period of time.
 - 2 MWP: The MWP (maximum working pressure) for the sensors depends on the lowest-rated element, with regard to pressure, of the selected components, i.e. the process connection has to be taken into consideration in addition to the measuring cell. Observe pressure-temperature dependency. The maximum working pressure may be applied at the device for an unlimited period. The MWP can be found on the nameplate.
 - 3 The maximum sensor measuring range corresponds to the span between the LRL and URL. This sensor measuring range is equivalent to the maximum calibratable/adjustable span.
 - 4 The calibrated/adjusted span corresponds to the span between the LRV and URV. Factory setting: 0 to URL. Other calibrated spans can be ordered as customized spans.
- p Pressure
 LRL Lower range limit
 URL Upper range limit
 LRV Lower range value
 URV Upper range value
 TD Turn down. Example - see the following section.

1.5 Turn down calculation

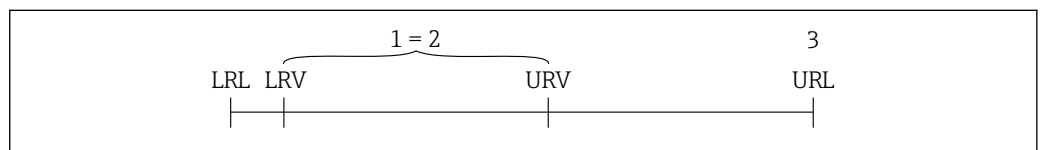

- 1 Calibrated/adjusted span
- 2 Zero point-based span
- 3 Upper range limit

Example:

- Measuring cell: 10 bar (150 psi)
- Upper range limit (URL) = 10 bar (150 psi)
- Calibrated/adjusted span: 0 to 5 bar (0 to 75 psi)
- Lower range value (LRV) = 0 bar (0 psi)
- Upper range value (URV) = 5 bar (75 psi)

$$\text{TD} = \frac{\text{URL}}{|\text{URV} - \text{LRV}|}$$

In this example, the TD is 2:1. This span is based on the zero point.

1.6 Registered trademarks

 **IO-Link**

is a registered trademark of the IO-Link Consortium.

2 Basic safety instructions

2.1 Requirements concerning the staff

The personnel for installation, commissioning, diagnostics and maintenance must fulfill the following requirements:

- ▶ Trained, qualified specialists: must have a relevant qualification for this specific function and task
- ▶ Are authorized by the plant owner/operator
- ▶ Are familiar with federal/national regulations
- ▶ Before beginning work, the specialist staff must have read and understood the instructions in the Operating Instructions and supplementary documentation as well as in the certificates (depending on the application)
- ▶ Following instructions and basic conditions

The operating personnel must fulfill the following requirements:

- ▶ Being instructed and authorized according to the requirements of the task by the facility's owner-operator
- ▶ Following the instructions in these Operating Instructions

2.2 Intended use

2.2.1 Application and media

The Ceraphant is a pressure switch for measuring and monitoring absolute and gauge pressure in industrial systems. The process-wetted materials of the measuring device must have an adequate level of resistance to the media.

The measuring device may be used for the following measurements (process variables)

- in compliance with the limit values specified under "Technical data"
- in compliance with the conditions that are listed in this manual.

Measured process variable

- Gauge and absolute pressure and hygienic applications
- Gauge pressure and absolute pressure

Calculated process variable

Pressure

2.2.2 Incorrect use

The manufacturer is not liable for damage caused by using the device incorrectly or for purposes for which it was not intended.

Clarification of borderline cases:

- ▶ With regard to special fluids and media used for cleaning, Endress+Hauser will be happy to assist in clarifying the corrosion-resistant properties of wetted materials but gives no guarantee or warranty as to the suitability of the materials.

2.2.3 Residual risks

When in operation, the housing may reach a temperature close to the process temperature.

Danger of burns from contact with surfaces!

- ▶ For elevated process temperatures, ensure protection against contact to prevent burns.

2.3 Workplace safety

When working on and with the device:

- ▶ Wear the required personal protective equipment as per national regulations.
- ▶ Switch off the supply voltage before connecting the device.

2.4 Operational safety

Risk of injury!

- ▶ Operate the device in proper technical condition and fail-safe condition only.
- ▶ The operator is responsible for interference-free operation of the device.

Conversions to the device

Unauthorized modifications to the device are not permitted and can lead to unforeseeable dangers.

- ▶ If, despite this, modifications are required, consult with Endress+Hauser.

Hazardous area

To eliminate the risk of danger to persons or the facility when the device is used in the approval-related area (e.g. pressure equipment safety):

- ▶ Check the nameplate to verify if the device ordered can be put to its intended use in the approval-related area.



2.5 Product safety

This device is designed in accordance with good engineering practice to meet state-of-the-art safety requirements, has been tested, and left the factory in a condition in which it is safe to operate.

It meets the general safety standards and legal requirements. It also complies with the EU directives listed in the device-specific EU Declaration of Conformity. Endress+Hauser confirms this by affixing the CE mark to the device.

3 Product description

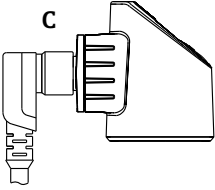
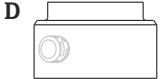
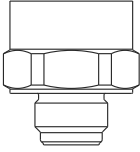
3.1 Product design

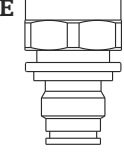
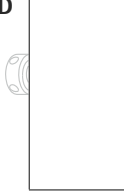
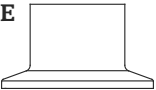
Overview of product design for IO-Link communication version	Item	Description
 <p style="text-align: right;">A0037238</p>	C	M12 plug Housing cap made of plastic
  <p style="text-align: right;">A0027226</p>	D E	Housing Process connection (sample illustration)
  <p style="text-align: right;">A0027215</p>	D E	
  <p style="text-align: right;">A0027227</p>	D E	

3.2 Operating principle

3.2.1 Calculating the pressure

Devices with ceramic process membrane (Ceraphire®)

The ceramic sensor is an oil-free sensor, i.e. the process pressure acts directly on the robust ceramic process membrane and causes it to deflect. A pressure-dependent change in capacitance is measured at the electrodes of the ceramic substrate and the process

membrane. The measuring range is determined by the thickness of the ceramic process membrane.

Devices with metallic process membrane

The process pressure deflects the metal process isolating diaphragm of the sensor and a fill fluid transfers the pressure to a Wheatstone bridge (semiconductor technology). The pressure-dependent change in the bridge output voltage is measured and evaluated.

4 Incoming acceptance and product identification

4.1 Incoming acceptance

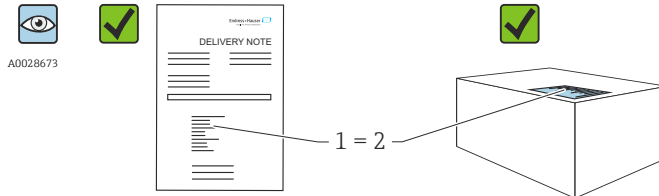

A0016870

Is the order code on the delivery note (1) identical to the order code on the product sticker (2)?

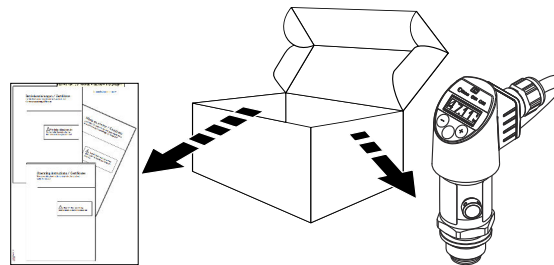

A0022099

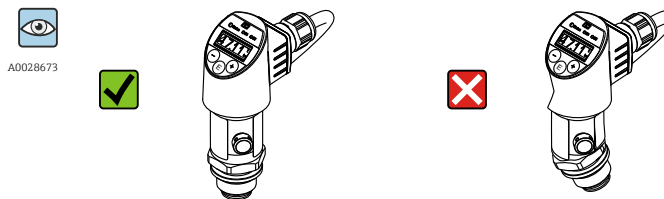

A0022101

Are the goods undamaged?

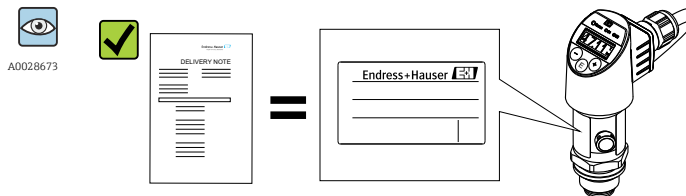

A0022104

Do the data on the nameplate correspond to the order specifications and the delivery note?

i If one of these conditions does not apply, please contact your Endress+Hauser sales office.

4.2 Product identification

The measuring device can be identified in the following ways:

- Nameplate specifications
- Order code with breakdown of the device features on the delivery note
- Enter serial number from nameplates in *W@M Device Viewer* (www.endress.com/deviceviewer): all the information about the measuring device is displayed.

For an overview of the technical documentation provided, enter the serial number from the nameplates in *W@M Device Viewer* (www.endress.com/deviceviewer)

4.2.1 Manufacturer address

Endress+Hauser SE+Co. KG
Hauptstraße 1
79689 Maulburg, Germany
Place of manufacture: See nameplate.

4.2.2 Nameplate

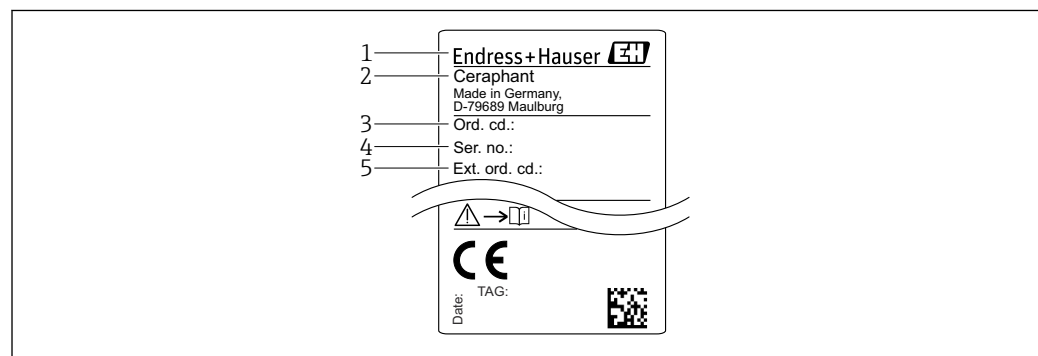

- 1 *Manufacturer address*
- 2 *Device name*
- 3 *Order number*
- 4 *Serial number*
- 5 *Extended order number*

4.3 Storage and transport

4.3.1 Storage conditions

Use original packaging.

Store the measuring device in clean and dry conditions and protect from damage caused by shocks (EN 837-2).

Storage temperature range

-40 to +85 °C (-40 to +185 °F)

4.3.2 Transporting the product to the measuring point

⚠ WARNING

Incorrect transport!

Housing and diaphragm may become damaged, and there is a risk of injury!

- ▶ Transport the measuring device to the measuring point in its original packaging or by the process connection.

5 Mounting

5.1 Installation conditions

- Moisture must not penetrate the housing when mounting the device, establishing the electrical connection and during operation.
- Do not clean or touch process isolating diaphragms with hard and/or pointed objects.
- Do not remove process isolating diaphragm protection until shortly before installation.
- Always tighten the cable entry firmly.
- Point the cable and connector downwards where possible to prevent moisture from entering (e.g. rain or condensation water).
- Protect housing against impact.
- For devices with gauge pressure sensor, the following applies:

NOTICE

If a heated device is cooled in the course of a cleaning process (by cold water, for example), a vacuum develops for a short time causing moisture to penetrate the sensor via the pressure compensation element (1).

Device could be destroyed!

- In the event of this happening, mount the device in such a way that the pressure compensation element (1) is pointing downwards at an angle or to the side, if possible.

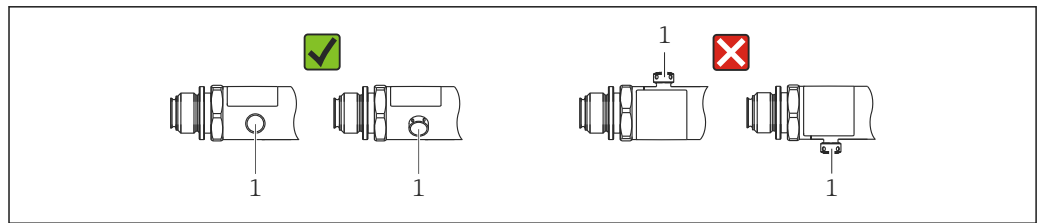

A0022252

5.2 Influence of orientation

Any orientation is possible. However, the orientation may cause a zero point shift, i.e. the measured value does not show zero when the vessel is empty or partially full.

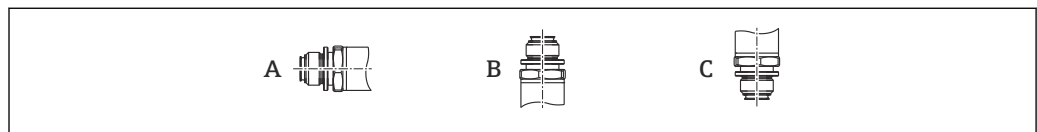

A0024708

PTP31B PTP33B

Process membrane axis is horizontal (A)	Process membrane pointing upwards (B)	Process membrane pointing downwards (C)
Calibration position, no effect	Up to +4 mbar (+0.058 psi)	Up to -4 mbar (-0.058 psi)

PTC31B

Type	Process membrane axis is horizontal (A)	Process membrane pointing upwards (B)	Process membrane pointing downwards (C)
< 1 bar (15 psi)	Calibration position, no effect	Up to +0.3 mbar (+0.0044 psi)	Up to -0.3 mbar (-0.0044 psi)
≥ 1 bar (15 psi)	Calibration position, no effect	Up to +3 mbar (+0.0435 psi)	Up to -3 mbar (-0.0435 psi)

 A position-dependent zero point shift can be corrected on the device.

5.3 Mounting location

5.3.1 Pressure measurement

Pressure measurement in gases

Mount the device with shutoff device above the tapping point so that any condensate can flow into the process.

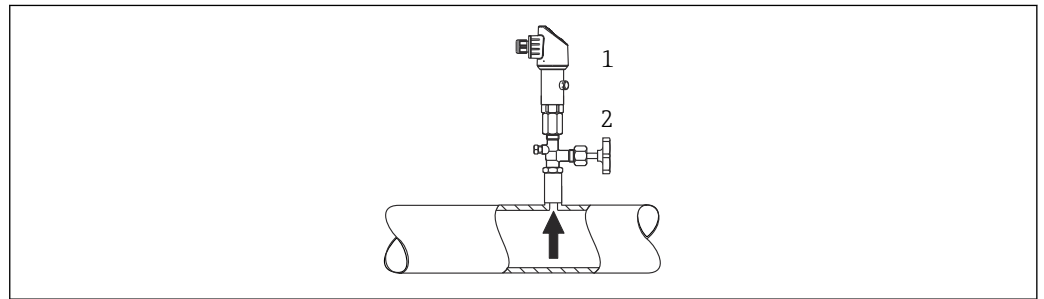

A0025920

- 1 Device
- 2 Shutoff device

Pressure measurement in vapors

For pressure measurement in vapors, use a siphon. The siphon reduces the temperature to almost ambient temperature. Preferably mount the device with the shutoff device and siphon below the tapping point.

Advantage:

- defined water column causes only minor/negligible measuring errors and
- only minor/negligible heat effects on the device.

Mounting above the tapping point is also permitted.

Note the max. permitted ambient temperature of the transmitter!

Take the influence of the hydrostatic water column into consideration.

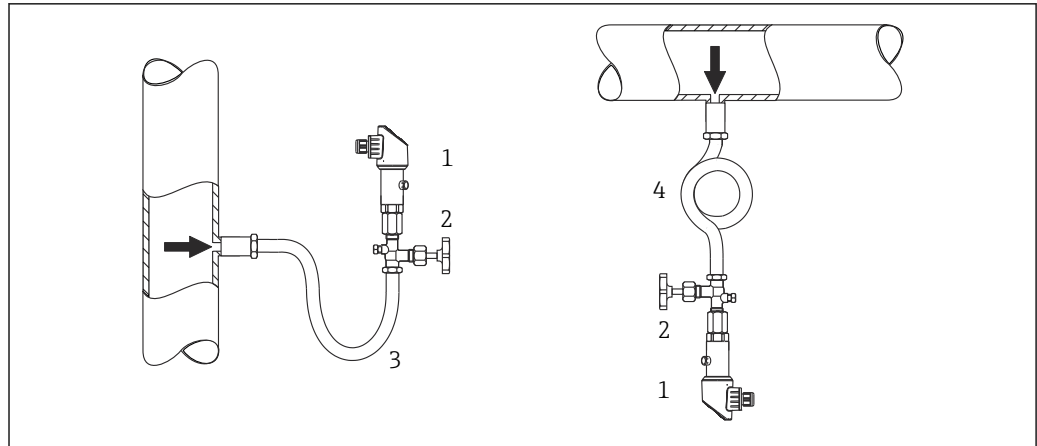

A0025921

- 1 Device
- 2 Shutoff device
- 3 Siphon
- 4 Siphon

Pressure measurement in liquids

Mount the device with a shutoff device and siphon below or at the same height as the tapping point.

Advantage:

- defined water column causes only minor/negligible measuring errors and
- air bubbles can be released to the process.

Take the influence of the hydrostatic water column into consideration.

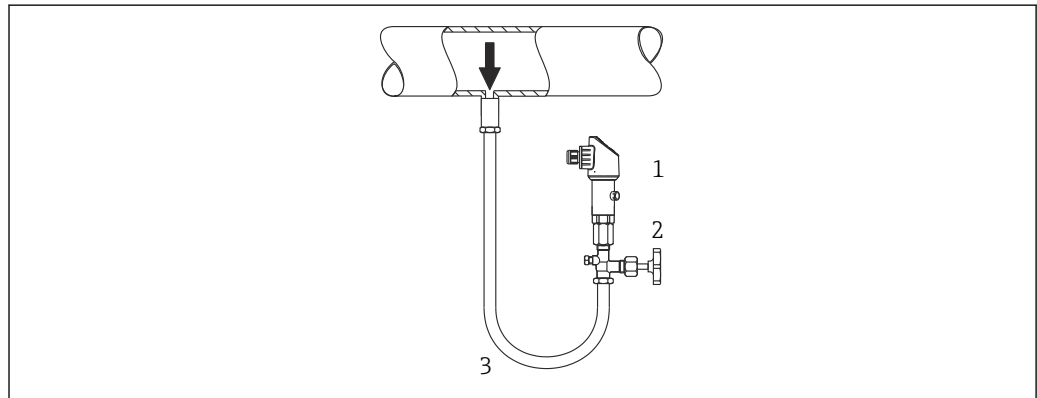

A0025922

- 1 Device
- 2 Shutoff device
- 3 Siphon

5.3.2 Level measurement

- Always install the device below the lowest measuring point.
- Do not install the device at the following positions:
 - in the filling curtain
 - in the tank outlet
 - in the suction area of a pump
 - at a point in the tank which could be affected by pressure pulses from the agitator.
- A functional test can be carried out more easily if you mount the device downstream from a shutoff device.

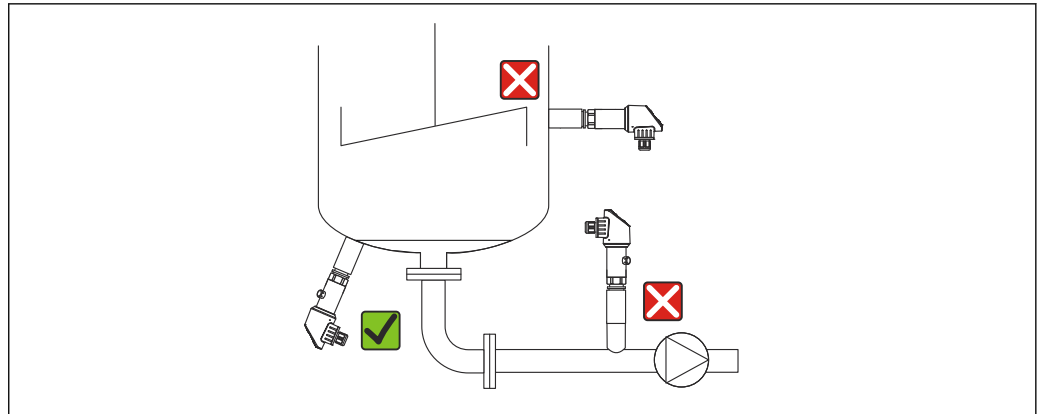

A0025923

5.4 Mounting instructions for oxygen applications

Oxygen and other gases can react explosively to oils, grease and plastics, such that, among other things, the following precautions must be taken:

- All components of the system, such as measuring devices, must be cleaned in accordance with the BAM requirements.
- Depending on the materials used, a certain maximum temperature and a maximum pressure must not be exceeded for oxygen applications.
- The following table lists devices (devices only, not accessories or enclosed accessories), which are suitable for gaseous oxygen applications.

PTC31B

p_{\max} for oxygen applications	T_{\max} for oxygen applications	Option ¹⁾
40 bar (600 psi)	-10 to +60 °C (+14 to +140 °F)	HB

1) Product Configurator, order code for "Service"

5.5 Post-mounting check

- Is the device undamaged (visual inspection)?
- Does the device comply with the measuring point specifications?
 - Process temperature
 - Process pressure
 - Ambient temperature
 - Measuring range
- Are the measuring point identification and labeling correct (visual inspection)?
- Is the device adequately protected against precipitation and direct sunlight?
- Are the securing screws firmly tightened?
- Is the pressure compensation element pointing downwards at an angle or to the side?
- To prevent the penetration of moisture: are the connecting cables/plugs pointing downwards?

6 Electrical connection

6.1 Connecting the measuring unit

6.1.1 Terminal assignment

⚠ WARNING

Risk of injury from the uncontrolled activation of processes!

- ▶ Switch off the supply voltage before connecting the device.
- ▶ Make sure that downstream processes are not started unintentionally.

⚠ WARNING

Electrical safety is compromised by an incorrect connection!

- ▶ In accordance with IEC/EN61010 a separate circuit breaker must be provided for the device.
- ▶ The device must be operated with a 630 mA fine-wire fuse (slow-blow).
- ▶ The maximum current is restricted to $I_i = 100 \text{ mA}$ by the transmitter power supply unit when the device is used in an intrinsically safe circuit (Ex ia).
- ▶ Protective circuits against reverse polarity are integrated.

NOTICE

Damage to analog input of PLC resulting from incorrect connection

- ▶ Do not connect the active PNP switch output of the device to the 4 to 20 mA input of a PLC.

Connect the device in the following order:

1. Check that the supply voltage corresponds to the supply voltage indicated on the nameplate.
2. Connect the device in accordance with the following diagram.

Switch on supply voltage.

1 x PNP switch output R1 (not with IO-Link functionality)

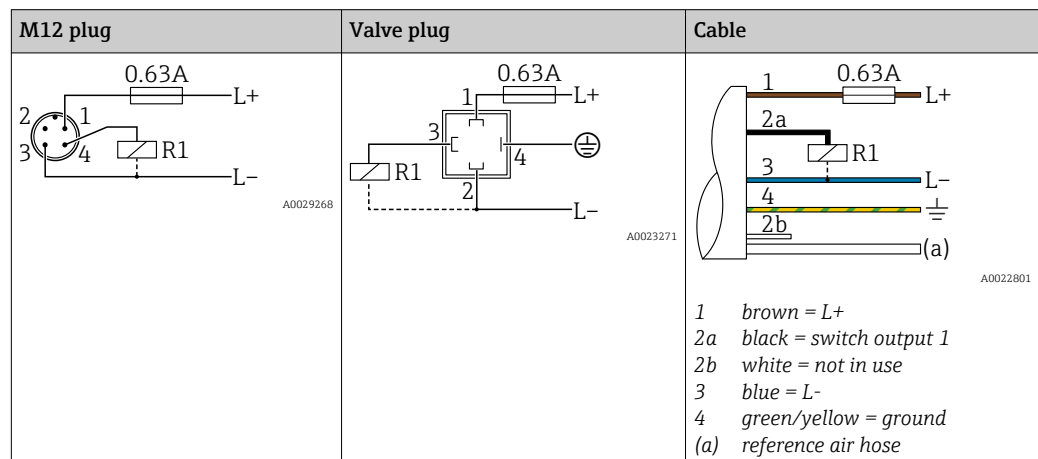

2 x PNP switch output R1 and R2 (not with IO-Link functionality)

M12 plug	Valve plug	Cable
<p>A0023248</p>	-	<p>A0023282</p> <p>1 brown = L+ 2a black = switch output 1 2b white = switch output 2 3 blue = L- 4 green/yellow = ground (a) reference air hose</p>

IO-Link: 2 x PNP switch output R1 and R2

M12 plug
<p>A0036997</p>

1 x PNP switch output R1 with additional analog output 4 to 20 mA (active), (not with IO-Link functionality)

M12 plug	Valve plug	Cable
<p>A0023249</p>	-	<p>A0030519</p> <p>1 brown = L+ 2a black = switch output 1 2b white = analog output 4 to 20 mA 3 blue = L- 4 green/yellow = ground (a) reference air hose</p>

IO-Link: 1 x PNP switch output R1 with additional analog output 4 to 20 mA (active)

M12 plug
<p>A0036998</p>

6.1.2 Supply voltage

Supply voltage IO-Link: 10 to 30 V DC at a DC power unit

IO-Link communication is guaranteed only if the supply voltage is at least 18 V.

6.1.3 Current consumption and alarm signal

Intrinsic power consumption	Alarm current (for devices with analog output) ¹⁾
≤ 60 mA	≥ 21 mA (factory setting)

1) Setting min. alarm current ≤ 3.6 mA can be ordered via the product order structure. Min. alarm current ≤ 3.6 mA can be configured at the device or via IO-Link.

6.2 Connection data

6.2.1 Relay switching capacity

- Switch state ON ¹⁾: $I_a \leq 200 \text{ mA}$ ²⁾; Switch state OFF: $I_a \leq 100 \mu\text{A}$
- Switch cycles: > 10,000,000
- Voltage drop PNP: ≤ 2 V
- Overload protection: Automatic load testing of switching current;
 - Max. capacitance load: 1 μF at max. supply voltage (without resistive load)
 - Max. cycle duration: 0.5 s; min. t_{on} : 40 μs
 - Periodic disconnection from protective circuit in the event of overcurrent ($f = 2 \text{ Hz}$) and "F804" displayed

6.2.2 Load (for devices with analog output)

In order to guarantee sufficient terminal voltage, a maximum load resistance R_L (including line resistance) must not be exceeded depending on the supply voltage U_B of the supply unit.

The maximum load resistance depends on the terminal voltage and is calculated according to the following formula:

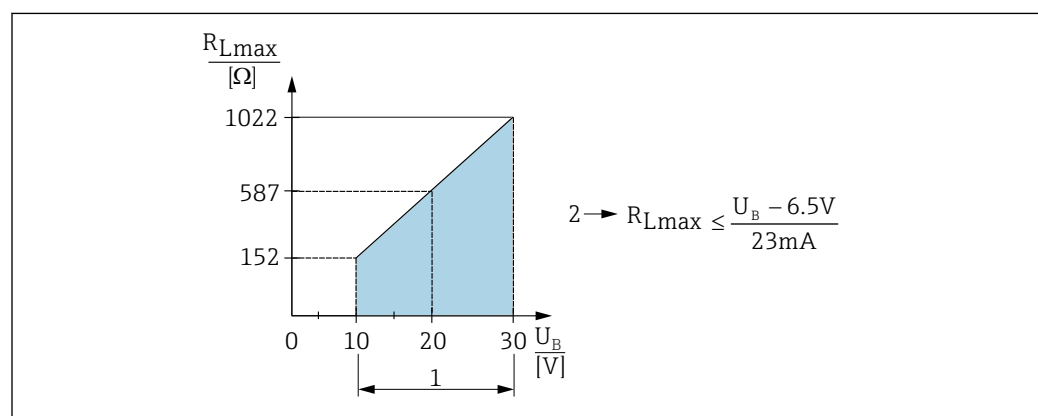

- 1 Power supply 10 to 30 V DC
 2 $R_{L\text{max}}$ maximum load resistance
 U_B Supply voltage

- 1) For switch outputs "2 x PNP" and "1 x PNP + 4 to 20 mA output", 100 mA can be guaranteed over the entire temperature range. For lower ambient temperatures, higher currents are possible but cannot be guaranteed. Typical value at 20 °C (68 °F) approx. 200 mA. For switch output "1 x PNP", 200 mA can be guaranteed over the entire temperature range.
- 2) Deviating from the IO-Link standard, larger currents are supported.

If load is too great:

- failure current is output and "S803" displayed (output: MIN alarm current)
- Periodic checking to establish if it is possible to quit fault state
- In order to guarantee sufficient terminal voltage, a maximum load resistance RL (including line resistance) must not be exceeded depending on the supply voltage UB of the supply unit.

6.3 Post-connection check

<input type="checkbox"/>	Are the device and cables undamaged (visual check)?
<input type="checkbox"/>	Do the cables used comply with the requirements?
<input type="checkbox"/>	Are the mounted cables relieved of tension?
<input type="checkbox"/>	Are all cable glands installed, securely tightened and leak-tight?
<input type="checkbox"/>	Does the supply voltage match the specifications on the nameplate?
<input type="checkbox"/>	Is the terminal assignment correct?
<input type="checkbox"/>	If required: has protective ground connection been established?
<input type="checkbox"/>	If supply voltage is present: is the device ready for operation and do values appear on the display module or is the green status LED lit?

7 Operation options

7.1 Operation with operating menu

7.1.1 IO-Link

IO-Link information

IO-Link is a point-to-point connection for communication between the measuring device and an IO-Link master. The measuring device features an IO-Link communication interface type 2 with a second IO function on pin 4. This requires an IO-Link-compatible assembly (IO-Link master) for operation. The IO-Link communication interface enables direct access to the process and diagnostic data. It also provides the option of configuring the measuring device while in operation.

Physical layer, the measuring device supports the following features:

- IO-Link specification: Version 1.1
- IO-Link Smart Sensor Profile 2nd Edition
- SIO mode: Yes
- Speed: COM2; 38.4 kBaud
- Minimum cycle time: 2.5 msec.
- Process data width:
 - Without Smart Sensor Profile: 32 bit
 - With Smart Sensor Profile: 48 bit (float32 + 14-bit vendor spec. + 2 bits SSC)
- IO-Link data storage: Yes
- Block configuration: Yes

IO-Link download

<http://www.endress.com/download>

- Select "Software" as the media type.
- Select "Device Driver" as the software type.
Select IO-Link (IODD).
- In the "Text Search" field enter the device name.

<https://ioddfinder.io-link.com/>

Search by

- Manufacturer
- Article number
- Product type

7.1.2 Operation concept

Operation with an operating menu is based on an operation concept with "user roles".

User role	Meaning
Operator (display level)	Operators are responsible for the devices during normal "operation". This is usually limited to reading process values either directly at the device or in a control room. If an error occurs, these users simply forward the information on the errors but do not intervene themselves.
Maintenance (user level)	Service engineers usually work with the devices in the phases following device commissioning. They are primarily involved in maintenance and troubleshooting activities for which simple settings have to be made on the device. Technicians work with the devices over the entire life cycle of the product. Thus, commissioning and advanced settings and configurations are some of the tasks they have to carry out.

7.1.3 Structure of the operating menu

The menu structure has been implemented according to VDMA 24574-1 and complemented by Endress+Hauser-specific menu items.

User role	Submenu	Meaning/use
Operator (display level)	Display/operat.	Display of measured values, fault and information messages
Maintenance (user level)	Parameters on the topmost menu level.	Contains all the parameters that are needed to commission measuring operations. A wide range of parameters, which can be used to configure a typical application, is available at the start. After making settings for all these parameters, the measuring operation should be completely configured in the majority of cases.
	EF	The "EF" submenu (Extended Functions) contains additional parameters which allow more accurate configuration of the measurement, conversion of the measured value and scaling of the output signal.
	DIAG	Contains all the parameters that are needed to detect and analyze operating errors.

 For an overview of the operating menu, see →  55 and →  60

7.2 Operation with local display

7.2.1 Overview

A 1-line liquid crystal display (LCD) is used for display and operation. The local display shows measured values, fault messages and information messages and therefore supports the user through each operating step.

The display is fixed to the housing and can be electronically rotated 180° (see parameter description for "DRO" →  82). This ensures optimum readability of the local display and allows the device to be mounted upside down also.

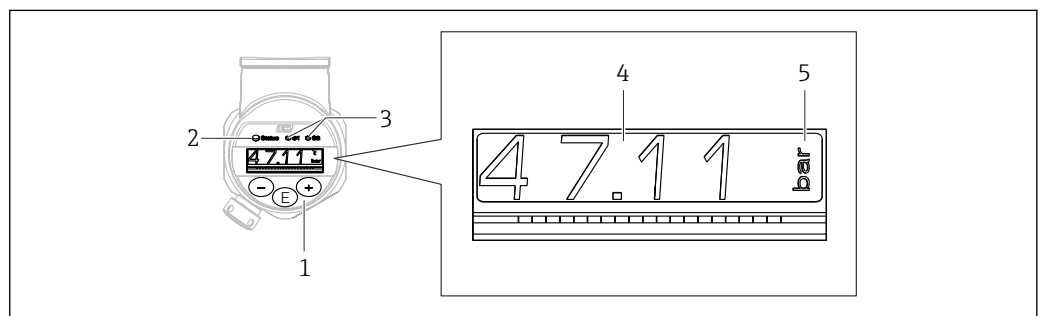

During measuring operation, the display shows measured values, fault messages and notice messages. In addition, it is possible to switch to menu mode via the operating keys.



- 1 Operating keys
- 2 Status LED
- 3 Switch output LEDs
- 4 Measured value
- 5 Unit





The second switch output is not used for the device version with current output.

7.2.2 Information on the operational states

Operational states	Function of status-LED and onsite display
Operation	<ul style="list-style-type: none"> Status LED is lit green LEDs of switch output 1 and switch output 2 signal the status of each switch output No activity of LED for switch output 2 if current output is active White background lighting
Problem	<ul style="list-style-type: none"> Status LED lit steady red Red display background LED of switch output 1 and switch output 2 off (switch output is deactivated)
Warning	<ul style="list-style-type: none"> Status LED flashing red White display background LEDs of switch output 1 and switch output 2 signal the status of each switch output
For Device Search	<ul style="list-style-type: none"> The green LED is lit (= operational) on the device and starts to flash with increased luminosity. Flash frequency  LEDs of switch output 1 and switch output 2 signal the status of each switch output Display background depending on the device status
IO-Link communication	<ul style="list-style-type: none"> Status LED flashes green as per IO-Link specification (regardless of measuring operation, error or warning). Flash frequency  Display background depending on the device status The state of switch output 1 is also indicated via the LED of switch output 1 at the same time as the process data are displayed

7.3 General value adjustment and rejection of illegal entries



Parameter (not numerical value) is flashing: parameter can be adjusted or selected.



When adjusting a numerical value: the numerical value does not flash. The first digit of the numerical value starts to flash only when the  key is pressed by way of confirmation. Enter the desired value with the  or  key and press the  key to confirm. Following confirmation, the data are recorded directly and are active.

- Entry is OK: value is accepted and shown for one second on the display against a white background.
- Entry is not OK: the message "FAIL" appears for one second on the display against a red background. The value entered is rejected. In the event of an incorrect setting which affects the TD, a diagnostic message is displayed.

7.4 Navigation and selection from list

The capacitive operating keys are used for navigation in the operating menu and to select an option from a picklist.

Operating key(s)	Meaning
 <small>A0017879</small>	<ul style="list-style-type: none"> Navigate downwards in the picklist Edit the numerical values and characters within a function
 <small>A0017880</small>	<ul style="list-style-type: none"> Navigate upwards in the picklist Edit the numerical values and characters within a function
 <small>A0017881</small>	<ul style="list-style-type: none"> Confirm entry Jump to the next item Selection of a menu item and activation of edit mode The key lock function (KYL) is accessed by pressing the key for longer than 2 seconds

Operating key(s)	Meaning
Simultaneously  and  <small>A0017879</small> <small>A0017880</small>	ESC functions: <ul style="list-style-type: none">▪ Exit the edit mode for a parameter without saving the changed value▪ You are in the menu at a selection level: each time you press the keys simultaneously, you go up a level in the menu.▪ Long ESC: press the keys for longer than 2 seconds

7.5 Locking and unlocking operation

The device features

- Automatic key locking
- Parameter settings lock.





Key locking is indicated on the local display by "E > 2".



Locking of the parameter settings is indicated as soon as an attempt is made to change a parameter.

7.5.1 Disabling the key lock

The keys are locked automatically if the device remains at the topmost menu level (display of pressure measurement value) for 60 seconds.

Call up the key lock function (KYL)

1. Press the  key for at least 2 seconds and then release it
2. By confirming with  "ON" is displayed
3. Use  and  to toggle between "ON" and "OFF"
4. Key locking is disabled as soon as  is pressed to confirm "OFF"

The display changes to the main value level (topmost menu level) if the  key is pressed briefly. The display changes to the key locking if the  key is pressed for at least 2 seconds.

If in the case of "KYL", "ON" or "OFF", more than 10 seconds elapse without a key being pressed, you return to the topmost menu level with active key locking.

The function can be accessed anytime outside the main measured value display and within the operating menu, i.e. if the  key is pressed for at least 2 seconds key locking can be performed anytime at any menu item. Locking is effective immediately. If you quit the context menu, you will return to the same point from which key locking was selected.

7.5.2 Locking and unlocking parameter settings

The device settings can be protected from unauthorized access.

COD parameter: define the locking code

0000	Device is permanently unlocked (factory setting)
0001-9999	Device is locked

LCK parameter: unlock parameter locking (enter the COD)

If parameters are locked, the word "LCK" appears on the local display as soon as an attempt is made to change a parameter.

Examples:

Locking the device with a customer-specific code

1. EF → ADM → COD
2. Enter a COD not equal to 0000 (value range: 0001 to 9999)
3. Wait 60 seconds or restart the device
4. Parameters are locked (protected against changes)

Changing a parameter when the device is locked (taking the example of STL)

1. STL, LCK is displayed

2. Enter the customer-specific value defined in COD
3. STL can be edited
4. The device is locked again after 60 seconds or following a restart

Unlocking the locking mechanism permanently

1. EF → ADM → COD
2. LCK is displayed, enter the customer-specific value defined in COD
3. Enter "0000"
4. The device is unlocked (even after the device is restarted)

7.6 Navigation examples

7.6.1 Parameters with a picklist

Example: Display measured value rotated by 180°

Menu path: EF → DIS → DRO

Press $\left[\right]$ or $\left[\right]$ key until "DRO" is displayed.	<input type="text" value="D R O"/>
The default setting is "NO" (display is not rotated).	<input type="text" value="N O"/>
Press $\left[\right]$ or $\left[\right]$ until "YES" appears (display is rotated by 180°).	<input type="text" value="Y E S"/>
Press $\left[\right]$ to confirm the setting.	<input type="text" value="D R O"/>

7.6.2 User-definable parameters

Example: setting the "TAU" damping parameter.

Menu path: EF → TAU

Press $\left[\right]$ or $\left[\right]$ key until "TAU" is displayed.	<input type="text" value="T A U"/>
Press $\left[\right]$ to set the damping (min. = 0.0 s; max.= 999.9 s).	<input type="text" value="0. 3 0"/>
Press $\left[\right]$ or $\left[\right]$ to go up or down. Press $\left[\right]$ to confirm the entry and to go to the next position.	<input type="text" value="1. 5"/>
Press $\left[\right]$ to quit the setting function and to go to the "TAU" menu item.	<input type="text" value="T A U"/>

7.7 Status LEDs

The Ceraphant also uses LEDs to signal the status:

- Two LEDs indicate the status of the switch outputs (switch output 2 can optionally be used as a current output)
- One LED indicates if the device is switched on or if an error or fault has occurred

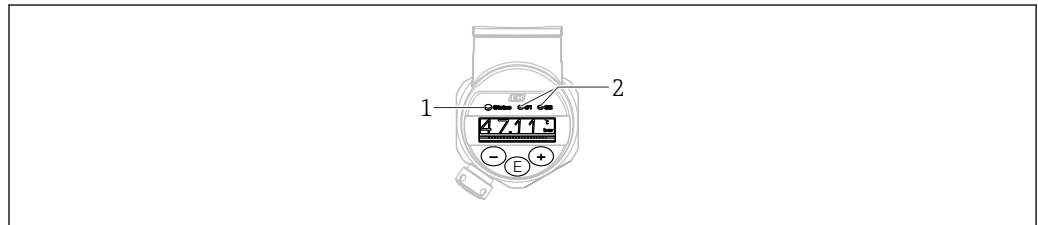

- 1 Status LED
2 Switch output LEDs

A0032027

7.8 Resetting to factory settings (reset)

See the "Standard Command (Restore factory settings)" parameter description

8 System integration

8.1 Process data

The measuring device has one current output and one or two switch outputs (depending on the version ordered). The status of the switch outputs and the pressure value are transmitted in the form of process data via IO-Link.

- In the SIO mode, the switch output is switched at pin 4 of the M12 plug. In the IO-Link communication mode, this pin is reserved exclusively for communication.
- If the "with current output" option is ordered, the current output at pin 2 of the M12 plug is always active or can optionally be deactivated via IO-Link or at the display or configured as DC-PMP.

8.1.1 Without Smart Sensor Profile

The device's process data are transmitted cyclically in 32-bit chunks.

Bit	0 (LSB)	1	...	28	29 (MSB)	30	31
Measuring device	Pressure value					OU1	res.

Bit 31 is reserved. Bit 30 provides the status of the switch output.

Here, 1 or DC 24 V corresponds to the logical "closed" state on the switch output. The remaining 30 bits contain the analog raw measured value of the device. This value has yet to be scaled by the target system to the nominal operating range of the existing measuring device.

Bit	Process value	Value range
30	OU1	0 = open 1 = closed
0 - 29	Raw value	Integer

The pressure value is provided by the measuring device as int30. The decimal separator must be set with a gradient. The number of decimal places displayed is based on the display format of the device. The gradients depend on the unit in question. The following units are available:

- bar: 0.0001
- kPa: 0.01
- MPa: 0.00001
- psi: 0.001

Examples:

Pressure value	Transmitted	Scaled with gradient
-320 mbar	-3200	-0.32
22 bar	220000	22
133 kPa	13300	133
665 psi	665000	665
399.5 bar	3995000	399.5

8.1.2 With Smart Sensor Profile

The measuring device's process data are transmitted cyclically as per SSP 4.3.1.

Bit offset	Name	Data type	Permitted values	Offset/gradient	Description
0	Process Data Input.Switching Signal Channel 1.1 Pressure	1-bit Uinteger	0 = False 1 = True	-	Switching signal status SSC 1.1
1	Process Data Input.Switching Signal Channel 1.2 Pressure	1-bit Uinteger	0 = False 1 = True	-	Switching signal status SSC 1.2
8	Summary status (Condensed)	8-bit Uinteger	<ul style="list-style-type: none"> ▪ 36 = Error ▪ 60 = Function check ▪ 120 = Outside specifications ▪ 128 = Good ▪ 129 = Simulation ▪ 164 = Maintenance required 	-	Summary status as per PI specification
16	Pressure	Float32	-	psi: 0 / 0.0001450326 bar: 0 / 0.00001 kPa: 0 / 0.001 MPa: 0 / 0.000001	Current pressure

Process Value Pressure [Float32] [47...16 bit]		
Condensed status [15...8 bit]	N/A [7...2 bit]	SSC 1.1-1.2 [1.0 bit]

8.2 Reading out and writing device data (ISDU – Indexed Service Data Unit)

Device data are always exchanged acyclically and at the request of the IO-Link master. Using the device data, the following parameter values or device statuses can be read out:

8.2.1 Endress+Hauser-specific device data

ISDU (dec)	Name	ISDU (hex)	Size (byte)	Data type	Access	Default value	Value range	Offset/gradient	Data storage
66	Simulation Current Output (OU2)	0x0042	1	uint	r/w	off	4 ~ 4 mA, 5 ~ 8 mA, 6 ~ 12 mA, 7 ~ 16 mA, 8 ~ 20 mA, 9 ~ 21.95 mA, otherwise 3.5 mA		No
67	Unit changeover (UNI)	0x0043	1	uint	r/w		0 ~ bar, 1 ~ kPa, 2 ~ psi, 3 ~ MPa		Yes
68	Zero point configuration (ZRO)	0x0044	4	int	r/w	0	in 00.00%, default 0.00%		Yes
69	Zero point adoption (GTZ)	0x0045	1	uint	-/w				No
70	Damping (TAU)	0x0046	2	uint	r/w	20	in 000.0 sec, default 2.0 sec	0 / 0.1	Yes

ISDU (dec)	Name	ISDU (hex)	Size (byte)	Data type	Access	Default value	Value range	Offset/gradient	Data storage
71	Lower Range Value for 4 mA (STL)	0x0047	4	int	r/w	0	in 00.00%, default 0.00%	bar: 0 / 0.001 kPa: 0 / 0.1 MPa: 0 / 0.0001 psi: 0 / 0.01	Yes
72	Upper Range Value for 20 mA (STU)	0x0048	4	int	r/w	10000	in 00.00%, default 100.00%	bar: 0 / 0.001 kPa: 0 / 0.1 MPa: 0 / 0.0001 psi: 0 / 0.01	Yes
73	Pressure applied for 4mA (GTL)	0x0049	1	uint	-/w				No
74	Pressure applied for 20mA (GTU)	0x004A	1	uint	-/w				No
75	Alarm current (FCU)	0x004B	1	uint	r/w	MAX	0 ~ MIN, 1 ~ MAX, 2 ~ HOLD		Yes
82	Hi Max value (maximum indicator)	0x0052	4	int	r/-				No
83	Lo Min value (minimum indicator)	0x0053	4	int	r/-				No
84	Revisioncounter (RVC)	0x0054	2	uint	r/-				No
85	Simulation Switch Output (OU1)	0x0055			r/w	off	0 ~ off, 1 ~ low, 2 ~ high,		
86	Simulation Switch Output (OU2)	0x0056	1	uint	r/w	off	0 ~ off, 1 ~ low, 2 ~ high		No
87	Device search	0x0057	1	uint	r/w	off	0 ~ off 1 ~ on		No
88	Operating Mode (FUNC)	0x0058	1	uint	r/w	1	0 ~ off, 1 ~ I, 2 ~ PNP		Yes
94	Unlocking code (LCK)	0x005E	2	uint	-/w	0			Yes
95	Locking code (COD)	0x005F	2	uint	-/w	0			Yes
96	Measured value display (DVA)	0x0060	1	uint	r/w	0	0~ PV for device with non-active current output 1~ PV% only for devices with active current output 2~display set switch point SP		Yes
97	Display measured value rotated by 180° (DRO)	0x0061	1	uint	r/w	NO	0 ~ NO, 1 ~ YES		Yes
98	Switch display on or off (DOF)	0x0062	1	uint	r/w	NO	0 ~ NO, 1 ~ YES		Yes
256	Device Type	0x0100	2	UInteger16	r/-	0x92FE			
257	ENP_VERSION	0x0101	16	String	r/-	36587			
259	Extended order code	0x0103	60	String	r/-				

Without Smart Sensor Profile

ISDU (dec)	Name	ISDU (hex)	Size (byte)	Data type	Access	Default value	Value range	Offset/gradient	Data storage
77	Switch point value/Upper value for pressure window, output 1 (SP1/FH1)	0x004D	4	int	r/w	9000	in 00.00%, default 90.00%	bar: 0 / 0.001 kPa: 0 / 0.1 MPa: 0 / 0.0001 psi: 0 / 0.01	Yes
78	Switchback point value/Lower value for pressure window, output 1 (rP1/FL1)	0x004E	4	int	r/w	1000	in 00.00%, default 10.00%	bar: 0 / 0.001 kPa: 0 / 0.1 MPa: 0 / 0.0001 psi: 0 / 0.01	Yes
79	Switching delay time, output 1 (dS1)	0x004F	2	uint	r/w	0	in 00.00 sec	0 / 0.01	Yes
80	Switchback delay time, output 1 (dR1)	0x0050	2	uint	r/w	0	in 00.00 sec	0 / 0.01	Yes
81	Output 1 (OU1)	0x0051	1	uint	r/w	HNO	0 ~ HNO ¹⁾ , 1 ~ HNC ¹⁾ , 2 ~ FNO ¹⁾ , 3 ~ FNC ¹⁾		Yes
89	Switch point value / Upper value for pressure window, output 2 (SP2 / FH2)	0x0059	4	int	r/w	9500	in 00.00%, default 95.00%	bar: 0 / 0.001 kPa: 0 / 0.1 MPa: 0 / 0.0001 psi: 0 / 0.01	Yes
90	Switchback point value / Lower value for pressure window, output 2 (rP2 / FL2)	0x005A	4	int	r/w	1500	in 00.00%, default 15.00%	bar: 0 / 0.001 kPa: 0 / 0.1 MPa: 0 / 0.0001 psi: 0 / 0.01	Yes
91	Switching delay time, output 2 (dS2)	0x005B	2	uint	r/w	0	in 00.00 sec	0 / 0.01	Yes
92	Switchback delay time, output 2 (dR2)	0x005C	2	uint	r/w	0	in 00.00 sec	0 / 0.01	Yes
93	Output 2 (OU2)	0x005D	1	uint	r/w	HNC	0 ~ HNO ¹⁾ , 1 ~ HNC ¹⁾ , 2 ~ FNO ¹⁾ , 3 ~ FNC ¹⁾		Yes

1) Refer to the parameter description for an explanation on abbreviations

8.2.2 IO-Link-specific device data

ISDU (dec)	Name	ISDU (hex)	Size (byte)	Data type	Access	Default value
7 ... 8	VendorId	0x0007 to 0x0008			r/-	17
9 ... 11	DeviceId	0x0009 to 0x000B			r/-	0x0007xx
16	VendorName	0x0010	max. 64	String	r/-	Endress+Hauser
17	VendorText	0x0011	max. 64	String	r/-	People for Process Automation
18	ProductName	0x0012	max. 64	String	r/-	Ceraphant
19	ProductID	0x0013	max. 64	String	r/-	PTx3xB
20	ProductText	0x0014	max. 64	String	r/-	Absolute and gauge pressure
21	Serial number	0x0015	max. 16	String	r/-	
22	Hardware Version	0x0016	max. 64	String	r/-	
23	Firmware version	0x0017	max. 64	String	r/-	
24	Application Specific Tag	0x0018	32	String	r/w	

ISDU (dec)	Name	ISDU (hex)	Size (byte)	Data type	Access	Default value
260	Actual Diagnostics (STA)	0x0104	4	String	r/-	
261	Last Diagnostic (LST)	0x0105	4	String	r/-	

With Smart Sensor Profile

ISDU (dec)	Name	ISDU (hex)	Size (byte)	Data type	Access	Default value	Value range	Data storage
25	Function Tag	0x0019	10	StringT	r/w	***	-	Yes
26	Location Tag	0x001A	10	StringT	r/w	***	-	Yes
36	Device Status	0x0024	1	Integer T	r	0	0 ~ Device is OK 1 ~ Maintenance required 2 ~ Out of specification 3 ~ Functional check 4 ~ Failure	No
37	Detailed Device Status	0x0025	3	OctetStringT		-	-	No

Teach - Single value

ISDU (dec)	Name	ISDU (hex)	Size (byte)	Data type	Access	Default value	Value range	Data storage
58	Teach Select	0x003A	1	UIntegerT	r/w	1	0 ~ Default Channel = SSC1.1 Pressure 1 ~ SSC1.1 Pressure 2 ~ SSC1.2 success 255 ~ All SSC	No
59	Teach Result State	0x003B	1	UIntegerT	r	0	0 ~ Idle 1 ~ SP1 success 2 ~ SP2 success 3 ~ SP1, SP2 success 4 ~ Wait for command 5 ~ Busy 7 ~ Error	No

Switching Signal Channel 1.1 Pressure

ISDU (dec)	Subindex	Name	ISDU (hex)	Size (byte)	Data type	Access	Default value	Value range	Data storage
60	24	SSC1.1 Param.SP1	0x003C	4	Float32T	r/w	9000.0	-	Yes
60	23	SSC1.1 Param.SP2	0x003C	4	Float32T	r/w	1000.0	-	Yes
61	01	SSC1.1 Config.Logic	0x003D	1	UIntegerT	r/w	0	0 ~ High active 1 ~ Low active	Yes
61	02	SSC1.1 Config.Mode	0x003D	1	UIntegerT	r/w	0	0 ~ Deactivation 1 ~ Single point 2 ~ Window 3 ~ Two-point	Yes
61	03	SSC1.1 Config.Hyst	0x003D	4	Float32T	r/w	10.0	-	Yes

Switching Signal Channel 1.2 Pressure

ISDU (dec)	Subindex	Name	ISDU (hex)	Size (byte)	Data type	Access	Default value	Value range	Data storage
60	24	SSC1.2 Param.SP1	0x003C	4	Float32T	r/w	9500.0	-	Yes
60	23	SSC1.2 Param.SP2	0x003C	4	Float32T	r/w	1500.0	-	Yes
61	01	SSC1.2 Config.Logic	0x003D	1	UIntegerT	r/w	0	0 ~ High active 1 ~ Low active	Yes
61	02	SSC1.2 Config.Mod e	0x003D	1	UIntegerT	r/w	0	0 ~ Deactivation 1 ~ Single point 2 ~ Window 3 ~ Two- point	Yes
61	03	SSC1.2 Config.Hyst	0x003D	4	Float32T	r/w	10.0	-	Yes

Measurement Data Information

ISDU (dec)	Subindex	Name	ISDU (hex)	Size (byte)	Data type	Access	Default value	Value range	Data storage
16512	1	MDC Descriptor - Pressure.Lo wer Value	0x4080	4	Float32T	r	0	-	No
16512	2	MDC Descriptor - Pressure.Up per Value	0x4080	4	Float32T	r	0	-	No
16512	3	MDC Descriptor - Pressure.Un it Code	0x4080	2	UIntegerT	r	1130 (Pa)	-	No
16512	4	MDC Descriptor - Pressure.Sca le	0x4080	1	IntegerT	r	0	-	No

8.2.3 System commands**Without Smart Sensor Profile**

ISDU (dec)	Subindex	Name	ISDU (hex)	Value range	Access
2	130	Reset to factory settings (RES)	0x0002	130	w
12	1	Device Access Locks.Data Storage Lock	0x000C	0 ~ False 2 ~ True	rw

With Smart Sensor Profile

ISDU (dec)	Subindex	Name	ISDU (hex)	Access
2	65	Teach SP1	0x0002	w
2	66	Teach SP2	0x0002	w
2	130	Reset to factory settings (RES)	0x0002	w
2	131	Back-To-Box	0x0002	w

8.2.4 Switching signals (with Smart Sensor Profile)

The switching signals offer a simple way of monitoring the measured values for limit violations.

Each switching signal is clearly assigned to a process value and provides a status. This status is transmitted with the process data (process data link). Its switching behavior must be configured using the configuration parameters of a "Switching Signal Channel" (SSC). In addition to manual configuration for switch points SP1 and SP2, a teach mechanism is available in the "Teach" menu. This mechanism writes the current process value to the selected SSC via a system command. The following section illustrates the different behaviors of the modes available for selection. The "Logic" parameter is always "High active" in these cases. If the logic is supposed to be inverted, the "Logic" parameter can be set to "Low active"().

Single Point Mode

SP2 is not used in this mode.

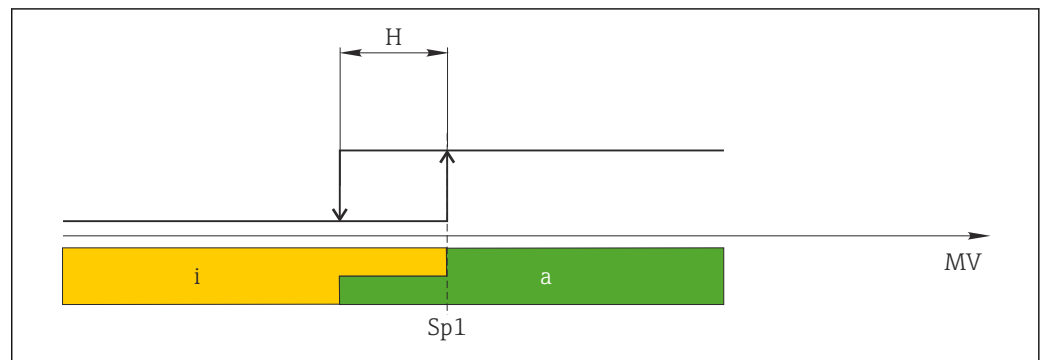

1 SSC, Single Point

- H* Hysteresis
- Sp1* Switch point 1
- MV* Measured value
- i* inactive (orange)
- a* active (green)

Window Mode

SP_{hi} always corresponds to whichever value is higher, SP1 or SP2, and SP_{lo} always corresponds to whichever value is lower, SP1 or SP2.

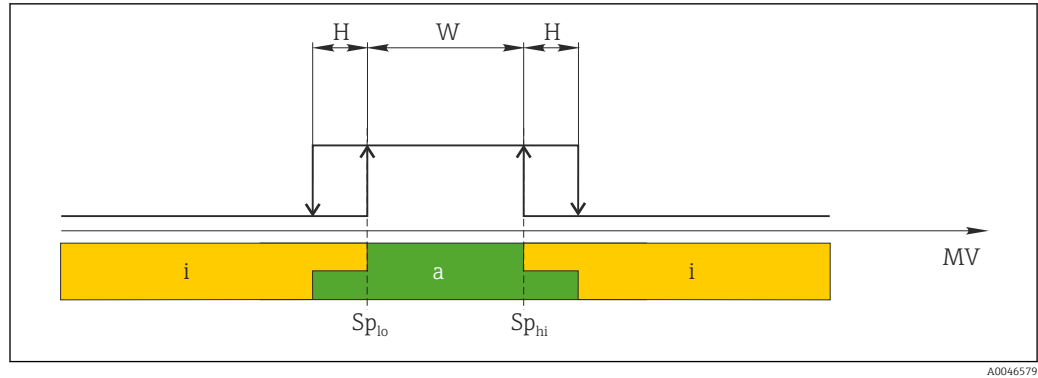

A0046579

2 SSC, Window

H Hysteresis

W Window

Sp_{lo} Switch point with lower measured value

Sp_{hi} Switch point with higher measured value

MV Measured value

i inactive (orange)

a active (green)

Two-point mode

Sp_{hi} always corresponds to whichever value is higher, $SP1$ or $SP2$ and Sp_{lo} always corresponds to whichever value is lower value, $SP1$ or $SP2$.

Hysteresis is not used.

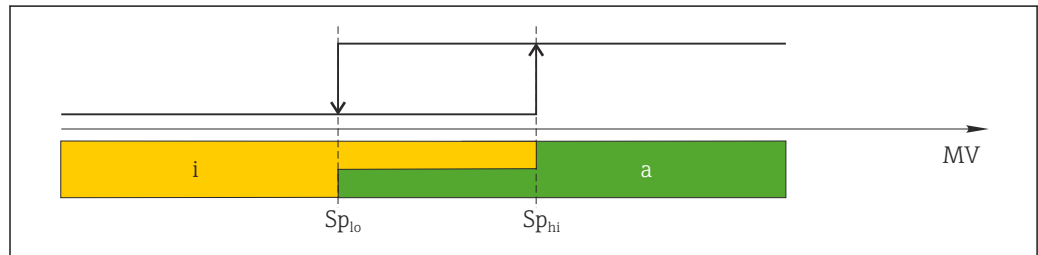

A0046578

3 SSC, Two-point

Sp_{lo} Switch point with lower measured value

Sp_{hi} Switch point with higher measured value

MV Measurement value

i Inactive (orange)

a Active (green)

9 Commissioning

If an existing configuration is changed, measuring operation continues! The new or modified entries are only accepted once the setting has been made.

If block parameter configuration is used, a parameter change is only adopted after the parameter download.

⚠ WARNING

Risk of injury from the uncontrolled activation of processes!

- ▶ Make sure that downstream processes are not started unintentionally.

⚠ WARNING

If a pressure smaller than the minimum permitted pressure or greater than the maximum permitted pressure is present at the device, the following messages are output in succession:

- ▶ S140
- ▶ F270

NOTICE

An IODD with corresponding default values is used for all pressure measuring ranges. This IODD applies to all measuring ranges! The default values of this IODD may not be valid for this device. IO-Link messages (e.g. "Parameter value above limit") may be displayed when the device is updated with these default values. Existing values are not accepted in this case. The default values apply exclusively to the 10 bar (150 psi) sensor.

- ▶ Before default values are written from the IODD to the device, the data must first be read from the device.



9.1 Function check

Before commissioning your measuring point, ensure that the post-installation and post-connection checks have been performed:

- Checklist for "Post-mounting check" →  19
- Checklist for "Post-connection check"

9.2 Commissioning with an operating menu

Commissioning comprises the following steps:

- Configure pressure measurement →  40
- Where necessary, perform position adjustment →  42
- Where necessary, configure process monitoring →  44

9.3 Configuring pressure measurement

9.3.1 Adjustment without reference pressure (dry adjustment = adjustment without medium)

Example:



In this example, a device with a 400 mbar (6 psi) sensor is configured for the measuring range 0 to 300 mbar (0 to 4.4 psi).



The following values should be assigned:

- 0 mbar = 4 mA value
- 300 mbar (4.4 psi) = 20 mA value

Prerequisite:

This is a theoretical adjustment, i.e. the pressure values for the lower and upper range are known. It is not necessary to apply pressure.

 Due to the orientation of the device, there may be pressure shifts in the measured value, i.e. the measured value is not zero in an unpressurized state. For information on how to perform position adjustment, see the "Performing position adjustment" section →  42.

 For a description of the parameters mentioned and possible error messages, see the "Description of device parameters" section →  63 and →  48.

Performing adjustment

1. Select a pressure unit, here "bar" for example, via the **Unit changeover (UNI)** parameter.
2. Select **Value for 4 mA (STL)** parameter. Enter the value (0 bar (0 psi)) and confirm.
 - ↳ This pressure value is assigned to the lower current value (4 mA).
3. Select **Value for 20 mA (STU)** parameter. Enter the value (300 mbar (4.4 psi)) and confirm.
 - ↳ This pressure value is assigned to the upper current value (20 mA).

The measuring range is configured for 0 to 300 mbar (0 to 4.4 psi).

9.3.2 Adjustment with reference pressure (wet adjustment = adjustment with medium)

Example:



In this example, a device with a 400 mbar (6 psi) sensor is configured for the measuring range 0 to 300 mbar (0 to 4.4 psi).



The following values should be assigned:

- 0 mbar = 4 mA value
- 300 mbar (4.4 psi) = 20 mA value

Prerequisite:

The pressure values 0 mbar and 300 mbar (4.4 psi) can be specified. For example, the device is already installed.

 Due to the orientation of the device, there may be pressure shifts in the measured value, i.e. the measured value is not zero in an unpressurized state. For information on how to perform position adjustment, see the "Performing position adjustment" section →  42.

 For a description of the parameters mentioned and possible error messages, see the "Description of device parameters" section →  63 and →  48.

Performing adjustment

1. Select a pressure unit, here "bar" for example, via the **Unit changeover (UNI)** parameter.
2. The pressure for the LRV (4 mA value) is present at the device, here 0 bar (0 psi) for example. Select **Pressure applied for 4mA (GTL)** parameter. The selection is confirmed by pressing "Get Lower Limit".
 - ↳ The pressure value present is assigned to the lower current value (4 mA).
3. The pressure for the full scale value (20 mA value) is present at the device, here for example 300 mbar (4.4 psi). Select **Pressure applied for 20mA (GTU)** parameter. The selection is confirmed by pressing "Get Lower Limit".
 - ↳ The pressure value present is assigned to the upper current value (20 mA).

The measuring range is configured for 0 to 300 mbar (0 to 4.4 psi).

9.4 Performing position adjustment

Zero point configuration (ZRO)

Navigation	Display: EF → Zero point configuration (ZRO) IO-Link: Parameter → Application → Sensor → Zero point configuration (ZRO)
Description	(Typically absolute pressure sensor) The pressure resulting from the orientation of the device can be corrected here. The pressure difference between zero (set point) and the measured pressure must be known.
Prerequisite	An offset is possible (parallel shifting of the sensor characteristic) to correct the orientation and any zero point drift. The set value of the parameter is subtracted from the "raw measured value". The requirement to be able to perform a zero point shift without changing the span is met with the offset function. Maximum offset value = ± 20 % of the sensor nominal range. If an offset value is entered that shifts the span beyond the physical limits of the sensor, the value is admitted but a warning message is generated and displayed via IO-Link. The warning message only disappears when the span is within the sensor limits, taking the offset value currently configured into consideration. The sensor can <ul style="list-style-type: none"> ▪ be operated in a physically unfavorable range, i.e. outside its specifications, or ▪ be operated by making appropriate corrections to the offset or span. Raw measured value – (manual offset) = display value (measured value)
Example	<ul style="list-style-type: none"> ▪ Measured value = 0.002 bar (0.029 psi) ▪ Set the measured value in the parameter to 0.002. ▪ Measured value (after pos. zero adjust) = 0.000 mbar (0 psi) ▪ The current value is also corrected.
Note	Setting in increments of 0.001. As the value is entered numerically, the increment depends on the measuring range
Options	No selection. The user is free to edit the values.
Factory setting	0

Zero point adoption (GTZ)

Navigation	Display: EF → Zero point adoption (GTZ) IO-Link: Parameter → Application → Sensor → Zero point adoption (GTZ)
Description	(Typically gauge pressure sensor) The pressure resulting from the orientation of the device can be corrected here. The pressure difference between zero (set point) and the measured pressure need not be known.

Prerequisite

The pressure value present is automatically adopted as the zero point. An offset is possible (parallel shifting of the sensor characteristic) to correct the orientation and any zero point drift. The accepted value of the parameter is subtracted from the "raw measured value". The requirement to be able to perform a zero point shift without changing the span is met with the offset function. Maximum offset value = $\pm 20\%$ of the sensor nominal range. If an offset value is entered that shifts the span beyond the physical limits of the sensor, the value is admitted but a warning message is generated and displayed via IO-Link. The warning message only disappears when the span is within the sensor limits, taking the offset value currently configured into consideration.

The sensor can

- be operated in a physically unfavorable range, i.e. outside its specifications, or
- be operated by making appropriate corrections to the offset or span.

Raw measured value – (manual offset) = display value (measured value)

Example 1

- Measured value = 0.002 bar (0.029 psi)
- Use the **Zero point adoption (GTZ)** parameter to correct the measured value with the value, e.g. 0.002 mbar (0.029 psi). This means that you are assigning the value 0.000 (0 psi) to the pressure present.
- Measured value (after pos. zero adjust) = 0.000 mbar (0 psi)
- The current value is also corrected.
- Where applicable, check and correct switch points and span settings.

Example 2

Sensor measuring range: -0.4 to +0.4 bar (-6 to +6 psi) (SP1 = 0.4 bar (6 psi); STU = 0.4 bar (6 psi))

- Measured value = 0.08 bar (1.2 psi)
- Use the **Zero point adoption (GTZ)** parameter to correct the measured value with the value, e.g. 0.08 bar (1.2 psi). This means that you are assigning the value 0 mbar (0 psi) to the pressure present.
- Measured value (after pos. zero adjust) = 0 mbar (0 psi)
- The current value is also corrected.
- Warnings C431 or C432 appear because the value 0 bar (0 psi) was assigned to the real value of 0.08 bar (1.2 psi) present and the sensor measuring range was thus exceeded by $\pm 20\%$.
SP1 and STU values must be readjusted downwards by 0.08 bar (1.2 psi).

9.5 Configuring process monitoring

For process monitoring, it is possible to specify a pressure range which is monitored by the point level switch. Both monitoring versions are described below. The monitoring function allows the user to define optimum ranges for the process (with high yields etc.) and deploy a point level switch to monitor the ranges.

9.5.1 Digital process monitoring (switch output), without Smart Sensor Profile

It is possible to select defined switch points and switchback points which act as NO or NC contacts depending on whether a window function or hysteresis function is configured.

Function	Selection	Output	Abbreviation for operation
Hysteresis	Hysteresis normally open	NO contact	HNO
Hysteresis	Hysteresis normally closed	NC contact	HNC
Window	Window normally open	NO contact	FNO
Window	Window normally closed	NC contact	FNC

If the device is restarted within the given hysteresis, the switch output is open (0 V present at the output).

9.5.2 Digital process monitoring (switch output), with Smart Sensor Profile

It is possible to select defined switch points and switchback points which act as NO or NC contacts depending on whether a window function or hysteresis function is configured.

The "Mode" and "Logic" parameters from the IODD are grouped in the product structure under the "Application Type" parameter. The following table compares the configurations.

Function (IODD: Mode)	Output (IODD: Logic)	Application type	Product structure
Two Point	Two Point normally open	NO contact	TPNO
Two Point	Two point normally closed	NC contact	TPNC
Window	Window normally open	NO contact	WNO
Window	Window normally closed	NC contact	WNC
Single Point	Single Point normally open	NO contact	SPNO
Single Point	Single point normally closed	NC contact	SPNC

If the device is restarted within the given hysteresis, the switch output is open (0 V present at the output).

9.5.3 Analog process monitoring (4 to 20 mA output)

- The 3.8 to 20.5 mA signal range is controlled according to NAMUR NE 43.
- The alarm current and current simulation are exceptions:
 - If the defined limit is exceeded, the device continues measuring linearly. The output current increases linearly up to 20.5 mA and holds the value until the measured value drops below 20.5 mA again or the device detects an error → 48.
 - If the defined limit is undershot, the device continues measuring linearly. The output current decreases linearly to 3.8 mA and holds the value until the measured value rises above 3.8 mA again or the device detects an error → 48.

9.6 Current output

Operating Mode (FUNC)

Navigation	Display: EF → Operating Mode (FUNC) IO-Link: Parameter → Application → Sensor → Operating Mode (FUNC)
Description	Enables the desired behavior of output 2 (not IO-Link output)
Options	Options: <ul style="list-style-type: none"> ■ OFF ■ 4-20 mA (I) (can only be selected if the device has been ordered with 4-20mA) ■ DC-PNP (PNP)

Value for 4 mA (STL)

Navigation	Display: STL → Value for 4 mA (STL) IO-Link: Parameter → Application → Current output → Value for 4 mA (STL)
Description	Assignment of the pressure value which should correspond to the 4 mA value. It is possible to invert the current output. To do so, assign the pressure upper range value to the lower measuring current.
Note	Enter the value for 4 mA in the selected pressure unit anywhere within the measuring range. The value can be entered in increments of 0.1 (increment depends on the measuring range).
Options	No selection. The user is free to edit the values.
Factory setting	0.0 or as per order specifications

Value for 20 mA (STU)

Navigation	Display: STU → Value for 20 mA (STU) IO-Link: Parameter → Application → Current output → Value for 20 mA (STU)
Description	Assignment of the pressure value which should correspond to the 20 mA value. It is possible to invert the current output. To do so, assign the pressure lower range value to the upper measuring current.
Note	Enter the value for 20 mA in the selected pressure unit anywhere within the measuring range. The value can be entered in increments of 0.1 (increment depends on the measuring range).
Options	No selection. The user is free to edit the values.
Factory setting	Upper measuring limit or as per order specifications.

Pressure applied for 4mA (GTL)

Navigation

Display: EF → I → Pressure applied for 4mA (GTL)
 IO-Link: Parameter → Application → Current output → Pressure applied for 4mA (GTL)

Description

The pressure value present is automatically adopted for the 4 mA current signal. Parameter for which the current range can be assigned to any section of the nominal range. This occurs by assigning the pressure lower range value to the lower measuring current and the pressure upper range value to the upper measuring current. The pressure lower range value and upper range value can be configured independently of one another so the pressure measuring span does not remain constant. The LRV and URV pressure measuring span can be edited over the entire sensor range. An invalid TD value is indicated by diagnostic message S510. An invalid position offset is indicated by diagnostic message C431. The editing operation cannot result in the device being operated outside the minimum and maximum sensor limits.

Incorrect entries are declined as indicated by the following messages, and the last valid value prior to the change is used again:

- Parameter value above limit (0x8031)
- Parameter value below limit (0x8032)

The measured value currently present is accepted as the value for 4mA anywhere within the measuring range. The sensor characteristic curve is shifted such that the pressure present becomes the zero value.

Pressure applied for 20mA (GTU)

Navigation

Display: EF → I → Pressure applied for 20mA (GTU)
 IO-Link: Parameter → Application → Current output → Pressure applied for 20mA (GTU)

Description

The pressure value present is automatically adopted for the 20 mA current signal. Parameter for which the current range can be assigned to any section of the nominal range. This occurs by assigning the pressure lower range value to the lower measuring current and the pressure upper range value to the upper measuring current. The pressure lower range value and upper range value can be configured independently of one another so the pressure measuring span does not remain constant. The LRV and URV pressure measuring span can be edited over the entire sensor range. An invalid TD value is indicated by diagnostic message S510. An invalid position offset is indicated by diagnostic message C431. The editing operation cannot result in the device being operated outside the minimum and maximum sensor limits.

Incorrect entries are declined, and the last valid value prior to the change is used again. The measured value currently present is accepted as the value for 20 mA anywhere within the measuring range. There is a parallel shift of the sensor characteristic so that the pressure present becomes the max value.

9.7 Application examples

9.7.1 Compressor control with two-point mode

Example: The compressor is started when the pressure drops below a certain value. The compressor is switched off when a certain value is exceeded.

1. Set the switch point to 2 bar (29 psi)
2. Set the switch-back point to 1 bar (14.5 psi)
3. Configure the switch output as "NC contact" (Mode = Two Point, Logic = High)

The compressor is controlled by the defined settings.

9.7.2 Pump control with two-point mode

Example: The pump should switch on when 2 bar (29 psi) is reached (increasing pressure) and switch off when 1 bar (14.5 psi) is reached (decreasing pressure).

1. Set the switch point to 2 bar (29 psi)
2. Set the switch-back point to 1 bar (14.5 psi)
3. Configure the switch output as a "NO contact" (Mode = Two Point, Logic = High)

The pump is controlled by the defined settings.

10 Diagnosis and troubleshooting

10.1 Troubleshooting

If an illegal configuration exists in the device, the device switches to the failsafe mode.

Example:

- The diagnostic message "C485" is displayed via IO-Link.
- The device is in the simulation mode.
- If the device configuration is corrected, e.g., by resetting the device, the device quits the fault state and switches to the measuring mode.

General errors

Error	Possible cause	Solution
Device is not responding	Supply voltage does not match the voltage specified on the nameplate.	Connect the correct voltage.
	The polarity of the supply voltage is wrong.	Correct the polarity.
	The cables do not contact the terminals properly.	Check for electrical contact between cables and correct.
No display	The local display might be switched off.	Switch on the local display (see the "DOF" parameter description).
Device measures incorrectly.	Parameter configuration error.	Check and adjust parameter configuration.
No communication	<ul style="list-style-type: none"> ■ Communication cable not connected. ■ Communication cable incorrectly attached to device. ■ Communication cable incorrectly attached to the IO-Link master. 	Check wiring and cables.
Output current ≤ 3.6 mA	Signal cable is not wired correctly.	Check wiring.
No transmission of process data	There is an error in the device.	Correct errors that are displayed as a diagnostic event →  50.
Parameter plausibility check has failed (IO-Link message as per IO-Link standard)	An IODD with corresponding default values is used for all pressure measuring ranges. This IODD applies to all measuring ranges! The default values of this IODD may not be valid for this device. IO-Link messages (e.g. "Parameter value above limit") may be displayed when the device is updated with these default values. Existing values are not accepted in this case. The default values apply exclusively to the 10 bar (150 psi) sensor.	Before default values are written from the IODD to the device, the data must first be read from the device.

10.2 Diagnostic events

10.2.1 Diagnostic message

Faults detected by the self-monitoring system of the measuring device are output as a diagnostic message via IO-Link and displayed as a diagnostic message alternately with the measured value.

Status signals

The table →  50 lists the messages that may occur. The ALARM STATUS parameter shows the message with the highest priority. The device has four different status information codes according to NE 107:

F <small>A0013956</small>	"Failure" A device error is present. The measured value is no longer valid.
M <small>A0013957</small>	"Maintenance required" Maintenance is required. The measured value remains valid.
C <small>A0013959</small>	"Function check" The device is in the service mode (e.g. during a simulation).
S <small>A0013958</small>	"Out of specification" The device is being operated: <ul style="list-style-type: none"> ▪ Outside of its technical specifications (e.g. during startup or a cleaning) ▪ Outside of the configuration performed by the user (e.g. level outside configured span)

Diagnostic event and event text

The fault can be identified by means of the diagnostic event.

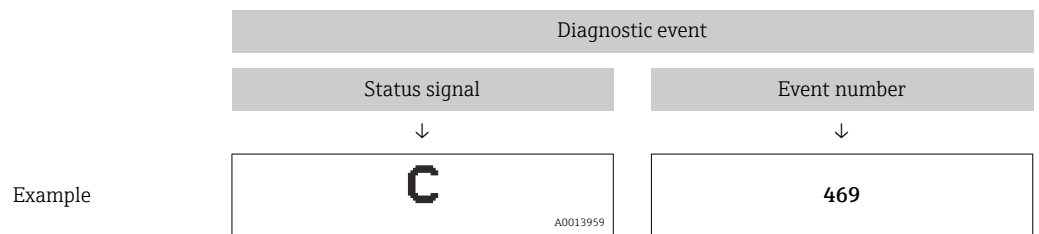

If two or more diagnostic events occur simultaneously, only the diagnostic message with the highest priority is shown.

 The last diagnostic message is displayed - see Last Diagnostic (LST) in the **Diagnosis** submenu.

10.2.2 Overview of diagnostic events

Status signal/ Diagnostic event	Diagnostic behavior	IO-Link EventQualifier	EventCode	Event text	Cause	Remedial measure
S140	Warning	IO-Link warning	0x180F	Sensor signal outside of permitted ranges	Overpressure or low pressure present	Operate device in the specified measuring range
F270 ¹⁾	Fault	IO-Link error	0x1800	Overpressure/low pressure	Overpressure or low pressure present	<ul style="list-style-type: none"> ▪ Check the process pressure ▪ Check the sensor range ▪ Restart device
F270 ¹⁾	Fault	IO-Link error	0x1800	Defect in electronics/sensor	Defect in electronics/sensor	Replace device
C431 ²⁾	Warning	IO-Link warning	0x1805	Invalid position adjustment (Current output)	The adjustment performed would cause the nominal sensor range to be exceeded or undershot.	Position adjustment + parameter of the current output must be within the sensor nominal range <ul style="list-style-type: none"> ▪ Check position adjustment (see Zero point configuration (ZRO) parameter) ▪ Check measuring range (see Value for 20 mA (STU) and Value for 4 mA (STL) parameters)
C432	Warning	IO-Link warning	0x1806	Invalid position adjustment (Switching Output 1)	The adjustment performed leads to switch points being outside the sensor nominal range.	Position adjustment + parameter of the hysteresis and window function must be within the sensor nominal range <ul style="list-style-type: none"> ▪ Check position adjustment (see Zero point configuration (ZRO) parameter) ▪ Check the switch point, switchback point for hysteresis and window function
C432	Warning	IO-Link warning	0x1807	Invalid position adjustment (Switching Output 2)	The adjustment performed leads to switch points being outside the sensor nominal range.	Position adjustment + parameter of the hysteresis and window function must be within the sensor nominal range <ul style="list-style-type: none"> ▪ Check position adjustment (see Zero point configuration (ZRO) parameter) ▪ Check the switch point, switchback point for hysteresis and window function
F437	Fault	IO-Link error	0x1810	Incompatible configuration	Invalid device configuration	<ul style="list-style-type: none"> ▪ Restart device ▪ Reset device ▪ Replace device
C469 Without Smart Sensor Profile	Fault	IO-Link error	0x1803	Switch points for output 1 violated	Switch point ≤ switchback point	Check switch points at output
C469 Without Smart Sensor Profile	Fault	IO-Link error	0x1809	Switch points for output 2 violated	Switch point ≤ switchback point	Check switch points at output
C485	Warning	IO-Link warning	0x8C01 ³⁾	Simulation active	During simulation of the switch output or current output, the device issues a warning message.	Switch off simulation

Status signal/ Diagnostic event	Diagnostic behavior	IO-Link EventQualifier	EventCode	Event text	Cause	Remedial measure
S510	Fault	IO-Link error	0x1802	Turn down violated	A change in the span results in a violation of the turn down (max. TD 5:1) Values for adjustment (lower range value and upper range value) are too close together	<ul style="list-style-type: none"> ▪ Operate device in the specified measuring range ▪ Check the measuring range
S803	Fault	IO-Link error	0x1804	Current loop	Impedance of load resistance at analog output is too high	<ul style="list-style-type: none"> ▪ Check the cabling and load at the current output. ▪ If the current output is not required, switch it off via the configuration. ▪ Connect current output with load. ▪ If the current output is not required, switch it off via the configuration.
F804	Fault	IO-Link error	0x1808	Overload at switch output 1 or 2	Load current too high	<ul style="list-style-type: none"> ▪ Increase load resistance at switch output ▪ Check output circuit
F804	Fault	IO-Link error	0x1808	Overload at switch output 1 or 2	Switch output defective	Replace device
S971	Warning	IO-Link warning	0x1811	Measured value is outside sensor range	The current is outside the permitted range of 3.8 to 20.5 mA. The pressure value is outside the configured measuring range (but may be within the sensor range).	Operate the device within the set span
F419 with Smart Sensor Profile	Fault	IO-Link error	-	Back-2-Box command has been executed.	IO-Link communication no longer available.	Manual restart is necessary

- 1) The switch output is open and the current output adopts the configured alarm current. Errors concerning the switch output are not displayed because the switch output is in a safe state.
- 2) If no remedial measures are taken, the warning messages are displayed following a device restart if configuration (span, switch points and offset) is performed with a gauge pressure device and readings are $> URL + 10\%$ or $< LRL + 5\%$ and with an absolute pressure device and readings are $> URL + 10\%$ or $< LRL$.
- 3) EventCode as per IO-Link standard 1.1

10.3 Behavior of the device in the event of a fault

The device displays warnings and faults via IO-Link. All the device warnings and faults are for information purposes only and do not have a safety function. The errors diagnosed by the device are displayed via IO-Link in accordance with NE 107. Depending on the

diagnostic message, the device behaves as per a warning or fault condition. A distinction must be made between the following types of error here:

- **Warning:**
 - The device continues measuring if this type of error occurs. The output signal is not affected (exception: simulation is active).
 - The local display alternates between the warning and the main measured value.
 - The switch outputs remain in the state defined by the switch points.
 - The status LED flashes red (not for IO-Link).
 - The background remains white in the event of a warning
- **Fault:**
 - The device does **not** continue measuring if this type of error occurs. The output signal adopts its fault state (value in the event of an error - see the following section).
 - The fault state is displayed via IO-Link.
 - The fault state is indicated on the local display.
 - The switch outputs assume the "opened" state.
 - For the analog output option, an error is signaled with the configured alarm current behavior.

10.4 Signal on alarm 4 to 20 mA

The response of the output to error is regulated in accordance with NAMUR NE 43.

The behavior of the current output in the event of errors is defined in the following parameters:

- Alarm Current FCU "MIN": Lower alarm current (≤ 3.6 mA) (optional, see the following table)
 - Alarm Current FCU "MAX" (factory setting): Upper alarm current (≥ 21 mA)
 - Alarm Current FCU "HLD" (HOLD) (optional, see the following table): Last measured current value is held. When the device starts, the current output is set to "Lower alarm current" (≤ 3.6 mA).
-  ■ The selected alarm current is used for all errors.
- Errors and warning messages are displayed via IO-Link.
 - Errors and warning messages are displayed only on the primary value page (topmost display level) and are not displayed in the operating menu.
 - In the operating menu the error is only indicated by the color of the display background.
 - The status LED always indicates an error.
 - It is not possible to acknowledge errors and warnings. The relevant message disappears if the event is no longer pending.
 - The failsafe mode can be changed directly when a device is running (see the following table).

Changing the failsafe mode	After confirming with 
from MAX to MIN	active immediately
from MIN to MAX	active immediately
from HLD (HOLD) to MAX	active immediately
from HLD (HOLD) to MIN	active immediately
from MIN to HLD (HOLD)	active outside the fault state
from MAX to HLD (HOLD)	active outside the fault state

10.5 Behavior of the device in the event of a voltage drop

A diagnostic message is not output. The configuration and the settings made are retained.

10.6 Behavior of the device in the event of an incorrect entry

In the case of incorrect entries, the value entered is not accepted. No fault or warning is issued in this case. The value to be adjusted cannot be changed to a value outside the specified limit. This makes it impossible to configure the device using incorrect values. An exception to this is the configuration of the span that results in a violation of the turn down, which in turn gives rise to a fault state.

10.7 Resetting to factory settings (reset)

See "Standard Command (Restore factory settings)" parameter description.

11 Maintenance

No special maintenance work is required.

Keep the pressure compensation element (1) free from contamination.

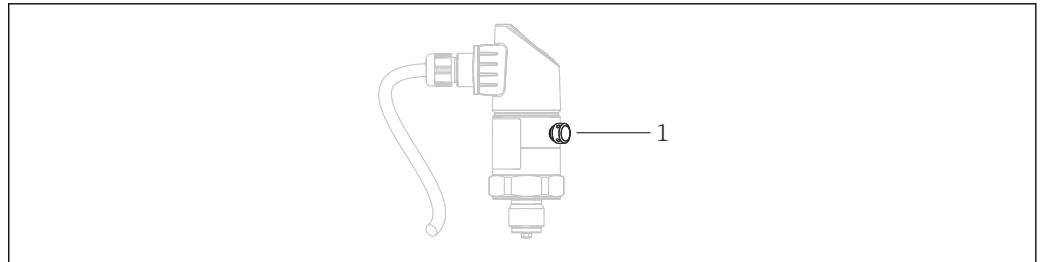

A0022140

11.1 Exterior cleaning

Please note the following points when cleaning the device:

- The cleaning agents used should not corrode the surface and the seals.
- Mechanical damage to the process isolating diaphragm, e.g. due to sharp objects, must be avoided.
- Observe the degree of protection of the device. See the nameplate if necessary →  14.

12 Repair

12.1 General notes

12.1.1 Repair concept

Repairs are not possible.

12.2 Return

The measuring device must be returned if the wrong device has been ordered or delivered.

As an ISO-certified company and also due to legal regulations, Endress+Hauser is obliged to follow certain procedures when handling any returned products that have been in contact with medium. To ensure swift, safe and professional device returns, please read the return procedures and conditions on the Endress+Hauser website at www.services.endress.com/return-material

12.3 Disposal











If required by the Directive 2012/19/EU on waste electrical and electronic equipment (WEEE), the product is marked with the depicted symbol in order to minimize the disposal of WEEE as unsorted municipal waste. Do not dispose of products bearing this marking as unsorted municipal waste. Instead, return them to the manufacturer for disposal under the applicable conditions.

13 Overview of the onsite display operating menu

 Depending on the parameter configuration, not all submenus and parameters are available. Information on this can be found in the parameter description under "Prerequisite".

13.1 Without Smart Sensor Profile

Switch output ¹⁾			Level 0	Level 1	Level 2	Level 3	Description	Details
1 x PNP	2 x PNP	1 x PNP + 4-20 mA						
✓	✓	✓	KYL				If "KYL" is shown on the display, this means that the keys of the device are locked. To unlock the keys, see →  28	
✓	✓	✓	SP1				Switch point value, output 1	
✓	✓	✓	RP1				Switchback point value, output 1	
✓	✓	✓	FH1				Upper value for pressure window, output 1	
✓	✓	✓	FL1				Lower value for pressure window, output 1	
	✓	B ²⁾	SP2				Switch point, output 2	
	✓	B ²⁾	RP2				Switchback point, output 2	
	✓	B ²⁾	FH2				Upper value for pressure window, output 2	
	✓	B ²⁾	FL2				Lower value for pressure window, output 2	
		A ³⁾	STL				Value for 4 mA (LRV)	→  45
		A ³⁾	STU				Value for 20 mA (URV)	→  45
			EF	FUNC			Extended functions	→  45
	✓	✓			OFF			-
		✓			I ⁴⁾			-
	✓	✓			PNP			-
					UNI			
✓	✓	✓			BAR		Unit bar	-
✓	✓	✓			KPA		Unit kPa (depends on the sensor measuring range)	-
✓	✓	✓			MPA		Unit MPa (depends on the sensor measuring range)	-
✓	✓	✓			PSI		Unit psi	-
✓	✓	✓			ZRO		Zero point configuration	→  42
✓	✓	✓			GTZ		Zero point adoption	→  42
✓	✓	✓			TAU		Damping	
		A ³⁾			I		Current output	-
					GTL		Pressure applied for 4mA (LRV)	→  46
					GTU		Pressure applied for 20mA (URV)	→  46
					FCU		Alarm current	
		A ³⁾			MIN		In the event of an error: MIN (≤3.6 mA)	-
		A ³⁾			MAX		In the event of an error: MAX (≥21 mA)	-
		A ³⁾			HLD		Last current value (HOLD)	-
✓	✓	✓			dS1		Switching delay time, output 1	
✓	✓	✓			dR1		Switchback delay time, output 1	
					Ou1		Output 1	-

Switch output ¹⁾			Level 0	Level 1	Level 2	Level 3	Description	Details
1 x PNP	2 x PNP	1 x PNP + 4-20 mA						
✓	✓	✓			HNO		NO contact for hysteresis function	
✓	✓	✓			HNC		NC contact for hysteresis function	
✓	✓	✓			FNO		NO contact for window function	
✓	✓	✓			FNC		NC contact for window function	
	✓	B ²⁾			dS2		Switching delay time, output 2	
	✓	B ²⁾			dR2		Switchback delay time, output 2	
					Ou2		Output 2	-
	✓	B ²⁾			HNO		NO contact for hysteresis function	
	✓	B ²⁾			HNC		NC contact for hysteresis function	
	✓	B ²⁾			FNO		NO contact for window function	
	✓	B ²⁾			FNC		NC contact for window function	
✓	✓	✓			HI		Max value (maximum indicator)	
✓	✓	✓			LO		Min value (minimum indicator)	
✓	✓	✓			RVC		Revision counter	
✓	✓	✓			RES		Reset	
					ADM		Administration	-
✓	✓	✓			LCK		Unlocking code	
✓	✓	✓			COD		Locking code	
					DIS		Display	-
✓	✓	✓			DVA	PV	Display measured value	→ ⓘ 81
		A ³⁾				PV/,	Display the measured value as a percentage of the set span	-
✓	✓	✓				SP	Display set switch point	-
✓	✓	✓			DRO		Display measured value rotated by 180°	→ ⓘ 82
✓	✓	✓			DOF		Display off	→ ⓘ 82
					DIAG		Diagnosis	-
✓	✓	✓			STA		Current device status	
✓	✓	✓			LST		Last device status	
					SM1		Simulation output 1	
✓	✓	✓				OFF		-
✓	✓	✓				OPN	Switch output opened	-
✓	✓	✓				CLS	Switch output closed	-
					SM2 ⁵⁾		Simulation output 2	
							Simulation current output	
	✓	✓				OFF		-
	✓	B ²⁾				OPN	Switch output opened	-
	✓	B ²⁾				CLS	Switch output closed	-
		A ³⁾				3.5	Simulation value for analog output in mA	-
		A ³⁾				4	Simulation value for analog output in mA	-
		A ³⁾				8	Simulation value for analog output in mA	-
		A ³⁾				12	Simulation value for analog output in mA	-

Switch output ¹⁾			Level 0	Level 1	Level 2	Level 3	Description	Details
1 x PNP	2 x PNP	1 x PNP + 4-20 mA						
		A ³⁾			16		Simulation value for analog output in mA	-
		A ³⁾			20		Simulation value for analog output in mA	-
		A ³⁾			21.95		Simulation value for analog output in mA	-

- 1) The assignment of the outputs cannot be modified.
- 2) B = Functionality is active if "PNP" has been configured in the "FUNC" menu.
- 3) A = Functionality is active if "I" has been configured in the "FUNC" menu.
- 4) I can only be selected if the device has been ordered with 4-20 mA.
- 5) For devices with a 4-20 mA current output: can only be selected if the output is switched on.

13.2 With Smart Sensor Profile

Switch output ¹⁾			Level 0	Level 1	Level 2	Level 3	Description	Details
1 x PNP	2 x PNP	1 x PNP + 4 to 20 mA						
✓	✓	✓	KYL	If "KYL" is shown on the display, this means that the keys of the device are locked. To unlock the keys, see → 28				
✓	✓	✓	SSC1	Switch output, output 1				
✓	✓	✓		1SP1	Switch point 1, output 1			
✓	✓	✓		1SP2	Switch point 2, output 1			
✓	✓	✓	1MOD					
✓	✓	✓			TPNO			
✓	✓	✓			TPNC			
✓	✓	✓			WNO			
✓	✓	✓			WNC			
✓	✓	✓			SPNO			
✓	✓	✓			SPNC			
✓	✓	✓			DEAC			
✓	✓	✓		1HYS				
✓	✓	✓		1DS1	Switching delay time, output 1			
✓	✓	✓		1DR1	Switchback delay time, output 1			
	✓		SSC2	Switch output, output 2				
	✓			2SP1	Switch point 1, output 2			
	✓			2SP2	Switch point 2, output 2			
	✓		2MOD					
	✓				TPNO			
	✓				TPNC			
	✓				WNO			
	✓				WNC			
	✓				SPNC			
	✓				SPNC			
	✓				DEAC			
	✓			2HYS				

Switch output ¹⁾			Level 0	Level 1	Level 2	Level 3	Description	Details
1 x PNP	2 x PNP	1 x PNP + 4 to 20 mA						
	✓			2DS2			Switching delay time, output 2	
	✓			2DR2			Switchback delay time, output 2	
		✓		STL			Value for 4 mA (LRV)	
		✓		STU			Value for 20 mA (URV)	
✓	✓	✓		EF			Extended functions	
✓	✓	✓		FUNC	OFF			
✓	✓	✓			I			
✓	✓	✓			PNP			
✓	✓	✓		UNI			Unit changeover	
✓	✓	✓			BAR		Unit bar	
✓	✓	✓			KPA		Unit kPa (depends on the sensor measuring range)	
✓	✓	✓			PSI		Unit psi	
✓	✓	✓			MPA		Unit MPa (depends on the sensor measuring range)	
✓	✓	✓			ZRO		Zero point configuration	
✓	✓	✓			GTZ		Zero point adoption	
✓	✓	✓			TAU		Damping	
		✓		I			Current output	
		✓			GTL		Pressure applied for 4mA (LRV)	
		✓			GTU		Pressure applied for 20mA (URV)	
		✓			FCU	MIN	In the event of an error: MIN (≤3.6 mA)	
		✓				MAX	In the event of an error: MAX (≥21 mA)	
		✓				HLD	Last current value (HOLD)	
✓	✓	✓			HI		Max value (maximum indicator)	
✓	✓	✓			LO		Min value (minimum indicator)	
✓	✓	✓			RVC		Revision counter	
✓	✓	✓			RES		Reset	
✓	✓	✓			ADM		Administration	
✓	✓	✓				LCK	Unlocking code	
✓	✓	✓				COD	Locking code	
✓	✓	✓			DIS		Display	
✓	✓	✓			DVA	PV	Display measured value	
		✓				PV/,	Display the measured value as a percentage of the set span	
✓	✓	✓				SP1	Display set switch point	
✓	✓	✓				DRO	Display measured value rotated by 180°	
✓	✓	✓				DOF	Display off	
✓	✓	✓		DIAG			Diagnosis	
✓	✓	✓			STA		Current device status	
✓	✓	✓			LST		Last device status	
✓	✓	✓			SM1		Simulation output 1	
✓	✓	✓				OFF		
✓	✓	✓				OPN	Switch output opened	

Switch output ¹⁾			Level 0	Level 1	Level 2	Level 3	Description	Details
1 x PNP	2 x PNP	1 x PNP + 4 to 20 mA						
✓	✓	✓			CLS		Switch output closed	
	✓	✓		SM2 ²⁾			Simulation output 2	
	✓	✓			OFF			
	✓				OPN		Switch output opened	
	✓				CLS		Switch output closed	
		✓			3.5		Simulation value for analog output in mA	
		✓			4.0		Simulation value for analog output in mA	
		✓			8.0		Simulation value for analog output in mA	
		✓			12.0		Simulation value for analog output in mA	
		✓			16.0		Simulation value for analog output in mA	
		✓			20.0		Simulation value for analog output in mA	
		✓			21.95		Simulation value for analog output in mA	

1) The assignment of the outputs cannot be modified.

2) For devices with a second output: can only be selected if the second output is switched on.

14 Overview of the IO-Link operating menu

i Depending on the parameter configuration, not all submenus and parameters are available. Information on this can be found in the parameter description under "Prerequisite".

14.1 Without Smart Sensor Profile

Level 0	Level 1	Level 2	Level 3	Details	
Identification	Serial number			-	
	Firmware version			-	
	Extended order code			→ ⓘ 63	
	ProductName			-	
	ProductText			-	
	VendorName			-	
	Hardware revision			-	
	ENP_VERSION			→ ⓘ 63	
	Application Specific Tag			→ ⓘ 63	
	Device Type			-	
Diagnosis	Actual Diagnostics (STA)			→ ⓘ 64	
	Last Diagnostic (LST)			→ ⓘ 64	
	Simulation Switch Output (OU1)			→ ⓘ 64	
	Simulation Current Output (OU2)			→ ⓘ 64	
	Simulation Switch Output (OU2)			→ ⓘ 64	
	Device Search			→ ⓘ 64	
Parameter	Application	Sensor	Operating Mode (FUNC)	→ ⓘ 45	
			Unit changeover (UNI)	→ ⓘ 66	
			Zero point configuration (ZRO)	→ ⓘ 42	
			Zero point adoption (GTZ)	→ ⓘ 42	
			Damping (TAU)	→ ⓘ 68	
	Current output			Value for 4 mA (STL)	→ ⓘ 45
				Value for 20 mA (STU)	→ ⓘ 45
				Pressure applied for 4mA (GTL)	→ ⓘ 46
				Pressure applied for 20mA (GTU)	→ ⓘ 46
				Alarm current (FCU)	→ ⓘ 70
	Switch output 1			Switch point value/Upper value for pressure window, output 1 (SP1/FH1)	→ ⓘ 72
				Switchback point value/Lower value for pressure window, output 1 (RP1/FL1)	→ ⓘ 72
				Switching delay time, output 1 (dS1)	→ ⓘ 77
				Switchback delay time, output 1 (dR1)	→ ⓘ 77
				Output 1 (OU1)	→ ⓘ 75
	Switch output 2			Switch point value / Upper value for pressure window, output 2 (SP2 / FH2)	→ ⓘ 72
				Switchback point value / Lower value for pressure window, output 2 (RP2 / FL2)	→ ⓘ 72
				Switching delay time, output 2 (dS2)	→ ⓘ 79
				Switchback delay time, output 2 (dR2)	→ ⓘ 79

Level 0	Level 1	Level 2	Level 3	Details
			Output 2 (OU2)	→ ⓘ 75
	System	Device Management	Hi Max value (maximum indicator)	→ ⓘ 81
			Lo Min value (minimum indicator)	→ ⓘ 81
			Revisioncounter (RVC)	→ ⓘ 81
			Standard Command (Restore factory settings)	→ ⓘ 81
			Device Access Locks.Data Storage Lock	→ ⓘ 81
		User Administration (ADM)	Unlocking code (LCK)	-
			Locking code (COD)	-
			Device Access Lock.Local Parametrization Lock	-
		Display (DIS)	Measured value display (DVA)	→ ⓘ 81
			Display measured value rotated by 180° (DRO)	→ ⓘ 82
			Switch display on or off (DOF)	→ ⓘ 82
Observation	Pressure			→ ⓘ 83
		Switch State Output (Ou1)		→ ⓘ 83
		Switch State Output (Ou2)		→ ⓘ 83

14.2 With Smart Sensor Profile

IO-Link	Level 1	Level 2	Level 3	Details
Identification	Serial Number			-
	Firmware Revision			-
	Extended order code			→ ⓘ 63
	Product Name			-
	Product Text			-
	Vendor Name			-
	Hardware revision			-
	ENP_VERSION			→ ⓘ 63
	Application Specific Tag			→ ⓘ 63
	Function Tag			→ ⓘ 63
	Location Tag			→ ⓘ 63
	Device Type			-
	Diagnosis	Device Status		
Detailed Device Status				→ ⓘ 64
Actual Diagnostics (STA)				→ ⓘ 64
Last Diagnostic (LST)				→ ⓘ 64
Simulation Switch Output (OU1)				→ ⓘ 64
Simulation Current Output (OU2)				→ ⓘ 65
Parameter	Application	Sensor	Operating Mode (FUNC)	(Verweiszil existiert nicht, aber @y.link.required=true)
			Unit changeover (UNI)	→ ⓘ 66
			Zero point configuration (ZRO)	→ ⓘ 66
			Zero point adoption (GTZ)	→ ⓘ 67
			Damping (TAU)	→ ⓘ 68

IO-Link	Level 1	Level 2	Level 3	Details
		Current output	Value for 4 mA (STL)	→ ⓘ 69
			Value for 20 mA (STU)	→ ⓘ 69
			Pressure applied for 4mA (GTL)	→ ⓘ 69
			Pressure applied for 20mA (GTU)	→ ⓘ 70
			Alarm current (FCU)	→ ⓘ 70
	Teach - Single Value	Teach Select		→ ⓘ 75
		System Command		→ ⓘ 75
		Teach SP1		→ ⓘ 75
		Teach SP2		→ ⓘ 75
		Teach Result State		→ ⓘ 76
	Switching Signal Channels	Switching Signal Channel 1.1	SSC1.1 Param. SP1	→ ⓘ 76
			SSC1.1 Param. SP2	→ ⓘ 76
			SSC1.1 Config. Logic	→ ⓘ 76
			SSC1.1 Config. Mode	→ ⓘ 76
			SSC1.1 Config. Hyst.	→ ⓘ 77
			Switching delay time, output 1 (dS1)	→ ⓘ 77
			Switchback delay time, output 1 (dR1)	→ ⓘ 77
		Switching Signal Channel 1.2	SSC1.2 Param. SP1	→ ⓘ 77
			SSC1.2 Param. SP2	→ ⓘ 78
			SSC1.2 Config. Logic	→ ⓘ 78
			SSC1.2 Config. Mode	→ ⓘ 78
			SSC1.2 Config. Hyst.	→ ⓘ 78
			Switching delay time, output 2 (dS2)	→ ⓘ 79
			Switchback delay time, output 2 (dR2)	→ ⓘ 79
	System	Device Management	HI Max value (maximum indicator)	→ ⓘ 81
			LO Min value (minimum indicator)	→ ⓘ 81
			Revisioncounter (RVC)	→ ⓘ 81
			Reset to factory settings (RES)	→ ⓘ 81
			Back-to-box	→ ⓘ 82
Observation	Pressure			→ ⓘ 83
	Condensed Status			→ ⓘ 83
	Switch State Output (OU1)			→ ⓘ 83
	Switch State Output (OU2)			→ ⓘ 83

15 Description of device parameters

15.1 Identification

Extended order code

Navigation	Identification → Extended order code
Description	Used to replace (reorder) the device. Displays the extended order code (max. 60 alphanumeric characters).
Factory setting	As per order specifications

ENP_VERSION

Navigation	Identification → ENP_VERSION
Description	Displays the ENP version (ENP: electronic name plate)

Application Specific Tag

Navigation	Identification → Application Specific Tag
Description	Used for unique identification of device in the field. Enter device tag (max. 32 alphanumeric characters).
Factory setting	As per order specifications

Function Tag ¹⁾

1) Only with Smart Sensor Profile

Navigation	Identification → Function Tag
Description	Functional description

Location Tag ¹⁾

1) Only with Smart Sensor Profile

Navigation	Identification → Location Tag
Description	Location identification

15.2 Diagnosis

Device Status ¹⁾

1) Only with Smart Sensor Profile

Navigation Diagnosis → Diagnosis → Device Status

Description Current device status

Selection ■ 0 = Device OK
 ■ 1 = Maintenance required
 ■ 2 = Out of specification
 ■ 3 = Functional test
 ■ 4 = Error

Detailed Device Status ¹⁾

1) Only with Smart Sensor Profile

Navigation Diagnosis → Diagnostic → Detailed Device Status

Description Events currently pending

Actual Diagnostics (STA)

Navigation Diagnosis → Actual Diagnostics (STA)

Description Displays the current device status.

Last Diagnostic (LST)

Navigation Diagnosis → Last Diagnostic (LST)

Description Displays the last device status (error or warning) that was rectified during operation.

Simulation Switch Output (OU1)

Navigation Diagnosis → Simulation Switch Output (OU1)

Description	The simulation affects the process data only. It does not affect the physical switch output. If a simulation is active, a warning to this effect is displayed so that it is obvious to the user that the device is in the simulation mode. A warning is communicated via IO-Link (C485 - simulation active). The simulation must be ended actively via the menu. If the device is disconnected from the power supply during the simulation and power is then resupplied, the simulation mode is not resumed, and instead the device continues operation in the measuring mode.
Options	<ul style="list-style-type: none">■ OFF■ OU1 = low (OPN)■ OU1 = high (CLS)

Simulation Current Output (OU2)

Navigation	Diagnosis → Simulation Current Output (OU2)
Description	Simulation affects the process data and the physical current output. If a simulation is active, a warning to this effect is displayed so that it is obvious to the user that the device is in the simulation mode. A warning is communicated via IO-Link (C485 - simulation active). The simulation must be ended actively via the menu. If the device is disconnected from the power supply during the simulation and then power is resupplied afterwards, the simulation mode is not resumed, and instead the device continues operation in the measuring mode.
Options	<ul style="list-style-type: none">■ OFF■ 3.5 mA■ 4 mA■ 8 mA■ 12 mA■ 16 mA■ 20 mA■ 21.95 mA

15.3 Parameter

15.3.1 Application

Sensor

Unit changeover (UNI)

Navigation	Parameter → Application → Sensor → Unit changeover (UNI)
Description	Select the pressure engineering unit. If a new pressure engineering unit is selected, all pressure-specific parameters are converted.
Switch on value	Depends on order specifications.
Options	<ul style="list-style-type: none"> ■ bar ■ kPa ■ Mpa ■ psi
Factory setting	Depends on order specifications.

Zero point configuration (ZRO)

Navigation	Parameter → Application → Sensor → Zero point configuration (ZRO)
Description	<p>(Typically absolute pressure sensor)</p> <p>A pressure shift resulting from the orientation of the device can be corrected by the position adjustment.</p> <p>The pressure difference between zero (set point) and the measured pressure must be known.</p>
Prerequisite	<p>An offset is possible (parallel shifting of the sensor characteristic) to correct the orientation and any zero point drift. The set value of the parameter is subtracted from the "raw measured value". The requirement to be able to perform a zero point shift without changing the span is met with the offset function.</p> <p>Maximum offset value = $\pm 20\%$ of the sensor nominal range.</p> <p>If an offset value is entered that shifts the span beyond the physical limits of the sensor, the value is admitted but a warning message is generated and displayed via IO-Link. The warning message only disappears when the span is within the sensor limits, taking the offset value currently configured into consideration.</p> <p>The sensor can</p> <ul style="list-style-type: none"> ■ be operated in a physically unfavorable range, i.e. outside its specifications, or ■ be operated by making appropriate corrections to the offset or span. <p>Raw measured value – (manual offset) = display value (measured value)</p>
Example	<ul style="list-style-type: none"> ■ Measured value = 0.002 bar (0.029 psi) ■ Set the manual offset to 0.002. ■ Display value (measured value) after position adjustment = 0 bar (0 psi) ■ The current value is also corrected.

Note	Setting in increments of 0.001. As the value is entered numerically, the increment depends on the measuring range
Options	No selection. The user is free to edit the values.
Factory setting	0

Zero point adoption (GTZ)

Navigation	Parameter → Application → Sensor → Zero point adoption (GTZ)
Description	<p>(Typically gauge pressure sensor)</p> <p>A pressure shift resulting from the orientation of the device can be corrected by the position adjustment.</p> <p>The pressure difference between zero (set point) and the measured pressure need not be known.</p>
Prerequisite	<p>The pressure value present is automatically adopted as the zero point.</p> <p>An offset is possible (parallel shifting of the sensor characteristic) to correct the orientation and any zero point drift. The accepted value of the parameter is subtracted from the "raw measured value". The requirement to be able to perform a zero point shift without changing the span is met with the offset function.</p> <p>Maximum offset value = $\pm 20\%$ of the sensor nominal range.</p> <p>If an offset value is entered that shifts the span beyond the physical limits of the sensor, the value is admitted but a warning message is generated and displayed via IO-Link. The warning message only disappears when the span is within the sensor limits, taking the offset value currently configured into consideration.</p> <p>The sensor can</p> <ul style="list-style-type: none"> ■ be operated in a physically unfavorable range, i.e. outside its specifications, or ■ be operated by making appropriate corrections to the offset or span. <p>Raw measured value – (manual offset) = display value (measured value)</p>
Example 1	<ul style="list-style-type: none"> ■ Measured value = 0.002 bar (0.029 psi) ■ Use the Zero point adoption (GTZ) parameter to correct the measured value with the value, e.g. 0.002 bar (0.029 psi). This means that you are assigning the value 0 bar (0 psi) to the pressure present. ■ Display value (measured value) after position adjustment = 0 bar (0 psi) ■ The current value is also corrected. ■ Where applicable, check and correct switch points and span settings.
Example 2	<p>Sensor measuring range: -0.4 to +0.4 bar (-6 to +6 psi) (SP1 = 0.4 bar (6 psi); STU = 0.4 bar (6 psi))</p> <ul style="list-style-type: none"> ■ Measured value = 0.08 bar (1.2 psi) ■ Use the Zero point adoption (GTZ) parameter to correct the measured value with the value, e.g. 0.08 bar (1.2 psi). This means that you are assigning the value 0 mbar (0 psi) to the pressure present. ■ Display value (measured value) after position adjustment = 0 bar (0 psi) ■ The current value is also corrected. ■ Warnings C431 or C432 appear because the value 0 bar (0 psi) was assigned to the real value of 0.08 bar (1.2 psi) present and the sensor measuring range was thus exceeded by $\pm 20\%$. <p>SP1 and STU values must be readjusted downwards by 0.08 bar (1.2 psi).</p>

Damping (TAU)

Navigation	Parameter → Application → Sensor → Damping (TAU)
Description	The damping affects the speed at which the measured value reacts to changes in pressure.
Input range	0.0 to 999.9 seconds in increments of 0.1 seconds
Factory setting	2 seconds

Current output

Value for 4 mA (STL)

Navigation	Parameter → Application → Current output → Value for 4 mA (STL)
Description	Assignment of the pressure value which should correspond to the 4 mA value. It is possible to invert the current output. To do so, assign the pressure upper range value to the lower measuring current.
Note	Enter the value for 4 mA in the selected pressure unit anywhere within the measuring range. The value can be entered in increments of 0.1 (increment depends on the measuring range).
Options	No selection. The user is free to edit the values.
Factory setting	0.0 or as per order specifications

Value for 20 mA (STU)

Navigation	Parameter → Application → Current output → Value for 20 mA (STU)
Description	Assignment of the pressure value which should correspond to the 20 mA value. It is possible to invert the current output. To do so, assign the pressure lower range value to the upper measuring current.
Note	Enter the value for 20 mA in the selected pressure unit anywhere within the measuring range. The value can be entered in increments of 0.1 (increment depends on the measuring range).
Options	No selection. The user is free to edit the values.
Factory setting	Upper measuring limit or as per order specifications.

Pressure applied for 4mA (GTL)

Navigation	Parameter → Application → Current output → Pressure applied for 4mA (GTL)
-------------------	---

Description

The pressure value present is automatically adopted for the 4 mA current signal. Parameter for which the current range can be assigned to any section of the nominal range. This occurs by assigning the pressure lower range value to the lower measuring current and the pressure upper range value to the upper measuring current. The pressure lower range value and upper range value can be configured independently of one another so the pressure measuring span does not remain constant. The LRV and URV pressure measuring span can be edited over the entire sensor range. An invalid TD value is indicated by diagnostic message S510. An invalid position offset is indicated by diagnostic message C431. The editing operation cannot result in the device being operated outside the minimum and maximum sensor limits.

Incorrect entries are declined as indicated by the following messages, and the last valid value prior to the change is used again:

- Parameter value above limit (0x8031)
- Parameter value below limit (0x8032)

The measured value currently present is accepted as the value for 4mA anywhere within the measuring range. The sensor characteristic curve is shifted such that the pressure present becomes the zero value.

Pressure applied for 20mA (GTU)

Navigation

Parameter → Application → Current output → Pressure applied for 20mA (GTU)

Description

The pressure value present is automatically adopted for the 20 mA current signal. Parameter for which the current range can be assigned to any section of the nominal range. This occurs by assigning the pressure lower range value to the lower measuring current and the pressure upper range value to the upper measuring current. The pressure lower range value and upper range value can be configured independently of one another so the pressure measuring span does not remain constant. The LRV and URV pressure measuring span can be edited over the entire sensor range. An invalid TD value is indicated by diagnostic message S510. An invalid position offset is indicated by diagnostic message C431. The editing operation cannot result in the device being operated outside the minimum and maximum sensor limits. Incorrect entries are declined, and the last valid value prior to the change is used again. The measured value currently present is accepted as the value for 20 mA anywhere within the measuring range. There is a parallel shift of the sensor characteristic so that the pressure present becomes the max value.

Alarm current (FCU)

Navigation

Parameter → Application → Current output → Alarm current (FCU)

Description

The device displays warnings and faults. This is done via IO-Link using the diagnostic message stored in the device. The purpose of all device diagnostics is solely to provide information to the user; they do not have a safety function. The errors diagnosed by the device are displayed via IO-Link in accordance with NE 107. In accordance with the diagnostic message, the device behaves as per a warning or fault condition:

Warning (S971, S140, C485, C431, C432):

With this type of error, the device continues to measure. The output signal does not adopt its fault state (value in the event of an error). The main measured value and the state in the form of the letter plus a defined number are displayed alternately (0.5 Hz) via IO-Link. The switch outputs remain in the state defined by the switch points.

Fault (F437, S803, F270, S510, C469¹⁾, F804):

With this type of error, the device does not continue to measure. The output signal adopts its fault state (value in the event of an error). The fault state is displayed via IO-Link in the form of the letter plus a defined number. The switch output changes to the defined state (open). For the analog output option, an error is also signaled and transmitted via the 4 to 20 mA signal. In NE 43, NAMUR defines a current ≤ 3.6 mA and ≥ 21 mA as a device failure. A corresponding diagnostic message is displayed. Current levels available for selection:

The selected alarm current is used for all errors. Diagnostic messages are displayed with numbers and letter via IO-Link. It is not possible to acknowledge all the diagnostic messages. The relevant message disappears if the event is no longer pending.

The messages are displayed in order of priority:

- Highest priority = first message displayed
- Lowest priority = last message displayed

1) Only without Smart Sensor Profile

Selection

- Min: Lower alarm current (≤ 3.6 mA)
- Max: Upper alarm current (≥ 21 mA)

Factory setting

Max or as per order specifications

Switch output 1

Behavior of switch output

Switch point value/Upper value for pressure window, output 1 (SP1/FH1) ¹⁾
Switchback point value/Lower value for pressure window, output 1 (RP1/FL1) ¹⁾

1) Without Smart Sensor Profile

Navigation

Parameter → Application → Switch output 1 → Switch point value.../Switchback point value...

Prerequisite

The following functions are available only if a hysteresis function has been configured for the switch output (output 1 (Ou1)).

Description of behavior of SP1/RP1

The hysteresis is implemented using the **SP1** and **RP1** parameters. Since the parameter settings depend on one another, the parameters are described all together. The switch point "SP1" and switchback point "RP1" can be defined with these functions (e.g., for pump control). When the set switch point "SP1" is reached (with increasing pressure), an electrical signal change takes place at the switch output. When the set switchback point "RP1" is reached (with decreasing pressure), an electrical signal change takes place at the switch output. The difference between the value of switch point "SP1" and the value of switchback point "RP1" is known as the hysteresis. The configured value for the switch point "SP1" must be greater than the switchback point "RP1"! A diagnostic message is displayed if a switch point "SP1" is entered that is \leq the switchback point "RP1". While it is possible to make this entry, it does not take effect in the device. The entry must be corrected!

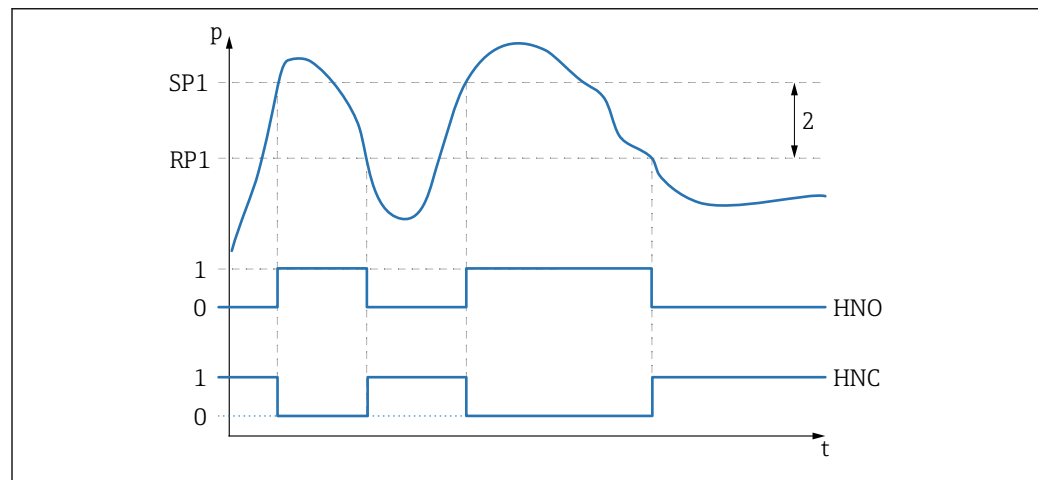

A0034025

0 0-signal. Output open in quiescent state.
 1 1-signal. Output closed in quiescent state.
 2 Hysteresis
 SP1 Switch point
 RP1 Switchback point
 HNO NO contact
 HNC NC contact

i To prevent switch-on and switch-off if values are around the switch point "SP1" or switchback point "RP1", a delay can be set for the relevant points. In this regard, see the **Switching delay time, output 1 (dS1)** and **Switchback delay time, output 1 (dR1)** parameter descriptions.

Prerequisite

The following functions are available only if a window function has been configured for the switch output (output 1 (Ou1)).

Description of behavior of FH1/FL1

The window function is implemented using the **FH1** and **FL1** parameters. Since the parameter settings depend on one another, the parameters are described all together. The upper value of the pressure window "FH1" and the lower value of the pressure window "FL1" can be defined with these functions (e.g., for monitoring a certain pressure range). When the lower value of the pressure window "FL1" is reached (with increasing or decreasing pressure), an electrical signal change takes place at the switch output. When the upper value of the pressure window "FH1" is reached (with increasing or decreasing pressure), an electrical signal change takes place at the switch output. The difference between the upper value of the pressure window "FH1" and the lower value of the pressure window "FL1" is known as the pressure window. The upper value of the pressure window "FH1" must be greater than the lower value of the pressure window "FL1"! A diagnostic message is displayed if the upper value entered for the pressure window "FH1" is less than the lower value of the pressure window "FL1". While it is possible to make this entry, it does not take effect in the device. The entry must be corrected!

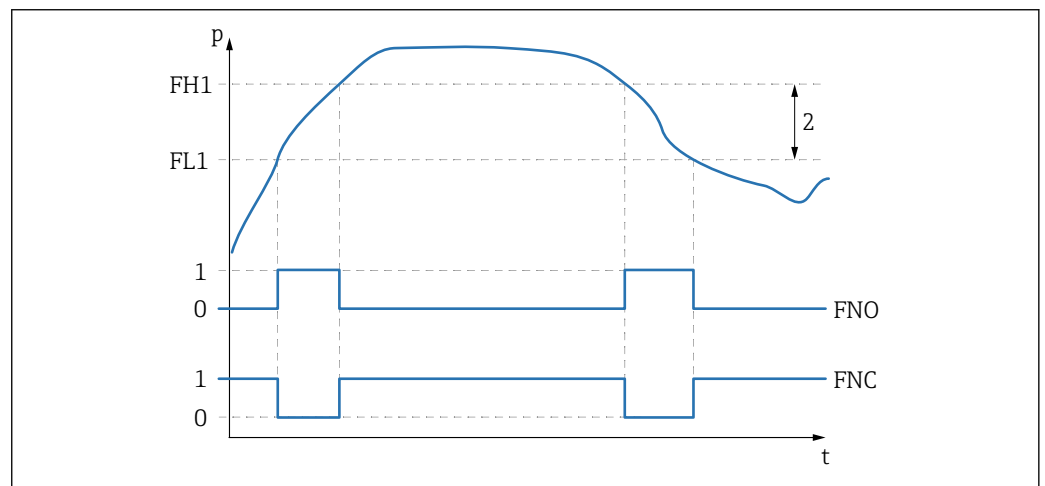

A0034026

- 0 0-signal. Output open in quiescent state.
- 1 1-signal. Output closed in quiescent state.
- 2 Pressure window (difference between the value of the high window "FH1" and the low window "FL1")
- FNO NO contact
- FNC NC contact
- FH1 Upper value of the pressure window
- FL1 Lower value of the pressure window

Selection

No selection. The user is free to edit the values.

Factory setting

Factory setting (if no customer-specific setting is ordered):
 Switch point SP1/FH1: 90%; switchback point RP1/FL1: 10%

*Switching delay***Switching delay time, output 1 (dS1)
Switchback delay time, output 1 (dR1)****Note**

The switching delay time/switchback delay time function is implemented using the **dS1** and **dR1** parameters. Since the parameter settings depend on one another, the parameters are described all together.

- dS1 = switching delay time, output 1
- dR1 = switchback delay time, output 1

Navigation

Parameter → Application → Switch output 1 → Switching delay.../Switchback delay...

Description

To prevent switch-on and switch-off if values are around the switch point "SP1" or the switchback point "RP1", a delay in a range of 0 – 50 seconds, to two decimal places, can be set for the individual points.

If the measured value leaves the switching range during the delay time, the delay time starts again.

Example

- SP1 = 2 bar (29 psi)
- RP1 = 1 bar (14.5 psi)
- dS1 = 5 seconds
- dR1 = 2 seconds

dS1/: ≥ 2 bar (29 psi) must be present for at least 5 seconds for SP1 to become active.
dR1/: ≥ 1 bar (14.5 psi) must be present for at least 2 seconds for RP1 to become active.

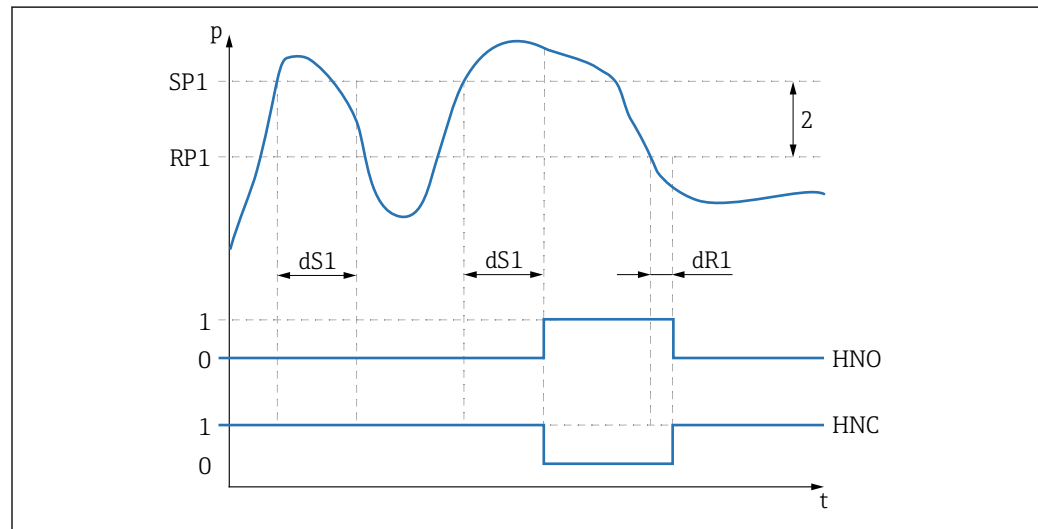

A0034027

0 0-signal. Output open in quiescent state.

1 1-signal. Output closed in quiescent state.

2 Hysteresis (difference between the value of the switch point "SP1" and the value of the switchback point "RP1")

HNO NO contact

HNC NC contact

SP1 Switch point 1

RP1 Switchback point 1

dS1 Set time for which the specific switch point must be reached continuously without interruption until an electrical signal change takes place.

dR1 Set time for which the specific switchback point must be reached continuously without interruption until an electrical signal change takes place.

Input range

0.00 - 50.00 seconds

Factory setting 0

Output 1 (OU1) ¹⁾

1) Without Smart Sensor Profile

Navigation Parameter → Application → Switch output 1 → Output 1 (OU1)

Description

- Hysteresis normally open (HNO):
The switch output is specified as a NO contact with hysteresis properties.
- Hysteresis normally closed (HNC):
The switch output is specified as an NC contact with hysteresis properties.
- Window normally open (FNO):
The switch output is specified as a NO contact with window properties.
- Window normally closed (FNC):
The switch output is specified as an NC contact with window properties.

Selection

- Hysteresis normally open (HNO)
- Hysteresis normally closed (HNC)
- Window normally open (FNO)
- Window normally closed (FNC)

Factory setting Hysteresis normally open (HNO) or as per order specifications
Only with Smart Sensor Profile
Teach Single Value

Teach Select

Navigation Parameter → Teach → Single Value → Teach Select

Description Selection of switching signal to be taught

Selection

- 0 = Default Channel = SSC1.1 Pressure
- 1 = SSC1.1 Pressure
- 2 = SSC1.2 success
- 255 = All SSC

Factory setting 1

Teach SP1

Navigation Parameter → Teach → Single Value → Teach SP1

Description System command (value 65) "Teach switch point 1"

Teach SP2

Navigation Parameter → Teach → Single Value → Teach SP2

Description System command (value 66) "Teach switch point 2"

Teach Result State

Navigation Parameter → Teach → Single Value → Teach Result State

Description Result of the activated system command

Switching Signal Channels

Switching Signal Channel 1.1

SSC1.1 Param. SP1

Navigation Parameter → Signal Switching Channels 1.1 → SSC1.1 Param. SP1

Description Switch point 1 of switching signal SSC1.1 for pressure

Selection No selection. The user is free to edit the values.

SSC1.1 Param. SP2

Navigation Parameter → Signal Switching Channels 1.1 → SSC1.1 Param. SP2

Description Switch point 2 of switching signal SSC1.1 for pressure

Selection No selection. The user is free to edit the values.

SSC1.1 Config. Logic

Navigation Parameter → Signal Switching Channels 1.1 → SSC1.1 Config. Logic

Description Logic for inverting the switching signal SSC1.1 for pressure

Selection ■ 0 = High active
 ■ 1 = Low active

Factory setting 0

SSC1.1 Config. Mode

Navigation Parameter → Signal Switching Channels 1.1 → SSC1.1 Config. Mode

Description Module of switching signal SSC1.1 for pressure

Selection

- 0 = Deactivated
- 1 = Single point
- 2 = Window
- 3 = Two-point

Factory setting 0

SSC1.1 Config. Hyst.

Navigation Parameter → Signal Switching Channels 1.1 → SSC1.1 Config. Hyst.

Description Hysteresis of switching signal SSC1.1 for pressure

Selection No selection. The user is free to edit the values.

Switching delay time, output 1 (dS1)

Navigation Parameter → Signal Switching Channels 1.1 → Switching delay time, output 1 (dS1)

Description To prevent switching on and switching off at values around the switch point, you can configure a delay for the specific points within a range of 0 to 50 s with a resolution of 2 decimal places.
If the measured value leaves the switching range during the configured delay time, the delay time starts again.

Selection 0.00 to 50.00 s

Factory setting 0 s

Switchback delay time, output 1 (dR1)

Navigation Parameter → Signal Switching Channels 1.1 → Switchback delay time, output 1 (dR1)

Description To prevent switching on and switching off at values around the switch-back point, you can configure a delay for the specific points within a range of 0 to 50 s with a resolution of 2 decimal places.
If the measured value leaves the switching range during the configured delay time, the delay time starts again.

Selection 0.00 to 50.00 s

Factory setting 0 s

Switching Signal Channel 1.2

SSC1.2 Param. SP1

Navigation	Parameter → Signal Switching Channels 1.2 → SSC1.2 Param. SP1
Description	Switch point 1 of switching signal SSC1.2 for pressure
Selection	No selection. The user is free to edit the values.

SSC1.2 Param. SP2

Navigation	Parameter → Signal Switching Channels 1.2 → SSC1.2 Param. SP2
Description	Switch point 2 of switching signal SSC1.2 for pressure
Selection	No selection. The user is free to edit the values.

SSC1.2 Config. Logic

Navigation	Parameter → Signal Switching Channels 1.2 → SSC1.2 Config. Logic
Description	Logic for inverting the switching signal SSC1.2 for pressure
Selection	<ul style="list-style-type: none">■ 0 = High active■ 1 = Low active
Factory setting	0

SSC1.2 Config. Mode

Navigation	Parameter → Signal Switching Channels 1.2 → SSC1.2 Config. Mode
Description	Module of switching signal SSC1.2 for pressure
Selection	<ul style="list-style-type: none">■ 0 = Deactivated■ 1 = Single point■ 2 = Window■ 3 = Two-point
Factory setting	0

SSC1.2 Config. Hyst.

Navigation	Parameter → Signal Switching Channels 1.2 → SSC1.2 Config. Hyst.
Description	Hysteresis of switching signal SSC1.2 for pressure
Selection	No selection. The user is free to edit the values.

Switching delay time, output 2 (dS2)

Navigation	Parameter → Signal Switching Channels 1.2 → Switching delay time, output 2 (dS2)
Description	To prevent switching on and switching off at values around the switch point, you can configure a delay for the specific points within a range of 0 to 50 s with a resolution of 2 decimal places. If the measured value leaves the switching range during the configured delay time, the delay time starts again.
Selection	0.00 to 50.00 s
Factory setting	0 s

Switchback delay time, output 2 (dR2)

Navigation	Parameter → Signal Switching Channels 1.2 → Switchback delay time, output 2 (dR2)
Description	To prevent switching on and switching off at values around the switch-back point, you can configure a delay for the specific points within a range of 0 to 50 s with a resolution of 2 decimal places. If the measured value leaves the switching range during the configured delay time, the delay time starts again.
Selection	0.00 to 50.00 s
Factory setting	0 s

Teach Single Value

Teach Select

Navigation	Parameter → Teach → Single Value → Teach Select
Description	Selection of switching signal to be taught
Selection	<ul style="list-style-type: none">■ 0 = Default Channel = SSC1.1 Pressure■ 1 = SSC1.1 Pressure■ 2 = SSC1.2 success■ 255 = All SSC
Factory setting	1

Teach SP1

Navigation	Parameter → Teach → Single Value → Teach SP1
Description	System command (value 65) "Teach switch point 1"

Teach SP2

Navigation	Parameter → Teach → Single Value → Teach SP2
Description	System command (value 66) "Teach switch point 2"

Teach Result State

Navigation	Parameter → Teach → Single Value → Teach Result State
Description	Result of the activated system command

15.3.2 System

HI Max value (maximum indicator)

Navigation	Parameter → System → Device Management → HI Max value (maximum indicator)
Description	This parameter is used as the maximum indicator and makes it possible to call up retroactively the highest value ever measured for pressure. A pressure that is present for at least 2.5 ms is logged to the maximum indicator. The maximum indicators cannot be reset.

LO Min value (minimum indicator)

Navigation	Parameter → System → Device Management → LO Min value (minimum indicator)
Description	This parameter is used as the maximum indicator and makes it possible to call up retroactively the lowest value ever measured for pressure. A pressure that is present for at least 2.5 ms is logged to the maximum indicator. The maximum indicators cannot be reset.

Reset to factory settings (RES)

Navigation	Parameter → System → Device Management → Reset to factory settings (RES)
Description	<p> WARNING</p> <p>"Reset to factory settings" causes an immediate reset to the factory settings of the order configuration (as-delivered state). If the factory settings have been changed, downstream processes might be affected following a reset (the behavior of the switch output or current output might be changed).</p> <ul style="list-style-type: none"> ▶ Make sure that downstream processes are not started unintentionally. <p>The reset is not subject to additional locking, such as in the form of device locking. The reset also depends on the device status. Any customer-specific configuration carried out at the factory is not affected by a reset (customer-specific configuration remains).</p>
Note	The last error is not reset in a reset.

Revisioncounter (RVC)

Navigation	Parameter → System → Device Management → Revisioncounter (RVC)
Description	Counter that indicates the number of parameter changes.

DVA Measured value display

Navigation	Display: Display: EF → DIS → DVA IO-Link: Parameter → System → Display → DVA
Description	Configuration of the measured value display and display of the configured switch point.
Options	<ul style="list-style-type: none"> ■ PV = display measured value ■ PV,/' = display measured value as a percent (only for devices with a current output) <ul style="list-style-type: none"> ■ 0% is equivalent to LRV ■ 100% is equivalent to URV ■ SP1 = display of set switch point
Factory setting	PV

DRO Display measured value rotated by 180°

Navigation	Display: EF → DIS → DRO IO-Link: Parameter → System → Display → DRO
Description	Use this function to rotate the measured value display by 180°.
Options	<ul style="list-style-type: none"> ■ NO ■ YES

DOF Switch display on or off

Navigation	Display: EF → DIS → DOF IO-Link: Parameter → System → Display → DOF
Description	Use this function to switch the display on or off. When the user exits the menu, there is a delay of 30 seconds until the display is switched off (including background lighting).
Options	<ul style="list-style-type: none"> ■ NO ■ YES

Back-to-box

Navigation	Parameter → System → Device Management → Back-to-box
Description	<p>Total reset (IO-link); this code resets all the parameters apart from:</p> <ul style="list-style-type: none"> ■ Revision-counter ■ Peakhold indicator <p>Any simulation that may be running is terminated, the "F419" is displayed and a manual restart is required.</p>

15.4 Observation

The process data →  31 are transmitted acyclically.

16 Accessories

16.1 Weld-in adapter

Various weld-in adapters are available for installation in vessels or pipes.

Device	Description	Option ¹⁾	Order number
PTP33B	Weld-in adapter M24, d=65, 316L	PM	71041381
PTP33B	Weld-in adapter M24, d=65, 316L 3.1 EN10204-3.1 material, inspection certificate	PN	71041383
PTP31B	Weld-in adapter G½, 316L	QA	52002643
PTP31B	Weld-in adapter G½, 316L 3.1 EN10204-3.1 material, inspection certificate	QB	52010172
PTP31B	Weld-in tool adapter G½, brass	QC	52005082
PTP33B	Weld-in adapter G1, 316L, conical metal joint	QE	52005087
PTP33B	Weld-in adapter G1, 316L, 3.1, conical metal joint, EN10204-3.1 material, inspection certificate	QF	52010171
PTP33B	Weld-in tool adapter G1, brass	QG	52005272
PTP33B	Weld-in adapter G1, 316L, silicone O-ring seal	QJ	52001051
PTP33B	Weld-in adapter G1, 316L, 3.1, silicone O-ring seal, EN10204-3.1 material, inspection certificate	QK	52011896

1) Product Configurator, order code for "Accessory enclosed"

If installed horizontally and weld-in adapters with a leakage hole are used, ensure that the leakage hole is pointing down. This allows leaks to be detected as quickly as possible.

16.2 Process adapter M24

The following process adapters can be ordered for the process connections with order option X2J and X3J:

Device	Description	Order number	Order number with inspection certificate 3.1 EN10204
PTP33B	Varivent F DN32 PN40	52023996	52024003
PTP33B	Varivent N DN50 PN40	52023997	52024004
PTP33B	DIN11851 DN40	52023999	52024006
PTP33B	DIN11851 DN50	52023998	52024005
PTP33B	SMS 1½"	52026997	52026999
PTP33B	Clamp 1½"	52023994	52024001
PTP33B	Clamp 2"	52023995	52024002
PTP33B	APV Inline	52024000	52024007

16.3 Flush mount pipe connections M24

Device	Description	Option ¹⁾
PTP33B	Pipe connection DN25 DIN11866, weld-in, flush mount, for devices with M24 connection	QS
PTP33B	Pipe connection DN25 DIN11866, Clamp DIN32676, flush mount, for devices with M24 connection	QT

Device	Description	Option ¹⁾
PTP33B	Pipe connection DN32 DIN11866, weld-in, flush mount, for devices with M24 connection	QU
PTP33B	Pipe connection DN32 DIN11866, Clamp DIN32676, flush mount, for devices with M24 connection	QV
PTP33B	Pipe connection DN40 DIN11866, weld-in, flush mount, for devices with M24 connection	QW
PTP33B	Pipe connection DN40 DIN11866, Clamp DIN32676, flush mount, for devices with M24 connection	QX
PTP33B	Pipe connection DN50 DIN11866, weld-in, flush mount, for devices with M24 connection	QY
PTP33B	Pipe connection DN50 DIN11866, Clamp DIN32676, flush mount, for devices with M24 connection	QZ

1) Product Configurator, order code for "Accessory enclosed"

16.4 M12 plug-in jack

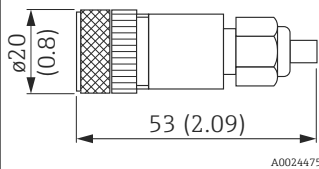
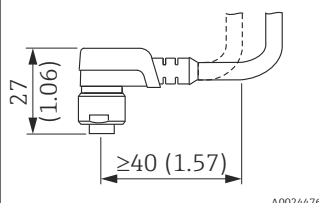
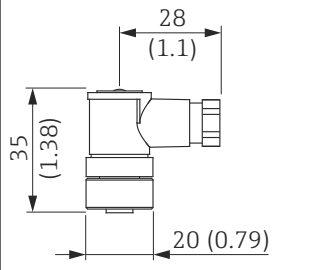
Plug	Degree of protection	Material	Option ¹⁾	Order number
M12 (self-terminated connection at M12 plug) 	IP67	<ul style="list-style-type: none"> ■ Union nut: Cu Sn/Ni ■ Body: PBT ■ Seal: NBR 	R1	52006263
M12 90 degrees with 5m (16 ft) cable 	IP67	<ul style="list-style-type: none"> ■ Union nut: GD Zn/Ni ■ Body: PUR ■ Cable: PVC Cable colors <ul style="list-style-type: none"> ■ 1 = BN = brown ■ 2 = WT = white ■ 3 = BU = blue ■ 4 = BK = black 	RZ	52010285
M12 90 degrees (self-terminated connection at M12 plug) 	IP67	<ul style="list-style-type: none"> ■ Union nut: GD Zn/Ni ■ Body: PBT ■ Seal: NBR 	RM	71114212

1) Product Configurator, order code for "Accessory enclosed"

Index

A

Actual Diagnostics (STA)	64
Alarm current (FCU)	70
Application	9
Application Specific Tag	63

B

Back-to-box	82
-----------------------	----

C

CE mark (Declaration of Conformity)	10
Cleaning	53
Configuration of a pressure measurement	40
Configuring pressure measurement	40

D

Damping (TAU)	68
Declaration of Conformity	10
Detailed Device Status	64
Device Status	64
Diagnosis	
Symbols	49
Diagnostic event	49
Diagnostic events	49
Diagnostic message	49
Disposal	54
DOF	82
DRO	82
DVA	81

E

ENP_VERSION	63
Event text	49
Extended order code	63
Exterior cleaning	53

F

Field of application	
Residual risks	9
Function Tag	63

H

HI Max value (maximum indicator)	81
Hysteresis	72

I

In alarm condition	49
Intended use	9
IO-Link menu	
Overview	60
IO-Link operating menu	
Overview	60

L

Last Diagnostic (LST)	64
LO Min value (minimum indicator)	81

Local display

- see Diagnostic message
- see In alarm condition

Location Tag	63
------------------------	----

M

Maintenance	53
Media	9
Menu	
Parameter description	63

N

Nameplate	14
---------------------	----

O

Onsite display menu	
Overview	55
Onsite display operating menu	
Overview	55
Operating menu	
Parameter description	63
Operating Mode (FUNC)	45
Operational safety	10
Output 1 (OU1)	75

P

Pressure applied for 4mA (GTL)	46, 69
Pressure applied for 20mA (GTU)	46, 70
Product safety	10

R

Repair concept	54
Reset to factory settings (RES)	81
Revisioncounter (RVC)	81

S

Safety instructions	
Basic	9
Simulation Current Output (OU2)	65
Simulation Switch Output 1 (OU1)	64
SSC1.1 Config. Hyst.	77
SSC1.1 Config. Logic	76
SSC1.1 Config. Mode	76
SSC1.1 Param. SP1	76
SSC1.1 Param. SP2	76
SSC1.2 Config. Hyst.	78
SSC1.2 Config. Logic	78
SSC1.2 Config. Mode	78
SSC1.2 Param. SP1	77
SSC1.2 Param. SP2	78
Staff	
Requirements	9
Status signals	49
Switch point value/Upper value for pressure window, output 1 (SP1/FH1)	72
Switchback delay time, output 1 (dR1)	74, 77
Switchback delay time, output 2 (dR2)	79

Switchback point value/Lower value for pressure window, output 1 (RP1/FL1)	72
Switching delay time, output 1 (dS1)	74, 77
Switching delay time, output 2 (dS2)	79
T	
Teach Result State	76, 80
Teach Select	75, 80
Teach SP1	75, 80
Teach SP2	75, 80
Troubleshooting	48
U	
Unit changeover (UNI) - μ C-temperature	66
Use of the measuring device see Intended use	
Use of the measuring devices Borderline cases	9
Incorrect use	9
V	
Value for 4 mA (STL)	45, 69
Value for 20 mA (STU)	45, 69
W	
Window function	72
Workplace safety	10
Z	
Zero point adoption (GTZ)	42, 67
Zero point configuration (ZRO)	42, 66



71621495

www.addresses.endress.com
