

# Operating Instructions

## Liquipoint FTW23

### IO-Link

Capacitance point level measurement

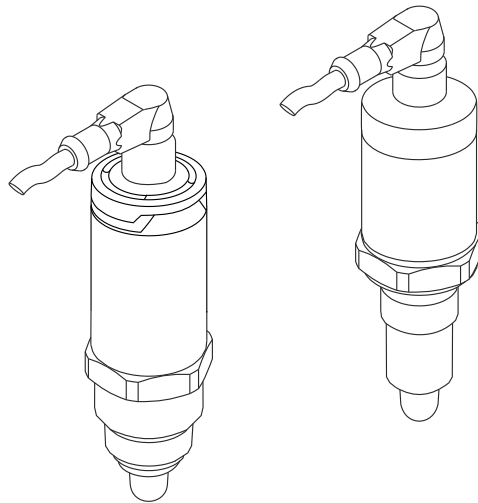

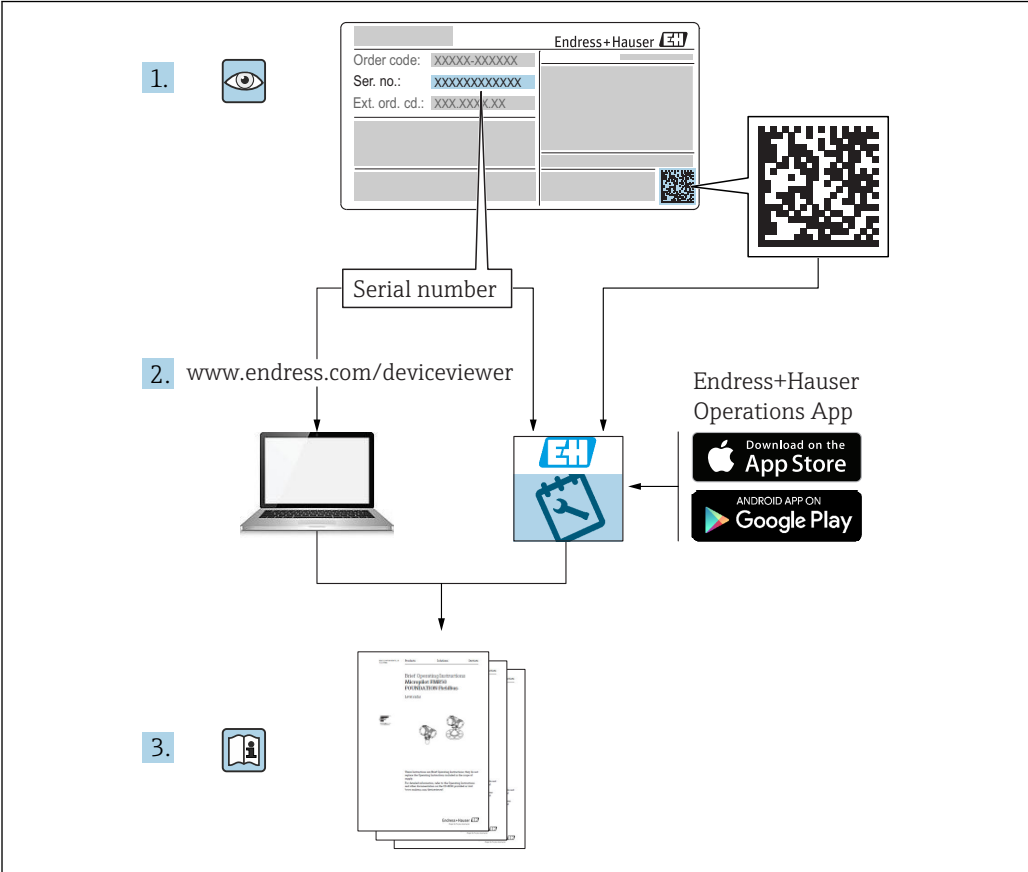

A0023555

## Table of contents

<b>1</b>	<b>Document information</b> .....	<b>4</b>	<b>10</b>	<b>Diagnostics and troubleshooting</b> ...	<b>23</b>
1.1	Document function .....	4	10.1	Troubleshooting .....	23
1.2	Symbols .....	4	10.2	Diagnostic information via LED display .....	23
1.3	Documentation .....	5	10.3	Diagnostic events .....	24
1.4	Registered trademarks .....	5	10.4	Behavior of the device in the event of a fault ..	25
<b>2</b>	<b>Basic safety instructions</b> .....	<b>6</b>	10.5	Resetting to factory settings (reset) .....	25
2.1	Requirements for personnel .....	6	<b>11</b>	<b>Maintenance</b> .....	<b>26</b>
2.2	Designated use .....	6	11.1	Cleaning .....	26
2.3	Operational safety .....	6	<b>12</b>	<b>Repairs</b> .....	<b>26</b>
2.4	Product safety .....	6	12.1	Return .....	26
<b>3</b>	<b>Product description</b> .....	<b>7</b>	12.2	Disposal .....	26
3.1	Product design .....	7	<b>13</b>	<b>Overview of the onsite display operating menu</b> .....	<b>27</b>
<b>4</b>	<b>Incoming acceptance and product identification</b> .....	<b>8</b>	<b>14</b>	<b>Description of Device Parameters</b> ...	<b>28</b>
4.1	Incoming acceptance .....	8	14.1	Identification .....	28
4.2	Product identification .....	8	14.2	Diagnosis .....	29
4.3	Storage and transport .....	9	14.3	Parameter .....	31
<b>5</b>	<b>Installation</b> .....	<b>10</b>	14.4	Observation .....	37
5.1	Installation conditions .....	10	<b>15</b>	<b>Accessories</b> .....	<b>37</b>
5.2	Mounting the measuring device .....	10	<b>Index</b> .....	<b>38</b>	
5.3	Post-installation check .....	11			
<b>6</b>	<b>Electrical connection</b> .....	<b>12</b>			
6.1	Connecting the measuring device .....	12			
6.2	Post-connection check .....	13			
<b>7</b>	<b>Operation options</b> .....	<b>14</b>			
7.1	Operation with an operating menu .....	14			
<b>8</b>	<b>System integration</b> .....	<b>15</b>			
8.1	Process data .....	15			
8.2	Reading out and writing device data (ISDU – Indexed Service Data Unit) .....	15			
8.3	Overview of diagnostic events .....	17			
<b>9</b>	<b>Commissioning</b> .....	<b>17</b>			
9.1	Function check .....	18			
9.2	Commissioning with an operating menu .....	18			
9.3	Hysteresis function, level detection .....	18			
9.4	Window function, media detection/ differentiation .....	19			
9.5	Application example .....	20			
9.6	Light signals (LEDs) .....	21			
9.7	Function of LEDs .....	21			
9.8	Function testing of switch output .....	22			





# 1 Document information

## 1.1 Document function



These Operating Instructions contain all the information that is required in various phases of the life cycle of the device: from product identification, incoming acceptance and storage, to mounting, connection, operation and commissioning through to troubleshooting, maintenance and disposal.

## 1.2 Symbols







### 1.2.1 Safety symbols



Symbol	Meaning
	<b>DANGER!</b> This symbol alerts you to a dangerous situation. Failure to avoid this situation will result in serious or fatal injury.
	<b>WARNING!</b> This symbol alerts you to a dangerous situation. Failure to avoid this situation can result in serious or fatal injury.
	<b>CAUTION!</b> This symbol alerts you to a dangerous situation. Failure to avoid this situation can result in minor or medium injury.
	<b>NOTE!</b> This symbol contains information on procedures and other facts which do not result in personal injury.

### 1.2.2 Electrical symbols

Symbol	Meaning
	<b>Ground connection</b> A grounded terminal which, as far as the operator is concerned, is grounded via a grounding system.
	<b>Protective ground connection</b> A terminal which must be connected to ground prior to establishing any other connections.

### 1.2.3 Symbols for certain types of information

Symbol	Meaning
	<b>Preferred</b> Procedures, processes or actions that are preferred.
	<b>Permitted</b> Procedures, processes or actions that are permitted.
	<b>Forbidden</b> Procedures, processes or actions that are forbidden.
	<b>Tip</b> Indicates additional information.
	Reference to page
	Series of steps

Symbol	Meaning
	Result of a step
	Visual inspection

### 1.2.4 Symbols for graphics

Symbol	Meaning
1, 2, 3 ...	Item numbers
A, B, C, ...	Views

### 1.2.5 Symbols for tools

Symbol	Meaning
	Open-ended wrench

## 1.3 Documentation

The following document types are also available in the Download Area of the Endress +Hauser website: [www.endress.com](http://www.endress.com) → [download](#)

Documentation	Purpose and content of the document
Technical Information TI01202F/00/EN	This document contains all the technical data for the device and provides an overview of the accessories that can be ordered.
Additional documentation TI00426F/00/EN SD01622Z/00/YY BA00361F/00/A6	Weld-in adapter, process adapter and flanges (overview) Weld-in adapter G 1", G ¾" (installation instructions) Weld-in adapter M24x1.5 (installation instructions)

## 1.4 Registered trademarks

 **IO-Link**

is a registered trademark of the IO-Link company group.

## 2 Basic safety instructions

### 2.1 Requirements for personnel

Personnel involved in installation, commissioning, diagnostics and maintenance must meet the following requirements:

- Trained, qualified specialists must have a relevant qualification for this specific function and task
- Are authorized by the plant owner/operator
- Are familiar with federal/national regulations
- Before starting work, read and understand the instructions in the manual and supplementary documentation as well as the certificates (depending on the application)
- Follow instructions and comply with basic conditions

Operating personnel must meet the following requirements:

- Be instructed and authorized by the plant operator with regard to the requirements of the task
- Follow the instructions in this manual

### 2.2 Designated use

The measuring device described in this manual may be used only as a point level switch for water-, alcohol- or oil-based liquids or for powdered products. Incorrect use may pose a hazard. To ensure that the measuring device remains in perfect condition during the operating time:

- Measuring devices must be used only for media to which the process-wetted materials have an adequate level of resistance.
- The relevant limit values must not be violated, see TI01202F/00/EN.

#### 2.2.1 Incorrect use

The manufacturer is not liable for damage caused by improper or non-designated use.

#### Residual risks

Due to heat transfer from the process, the temperature of the electronics housing and the assemblies contained therein may rise to 80 °C (176 °F) during operation.

Danger of burns from contact with surfaces!

- ▶ For elevated fluid temperature, ensure protection against contact to prevent burns.

### 2.3 Operational safety

Risk of injury!

- ▶ Operate the device in proper technical condition and fail-safe condition only.
- ▶ The operator is responsible for interference-free operation of the device.

### 2.4 Product safety

This measuring device is designed in accordance with good engineering practice to meet state-of-the-art safety requirements, has been tested, and left the factory in a condition in which it is safe to operate. It meets general safety standards and legal requirements. It also complies with the EC directives listed in the device-specific EC Declaration of Conformity. Endress+Hauser confirms this by affixing the CE mark to the device.

### 3 Product description

Compact point level switch, preset for water-based liquids; can be adjusted to alcohol- or oil-based liquids and powdered products; to be used preferably in pipes and in storage, mixing and process vessels with or without an agitator.

#### 3.1 Product design

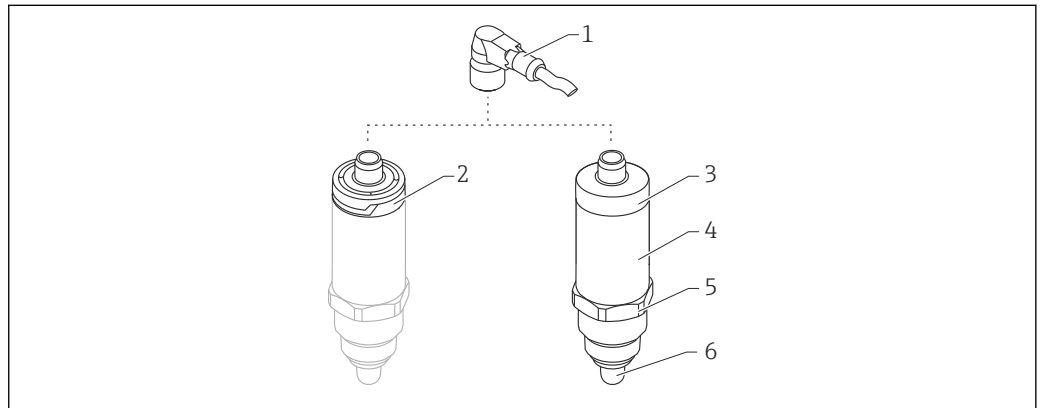

A0024689

#### 1 Product design of Liquipoint FTW23

- 1 M12 connector
- 2 Plastic housing cover IP65/67
- 3 Metal housing cover IP66/68/69
- 4 Housing
- 5 Process connection (G 1/2", G 3/4", G 1", M24x1.5)
- 6 Sensor

## 4 Incoming acceptance and product identification

### 4.1 Incoming acceptance

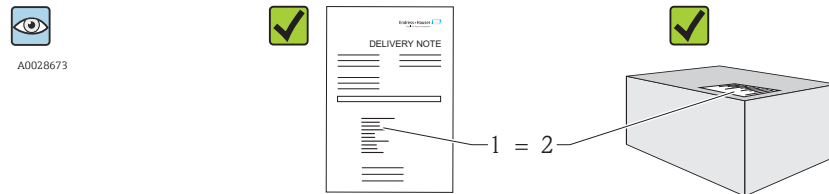

A0016051

Is the order code on the delivery note (1) identical to the order code on the product sticker (2)?

Are the goods undamaged?

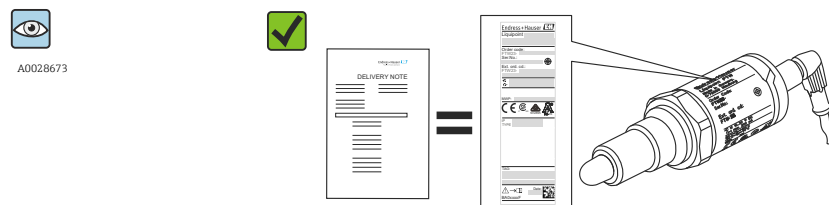

A0024390

Do the data on the nameplates correspond to the order specifications on the delivery note?



If one of these conditions is not satisfied, contact your Sales Center.

### 4.2 Product identification

The following options are available for identification of the measuring device:

- Nameplate data
- Order code with breakdown of the device features on the delivery note
- Enter serial number from nameplates in *W@M Device Viewer*  
([www.endress.com/deviceviewer](http://www.endress.com/deviceviewer)): All information on the measuring device is displayed

The serial number on the nameplate can also be used to obtain an overview of the technical documentation supplied with the device in *W@M Device Viewer*  
([www.endress.com/deviceviewer](http://www.endress.com/deviceviewer))

#### 4.2.1 Manufacturer address

Endress+Hauser GmbH+Co. KG

Hauptstraße 1

79689 Maulburg, Germany

Address of the manufacturing plant: See nameplate.



### 4.2.2 Nameplate

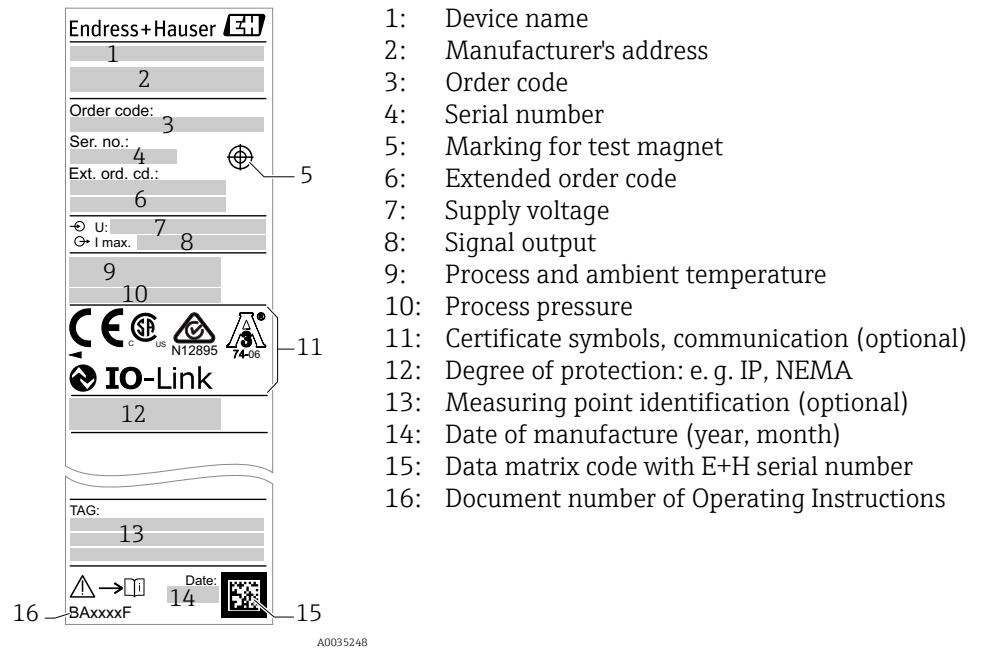

**i** The test magnet is not included in the scope of delivery and can be ordered as an optional accessory → 37.

## 4.3 Storage and transport

### 4.3.1 Storage conditions

- Permitted storage temperature: -40 to +85 °C (-40 to +185 °F)
- Use original packaging.

### 4.3.2 Transportation to measuring point

Transport the device to the measuring point in the original packaging.

## 5 Installation

### 5.1 Installation conditions

- Installation is possible in any position in a vessel, pipe or tank.
- For measuring points that are difficult to access, use a socket wrench.

The socket wrench 32 AF can be ordered as an optional extra →  37.

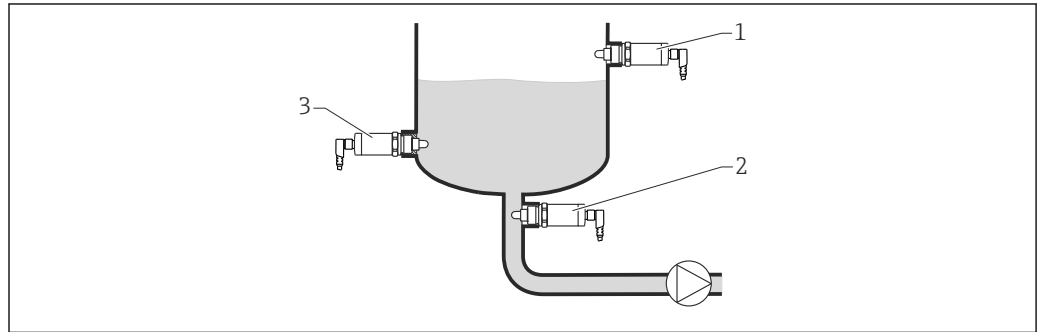

A0016844

#### 2 Installation examples

- 1 Overfill protection or upper level detection (MAX)
- 2 Pump dry running protection (MIN)
- 3 Lower level detection (MIN)

Installation in horizontal pipes:

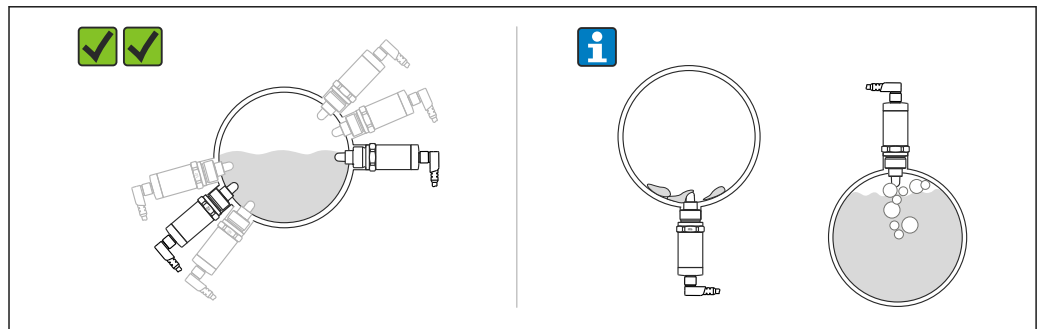

A0021052

#### Vertical installation:

If the sensor is not completely covered by the medium or if there are air bubbles on the sensor, this may interfere with the measurement.

### 5.2 Mounting the measuring device

#### 5.2.1 Required tools

- Open-ended wrench or socket wrench 32 AF
- When screwing in, turn by the hex bolt only.
  - Torque: 15 to 30 Nm (11 to 22 lbf ft)

## 5.2.2 Installation

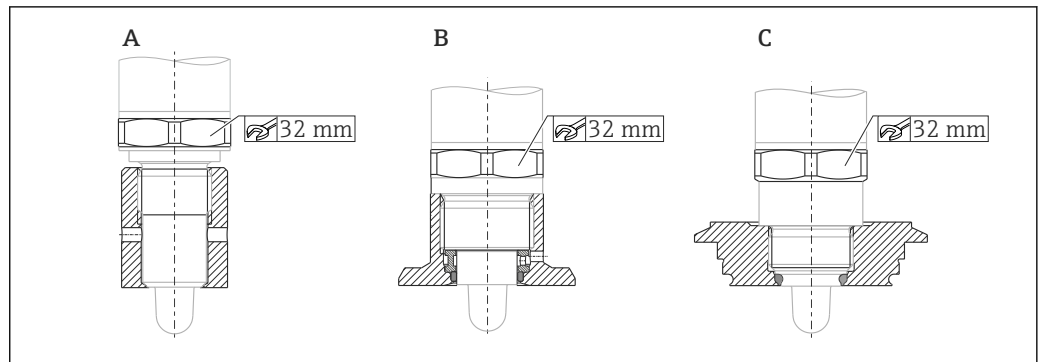

- A Thread G 1/2"  
 B Thread G 3/4"  
 C Thread M24x1.5

**i** Take account of metallic or non-metallic vessels or pipes in accordance with EMC guidelines, see Technical Information TI01202F.

## 5.3 Post-installation check

<input type="checkbox"/>	Is the device undamaged (visual inspection)?
<input type="checkbox"/>	Is the device adequately protected from wet conditions and direct sunlight?
<input type="checkbox"/>	Is the device properly secured?

## 6 Electrical connection

The measuring device has two modes of operation:

- **Maximum point level detection (MAX):** e. g. for overflow protection  
The device keeps the electrical switch closed as long as the sensor is not yet covered by liquid or the measured value is within the process window.
- **Minimum point level detection (MIN):** e. g. to protect pumps from dry running  
The device keeps the electrical switch closed as long as the sensor is covered by liquid or the measured value is outside the process window.

Choosing the MAX or MIN mode of operation ensures that the device switches in a safety-oriented manner even in an alarm condition, e. g. if the power supply line is disconnected. The electronic switch opens if the point level is reached, if a fault occurs or if the power fails (quiescent current principle).





- i** ▪ **IO-Link:** communication on Q1; switch mode on Q2.
- **SIO mode:** if there is no communication, the device switches to the SIO mode = standard IO mode.

The factory-set functions for the MAX and MIN modes can be changed via IO-Link.

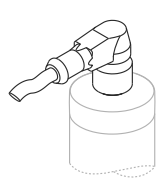
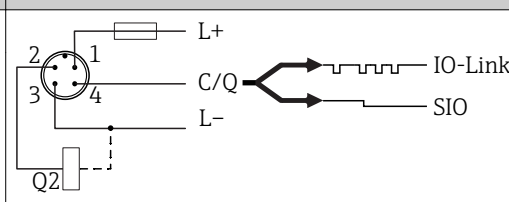
### 6.1 Connecting the measuring device

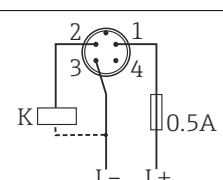
- **Supply voltage 10 to 30 V DC** to a DC power supply.  
IO-Link communication is guaranteed only if the supply voltage is at least 18 V.
- In accordance with IEC/EN61010 a suitable circuit breaker must be provided for the measuring device.
- **Voltage source:** non-hazardous contact voltage or Class 2 circuit (North America).
- The device must be operated with a fine-wire fuse 500 mA (slow-blow).

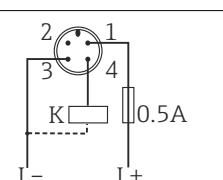
Electrical connection	IO-Link with a switch output
<p>M12 connector</p> 	 <p>1 Supply voltage + 2 DC-PNP (Q2) 3 Supply voltage - 4 C/Q (IO-Link communication or SIO mode)</p>

Electrical connection	Operating mode (SIO mode with factory setting)	
	MAX	MIN
<p>M12 connector</p> 	 <p>  1-2 ●   1-2 ☀                 </p>	 <p>  1-4 ●   1-4 ☀                 </p>
<b>Symbols</b>	<b>Description</b>	
☀	Yellow LED (ye) lit	
●	Yellow LED (ye) not lit	
K	external load	

### Function monitoring

With two-channel evaluation, functional monitoring of the sensor is also possible in addition to level monitoring provided that no other monitoring option has been configured via IO-Link.

When both outputs are connected, the MIN and MAX outputs assume opposite states (XOR) when the device is operating fault-free. In an alarm condition or in the event of a line break, both outputs are de-energized, see following table:

Connection for function monitoring using XOR operation			Yellow LED (ye)	Red LED (rd)										
	Sensor covered	1 / 2 1 / 4	☀	●										
	Sensor uncovered	1 / 2 1 / 4	●	●										
	Fault	1 / 2 1 / 4	●	☀										
<table border="0"> <tr> <td><b>Symbols</b></td> <td><b>Description</b></td> </tr> <tr> <td>☀</td> <td>LED lit</td> </tr> <tr> <td>●</td> <td>LED not lit</td> </tr> <tr> <td></td> <td>Fault or warning</td> </tr> <tr> <td>K1 / K2</td> <td>external load</td> </tr> </table>					<b>Symbols</b>	<b>Description</b>	☀	LED lit	●	LED not lit		Fault or warning	K1 / K2	external load
<b>Symbols</b>	<b>Description</b>													
☀	LED lit													
●	LED not lit													
	Fault or warning													
K1 / K2	external load													

## 6.2 Post-connection check

<input type="checkbox"/>	Is the device or cable undamaged (visual check)?
<input type="checkbox"/>	Do the cables comply with the requirements ?
<input type="checkbox"/>	Do the cables have adequate strain relief?
<input type="checkbox"/>	Are the cable glands mounted and firmly tightened?
<input type="checkbox"/>	Does the supply voltage match the specifications on the nameplate?
<input type="checkbox"/>	If supply voltage is present, is the green LED lit? With IO-Link communication: is the green LED flashing?

## 7 Operation options

### 7.1 Operation with an operating menu

#### 7.1.1 IO-Link

##### IO-Link information

IO-Link is a point-to-point connection for communication between the measuring device and an IO-Link master. The measuring device features an IO-Link communication interface type 2 with a second IO function on pin 4. This requires an IO-Link-compatible assembly (IO-Link master) for operation. The IO-Link communication interface enables direct access to the process and diagnostic data. It also provides the option of configuring the measuring device while in operation.

Physical layer, the measuring devices supports the following features:

- IO-Link specification: version 1.1
- IO-Link Smart Sensor Profile 2nd Edition
- SIO mode: yes
- Speed: COM2; 38.4 kBaud
- Minimum cycle time: 6 msec.
- Process data width: 16 bit
- IO-Link data storage: yes
- Block configuration: no

##### IO-Link download

<http://www.endress.com/download>

- Select "Software" as the media type.
- Select "Device Driver" as the software type.  
Select IO-Link (IODD).
- In the "Text Search" field enter the device name.

<https://ioddfinder.io-link.com/>

Search by

- Manufacturer
- Article number
- Product type

#### 7.1.2 Structure of the operating menu

The menu structure has been implemented according to VDMA 24574-1 and complemented by Endress+Hauser-specific menu items.

 For an overview of the operating menu, see →  27

## 8 System integration

### 8.1 Process data

The measuring device has two switch outputs. Both outputs are transmitted as process data via IO-Link.

- In the SIO mode, switch output 1 is switched at pin 4 of the M12 plug. In the IO-Link communication mode, this pin is reserved exclusively for communication.
- In addition, switch output 2 is always switched at pin 2 of the M12 plug.
- The process data of the point level switch are transmitted cyclically in 16-bit chunks.

Bit	0 (LSB)	1	...	12	13 (MSB)	14	15
Measuring device	Coverage [0 to 16 384], resolution approx. 0.05%					OU1	OU2

Bit 14 reflects the status of switch output 1 and bit 15 the status of switch output 2. Here, the logical state "1" at the specific switch output corresponds to "closed" or  $24 V_{DC}$ .

The remaining 14 bits contain the coverage value [0 to 16 384] following conversion using the calculation factor. The raw value (R) must be converted to the coverage value (C) = Coverage) by the target system.

$$C = \frac{200}{16\,384} * R$$

Bit	Process value	Value range
14	OU1	0 = open 1 = closed
15	OU2	0 = open 1 = closed
0 to 13	Raw measured value, not coverage [0 to 100]	u_Integer

 In addition, the coverage value can be read via ISDU (hex) 0x0028 – acyclic service.

### 8.2 Reading out and writing device data (ISDU – Indexed Service Data Unit)

Device data are always exchanged acyclically and at the request of the IO-Link master. Using the device data, the following parameter values or device statuses can be read out:

#### 8.2.1 Endress+Hauser-specific device data

Designation	ISDU (dec)	ISDU (hex)	Size (byte)	Data type	Access	Default value	Value range	Offset / Gradient	Data storage	Range limits
Extended Ordercode	259	0x0103	60	String	ro					
ENP_VERSION	257	0x0101	16	String	ro	02.03.00				
Active switchpoints	64	0x0040	1	UInt8	r/w	Standard	0 ~ Standard 1 ~ User			

Designation	ISDU (dec)	ISDU (hex)	Size (byte)	Data type	Access	Default value	Value range	Offset / Gradient	Data storage	Range limits
Reset user switchpoints	65	0x0041	1	UIntegerT	r/w	False	0 ~ False 1 ~ Switchpoints OU1 2 ~ Switchpoints OU2			
Simulation switch output (OU1)	89	0x0059	1	UInt8	r/w	Off	0 ~ Off 1 ~ High 2 ~ Low	0 / 0	No	0...2
Simulation switch output (OU2)	68	0x0044	1	UInt8	r/w	Off	0 ~ Off 1 ~ High 2 ~ Low	0 / 0	No	0...2
Device search	69	0x0045	1	UInt8	r/w	Off	0 ~ Off 1 ~ On	0 / 0	No	0...1
Sensor check	70	0x0046	1	UInt8	w	-		0 / 0	No	
Calibrate coverage, Output 1 (OU1)	87	0x0057	1	UInt8	w		1			
Switch point value (Coverage), Output 1 (SP1/FH1)	71	0x0047	2	UInt16	r/w	77.5 %		0 / 0.1	Yes	0...200
Switchback point value (Coverage), Output 1 (rP1/FL1)	72	0x0048	2	UInt16	r/w	73.0 %		0 / 0.1	Yes	0...200
Switching delay time, Output 1 (dS1)	81	0x0051	2	UInt16	r/w	0.5 s		0 / 0.1	Yes	0.3 to 600
Switchback delay time, Output 1 (dR1)	82	0x0052	2	UInt16	r/w	1.0 s		0 / 0.1	Yes	0.3 to 600
Output 1 (OU1)	85	0x0055	1	UInt8	r/w	HNO	0 ~ HNO <sup>1)</sup> 1 ~ HNC <sup>1)</sup> 2 ~ FNO <sup>1)</sup> 3 ~ FNC <sup>1)</sup>		Yes	0 to 3
Calibrate coverage, Output 2 (OU2)	88	0x0058	1	UInt8	w		1			
Switch point value (Coverage), Output 2 (SP2/FH2)	75	0x004B	2	UInt16	r/w	77.5 %		0 / 0.1	Yes	0...200
Switchback point value (Coverage), Output 2 (rP2/FL2)	76	0x004C	2	UInt16	r/w	73.0 %		0 / 0.1	Yes	0...200
Switching delay time, Output 2 (dS2)	83	0x0053	2	UInt16	r/w	0.5 s		0 / 0.1	Yes	0.3 to 600
Switchback delay time, Output 2 (dR2)	84	0x0054	2	UInt16	r/w	1.0 s		0 / 0.1	Yes	0.3 to 600
Output 2 (OU2)	86	0x0056		UInt8	r/w	HNC	0 ~ HNO <sup>1)</sup> 1 ~ HNC <sup>1)</sup> 2 ~ FNO <sup>1)</sup> 3 ~ FNC <sup>1)</sup>			0 to 3
Operating hours	96	0x0060	4	UInt32	r	0		0 / 0.016667	No	0 to 2 <sup>32</sup>
µC-Temperature	91	0x005B	1	Int8	r			°C: 0 / 1 °F: 32 / 1.8 K: 273.15 / 1	No	-128...127
Unit changeover (UNI) - µC-Temperature	80	0x0050	1	UInt8	r/w	°C	0 ~ °C 1 ~ °F 2 ~ K	0 / 0	Yes	0...2



Designation	ISDU (dec)	ISDU (hex)	Size (byte)	Data type	Access	Default value	Value range	Offset / Gradient	Data storage	Range limits
Minimum $\mu$ C-Temperature	92	0x005C	1	Int16	r/w	127		°C: 0 / 1 °F: 32 / 1.8 K: 273.15 / 1	No	-128...127
Maximum $\mu$ C-Temperature	93	0x005D	1	Int16	r/w	-128		°C: 0 / 1 °F: 32 / 1.8 K: 273.15 / 1	No	-128...127

1) For an explanation of the abbreviations, see the parameter description →  34

## 8.2.2 IO-Link-specific device data

Designation	ISDU (dec)	ISDU (hex)	Size (byte)	Data type	Access	Default value	Data storage
Serial number	21	0x0015	max. 16	String	ro		
Firmware version	23	0x0017	max. 64	String	ro		
ProductID	19	0x0013	max. 64	String	ro	FTW23	
ProductName	18	0x0012	max. 64	String	ro	Liquipoint	
ProductText	20	0x0014	max. 64	String	ro	Capacitance point level switch	
VendorName	16	0x0010	max. 64	String	ro	Endress+Hauser	
VendorText	17	0x0011	max. 64	String	ro	People for Process Automation	
Hardware Revision	22	0x0016	max. 64	String	ro		
Application Specific Tag	24	0x0018	32	String	r/w		
Device Type	256	0x0100	2	UInteger16	ro	0x91FF	
Actual Diagnostics (STA)	260	0x0104	4	String	ro		No
Last Diagnostic (LST)	261	0x0105	4	String	ro		No

## 8.2.3 System commands

Designation	ISDU (dec)	ISDU (hex)	Value range	Access
Reset to factory settings (RES)	2	0x0002	130	w
Device Access Locks.Data Storage Lock	12	0x000C	0 ~ False 2 ~ True	rw

## 8.3 Overview of diagnostic events

→  25

# 9 Commissioning

If an existing configuration is changed, measuring operation continues! The new or modified entries are only accepted once the setting has been made.



### WARNING

**Risk of injury and damage to property due to uncontrolled activation of processes!**

► Make sure that downstream processes are not started unintentionally.

## 9.1 Function check

Before commissioning your measuring point, ensure that the post-installation and post-connection checks have been performed:

- "Post-installation check" checklist →  11
- "Post-connection check" checklist →  13

## 9.2 Commissioning with an operating menu

### IO-Link communication

- Commissioning with factory settings: The device is configured for use with aqueous media. The device can be commissioned directly when used with aqueous media. Factory setting: output 1 and output 2 are configured for XOR operation. The Standard option is selected in the **Active switchpoints** parameter.
  - Commissioning with customer-specific settings, e.g. non-conductive media (oils, alcohols) or powdered products: the device can be configured differently from the factory setting via IO-Link. Select User in the **Active switchpoints** parameter.
-  Each change must be confirmed with Enter to ensure that the value is accepted.
- Incorrect switching is suppressed by adjusting the settings in the switch/switchback delay (Switch point value/Switchback point value parameters).

## 9.3 Hysteresis function, level detection

### 9.3.1 Wet calibration

1. Navigate to the Application menu level
  - ↳ Setting: **Active switchpoints = User**
2. Immerse the device in the medium to be detected.
3. Accept the measured value shown for the switch output in question.
  - ↳ Setting: **Calibrate coverage, Output 1/2 (OU1/2)**  
The automatically generated switch limits can be adjusted accordingly.

### 9.3.2 Dry calibration

This calibration is suitable if the medium values are known.

1. Navigate to the Application menu level
  - ↳ Setting: **Active switchpoints = User**
2. Configure the behavior of the switch output.
  - ↳ Setting: **Output 1/2 (OU1/2) = Hysteresis normally open (MIN) (HNO) or Hysteresis normally closed (MAX) (HNC)**
3. Enter the measured values for the switch point and switchback point. The set value for the switch point "SP1"/"SP2" must be greater than the switchback point "rP1" /"rP2" →  32.
  - ↳ Setting: **Switch point value (Coverage), Output 1/2 (SP1/2 or FH1/2) and Switchback point value (Coverage), Output 1/2 (rP1/2 or FL1/2)**

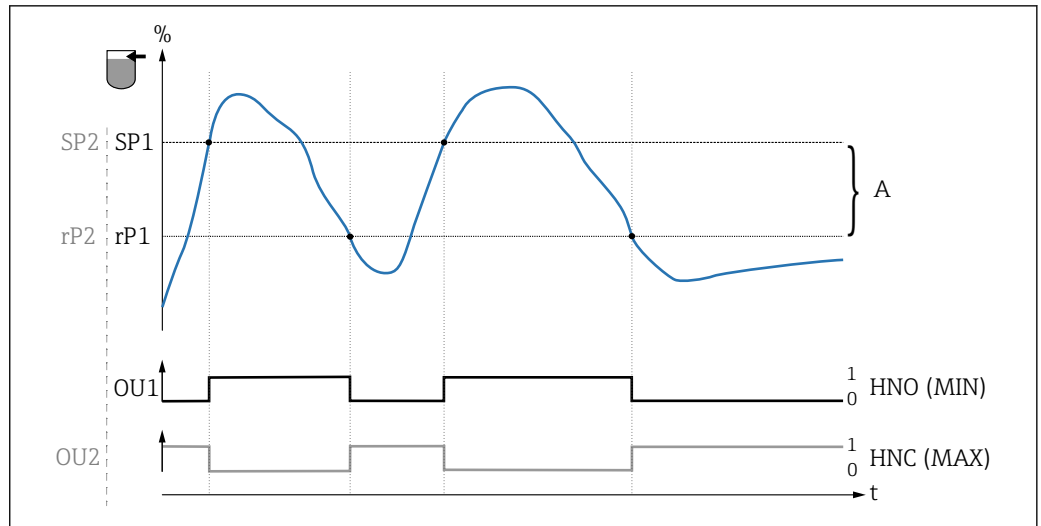

3 Calibration (default)

0 0-signal, output open

1 1-signal, output closed

A Hysteresis (difference between the value of the switch point "SP1" and the value of the switchback point "rP1")

% Coverage of sensor

HNO Normally open contact (MIN)

HNC Normally closed contact (MAX)

SP1 Switch point 1 / SP2: Switch point 2

rP1 Switchback point 1 / rP2: Switchback point 2

**i** Recommended assignment of switch outputs:

- MAX mode for overflow protection (HNC)
- MIN mode for dry running protection (HNO)

## 9.4 Window function, media detection/differentiation

Unlike the hysteresis, media are detected only if they are within the defined window. Depending on the medium, a switch output can be used here.

### 9.4.1 Wet calibration

1. Navigate to the Application menu level
  - ↳ Setting: **Active switchpoints = User**
2. Configure the behavior of the switch output.
  - ↳ Setting: **Output 1/2 (OU1/2) = Window normally open (FNO) or Window normally closed (FNC)**
3. Immerse the device in the medium to be detected.
  - ↳ Setting: **Calibrate coverage, Output 1/2 (OU1/2)**  
 Setting: **Switch point value (Coverage), Output 1/2 (FH1/2) and Switchback point value (Coverage), Output 1/2 (FL1/2)**  
 The automatically generated switch limits can be adjusted accordingly.

### 9.4.2 Dry calibration

This calibration is suitable if the measured values of the medium are known.

**i** For reliable detection of the medium, the process window must be sufficiently large.

1. Navigate to the Application menu level
  - ↳ Setting: **Active switchpoints = User**

2. Configure the behavior of the switch output.
  - ↳ Setting: **Output 1/2 (OU1/2) = Window normally open (FNO) or Window normally closed (FNC)**
3. Define the window around the calibrated value for the switch point/switchback point of the output (percentage coverage). The set value for the switch point "FH1"/"FH2" must be greater than the switchback point "FL1" /"FL2".
  - ↳ Setting: **Switch point value (Coverage), Output 1/2 (SP1/2 or FH1/2) and Switchback point value (Coverage), Output 1 (rP1/2 or FL1/2)**

## 9.5 Application example

Differentiating between milk and cleaning agent (CIP cleaning) using the example of wet calibration in the process.

1. Navigate to the Application menu level
  - ↳ Setting: **Active switchpoints = User**
2. Assign switch function to the switch outputs:
  - ↳ Switch output active if medium detected → Setting: **Output 1 (OU1) = Window normally open (FNO)**
  - ↳ Switch output active if medium detected → Setting: **Output 2 (OU2) = Window normally closed (FNC)**
3. Medium 1: Sensor is covered by milk.
  - ↳ Setting: **Calibrate coverage, Output 1 (OU1)**
4. Medium 2: Sensor is covered by CIP cleaning agent.
  - ↳ Setting: **Calibrate coverage, Output 2 (OU2)**

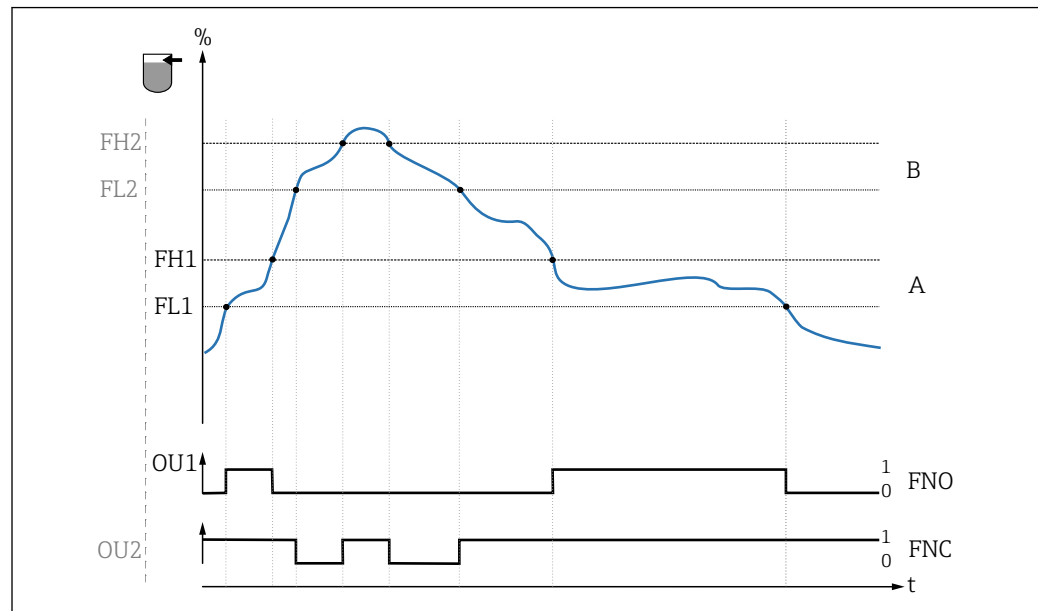

4 Medium detection/Process window

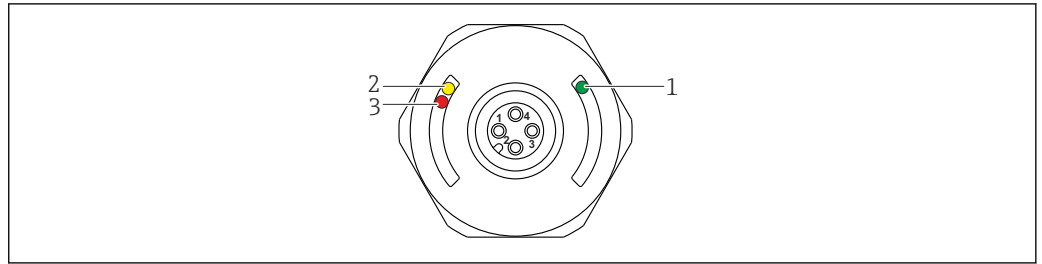

0 0-signal, output open  
 1 1-signal, output closed  
 % Coverage of sensor  
 A Medium 1, process window 1  
 B Medium 2, process window 2  
 FNO Closing  
 FNC NC contact  
 FH1 / FH2 Upper value process window  
 FL1 / FL2 Lower value process window

## 9.6 Light signals (LEDs)



A0022024

5 Position of LEDs in housing cover











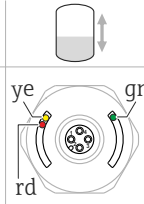

Position	LEDs	Description of function
1	Green LED (gn)	<b>Measuring device is operational</b> lit: SIO mode flashing: active communication, flash frequency  flashes with increased luminosity: device search (device identification), flash frequency 
2	Yellow LED (ye)	<b>Indicates the sensor status</b> lit: Sensor is covered by liquid.
3	Red LED (rd)	<b>Warning/Maintenance required</b> flashing: error remediable, e. g. invalid calibration <b>Fault/device failure</b> lit: error not remediable, e. g. Electronics error Diagnostics and troubleshooting → 23

**i** On the metal housing cover (IP69<sup>1)</sup>) there is no external signaling via LEDs. A connecting cable with M12 connector and LED display can be ordered as an accessory → 37. The functions of the green and red LEDs as described cannot be replicated on the M12 connector with LED.

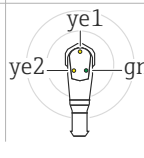
## 9.7 Function of LEDs

**i** Any configuration of the switch outputs is possible. The following table shows the behavior of the LEDs in the SIO mode:

1) The IP69K protection class is defined in accordance with DIN 40050 Part 9. This standard was withdrawn on November 1, 2012 and replaced by DIN EN 60529. As a result, the name of the IP protection class has changed to IP69.

Operating modes	MAX		MIN		Warning	Problem
	Sensor	free	covered	free		
 <p>1</p>						
 <p>2</p>						
1: LEDs on housing cover 2: LEDs on M12 connector LED colors: gn = green, ye = yellow, rd = red			<b>Symbols/Description</b> ● not lit ☀ lit ⚡ flashing ⚡ Fault/warning — no signaling			

## 9.8 Function testing of switch output

Carry out a function test while the device is in operation.

- ▶ Hold the test magnet against the marking on the housing for at least 2 seconds.
  - ↳ This inverts the current switch status, and the yellow LED changes state. When the magnet is removed, the switching status valid at that time is adopted.

If the test magnet is held against the marking for longer than 30 seconds, the red LED will flash: The device returns automatically to the current switch status.

**i** The test magnet is not included in the scope of delivery. It can be ordered as an optional accessory →  37.

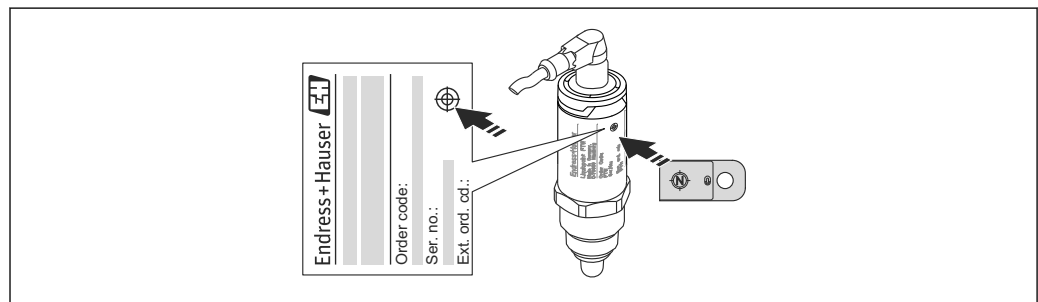

 6 Position for test magnet on housing

A0024417

## 10 Diagnostics and troubleshooting

### 10.1 Troubleshooting

If an electronic/sensor defect is present, the device changes to the failsafe mode and displays the diagnostic event F270. The status of the process data is rendered invalid. The switch output(s) is opened.

#### General errors

Problem	Possible cause	Solution
Device does not respond	Supply voltage does not match the value indicated on the nameplate.	Apply correct voltage.
	The polarity of the supply voltage is wrong.	Correct the polarity.
	Connecting cables are not in contact with the terminals.	Check for electrical contact between cables and correct.
No communication	<ul style="list-style-type: none"> <li>▪ Communication cable not connected.</li> <li>▪ Communication cable incorrectly attached to device.</li> <li>▪ Communication cable incorrectly attached to the IO-Link master.</li> </ul>	Check wiring and cables.
No transmission of process data	There is an error in the device.	Correct errors that are displayed as a diagnostic event → 25.

### 10.2 Diagnostic information via LED display

#### LED display on housing cover

Malfunction	Possible cause	Measure
Green LED not lit	No power supply	Check connector, cable and power supply.
Red LED Flashing	Overload or short-circuit in load circuit	<ul style="list-style-type: none"> <li>▪ Rectify short-circuit.</li> <li>▪ Reduce maximum load current to below 200 mA if one switch output is active.</li> <li>▪ Maximum load current = 105 mA per output if both switch outputs are active.</li> </ul>
	Ambient temperature outside of specification	Operate measuring device in specified temperature range.
	Test magnet held against marking for too long	Repeat function test.
Red LED lit	Internal sensor error	Replace device.

#### LED display on M12 connector, can be ordered as an accessory

Malfunction	Possible cause	Measure
Green LED not lit	No power supply	Check connector, cable and power supply.

## 10.3 Diagnostic events

### 10.3.1 Diagnostic message

Faults that are detected by the device's self-monitoring system are displayed as a diagnostic message via IO-Link.

#### Status signals

The table →  25 lists the messages that may occur. The Actual Diagnostic (STA) parameter displays the message with the highest priority. The device has four different status information codes according to NAMUR NE107:



<b>F</b> A0013956	<b>"Failure"</b> A device error has occurred. The measured value is no longer valid.
<b>M</b> A0013957	<b>"Maintenance required"</b> Maintenance is required. The measured value remains valid.
<b>C</b> A0013959	<b>"Function check"</b> The device is in the service mode (e. g. during a simulation).
<b>S</b> A0013958	<b>"Out of specification"</b> The device is operated: <ul style="list-style-type: none"> <li>▪ Outside its technical specifications (e. g. during warmup or cleaning process)</li> <li>▪ Outside the parameter configuration undertaken by the user (e. g. level outside of configured span)</li> </ul>

#### Diagnostic event and event text

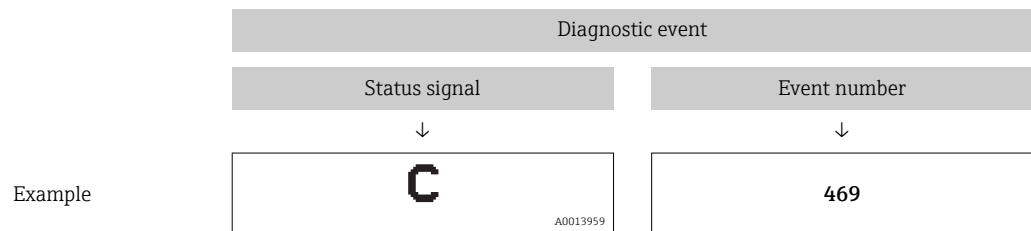
The fault can be identified by means of the diagnostic event.



If two or more diagnostic events are pending simultaneously, only the diagnostic message with the highest priority is shown.

 The last diagnostic message is displayed - see Last Diagnostic (LST) in the **Diagnosis** submenu →  29.



### 10.3.2 Overview of diagnostic events

Status signal/ Diagnostic event	Diagnostic behavior	EventCode	Event text	Cause	Corrective measure
F270	Problem	0x5000	Defect in electronics/ sensor	Electronics/sensor defective	Replace device
S804	Warning	0x1801	Load current > 200 mA per output	Load current > 200 mA	Increase load resistance at switch output
			Overload at switch output 2	Overload at switch output 2	<ul style="list-style-type: none"> <li>▪ Check output circuit</li> <li>▪ Replace device</li> </ul>
C485	Warning	0x8C01 <sup>1)</sup>	Simulation active	When the simulation of a switch output is active, the device displays a warning.	Switch off simulation.
C182	Message	0x1807 <sup>1)</sup>	Invalid calibration	Switch point/switchback point are too close together or interchanged.	<ul style="list-style-type: none"> <li>▪ Check probe coverage</li> <li>▪ Perform configuration again.</li> </ul>
C103	Message	0x1813	Sensor check failed	Sensor check failed	<ul style="list-style-type: none"> <li>▪ Repeat cleaning</li> <li>▪ Replace device</li> </ul>
-	Message	0x1814	Sensor check passed	Sensor check	-
-	Information	0x1815	Timeout Reedcontact	Timeout reed contact	Remove text magnet
S825	Warning	0x1812	Ambient temperature outside of specification	Ambient temperature outside of specification	Operate device in the specified temperature range

1) EventCode as per IO-Link standard 1.1

### 10.4 Behavior of the device in the event of a fault

The device displays warnings and faults via I/O-Link. All the device warnings and faults are for information purposes only and do not have a safety function. The errors diagnosed by the device are displayed via IO-Link in accordance with NE107. In accordance with the diagnostic message, the device behaves as per a warning or fault condition. It is necessary to distinguish between the following types of errors here:

- **Warning:**
  - The device continues measuring if this type of error occurs. The output signal is not affected (exception: simulation is active).
  - The switch output remains in the state defined by the switch points.
- **Fault:**
  - The device does **not** continue measuring if this type of error occurs. The output signal assumes its fault state (switch outputs de-energized).
  - The fault state is displayed via IO-Link.
  - The switch output changes to the "open" state.

### 10.5 Resetting to factory settings (reset)

See Reset to factory settings (RES) parameter description →  36.

## 11 Maintenance

No special maintenance work is required.

### 11.1 Cleaning

The sensor must be cleaned if necessary. Cleaning can also be done while it is installed (e.g. CIP Cleaning in Place / SIP Sterilization in Place). Care must be taken to ensure that no damage occurs to the sensor in the process.

## 12 Repairs

Repair is not envisaged for this measuring device.

### 12.1 Return

The measuring device must be returned if the wrong device has been ordered or delivered. As an ISO-certified company and also due to legal regulations, Endress+Hauser is obliged to follow certain procedures when handling any returned products that have been in contact with medium. To ensure safe, swift and professional device returns, please refer to the procedure and conditions for returning devices provided on the Endress+Hauser website at <http://www.endress.com/support/return-material>

### 12.2 Disposal

When disposing, separate and recycle the device components based on the materials.

## 13 Overview of the onsite display operating menu

### Navigation

IO-Link	Level 1	Level 2	Details	
Identification	Extended Ordercode		→  28	
	ENP_VERSION		→  28	
	Application Specific Tag		→  28	
Diagnosis	Actual Diagnostics		→  29	
	Last Diagnostic		→  29	
	Simulation Switch Output		→  29	
	Simulation Switch Output		→  29	
	Device search		→  30	
	Sensor check		→  30	
Parameter	Application	Active switchpoints	→  31	
		Reset user switchpoints	→  31	
		Calibrate coverage, Output 1	→  31	
		Switch point value (Coverage), Output 1	→  32	
		Switchback point value (Coverage), Output 1	→  32	
		Switching delay time, Output 1	→  33	
		Switchback delay time, Output 1	→  33	
		Output 1	→  34	
		Calibrate coverage, Output 2	→  31	
		Switch point value (Coverage), Output 2	→  32	
		Switchback point value (Coverage), Output 2	→  32	
		Switching delay time, Output 2	→  33	
		Switchback delay time, Output 2	→  33	
	Output 2	→  34		
	System	Operating hours		→  35
		µC temperature		→  35
		Unit changeover - µC-Temperature		→  35
		Minimum µC-Temperature		→  36
		Maximum µC-Temperature		→  36
		Reset to factory settings		→  36
Device Access Locks.Data Storage Lock			→  36	
Observation	Coverage		→  37	
	Switch State Output 1		→  37	
	Switch State Output 2		→  37	

## 14 Description of Device Parameters

### 14.1 Identification

---

#### Extended ordercode

---

<b>Navigation</b>	Identification → Extended ordercode
<b>Description</b>	Used to replace the device. Displays the extended order code (max. 60 alphanumeric characters).
<b>Factory setting</b>	As per order specifications

---

#### ENP\_VERSION

---

<b>Navigation</b>	Identification → ENP_VERSION
<b>Description</b>	Displays the ENP version (ENP: electronic name plate)

---

#### Application Specific Tag

---

<b>Navigation</b>	Identification → Application Specific Tag
<b>Description</b>	Used for unique identification of device in the field. Enter device tag (max. 32 alphanumeric characters).
<b>Factory setting</b>	As per order specifications

## 14.2 Diagnosis

---

### Actual Diagnostics (STA)

---

**Navigation**                      Diagnosis → Actual Diagnostics (STA)

**Description**                      Displays the current device status.

---

### Last Diagnostic (LST)

---

**Navigation**                      Diagnosis → Last Diagnostic (LST)

**Description**                      Displays the latest device status (error or warning) that was rectified during operation.

---

### Simulation Switch Output (OU1)

---

**Navigation**                      Diagnosis → Simulation Switch Output (OU1)

**Description**                      The simulation affects the process data only. It does not affect the physical switch output. If a simulation is active, a warning to this effect is displayed so that it is obvious to the user that the device is in the simulation mode. A warning is communicated via IO-Link (C485 - simulation active). The simulation must be ended actively via the menu. If the device is disconnected from the power supply during the simulation and power is then resupplied, the simulation mode is not resumed, and instead the device continues operation in the measuring mode.

**Options**                              ■ Off  
    ■ ou1 = high  
    ■ ou1 = low

---

### Simulation Switch Output (OU2)

---

**Navigation**                      Diagnosis → Simulation Switch Output (OU2)



**Description**                      The simulation affects the process data and the physical switch output. If a simulation is active, a warning to this effect is displayed via IO-Link so that it is obvious to the user that the device is in the simulation mode (C485 - simulation active). The simulation must be ended actively via the menu. If the device is disconnected from the power supply during the simulation and power is then resupplied, the simulation mode is not resumed, and instead the device continues operation in the measuring mode.

**Options**                              ■ Off  
    ■ ou2 = high  
    ■ ou2 = low

---

**Device search**

---

<b>Navigation</b>	Diagnostics → Device search
<b>Description</b>	This parameter is used to uniquely identify the device during installation. The green LED is lit (= operational) on the device and starts to flash with increased luminosity, flash frequency  .
<b>Note</b>	On the metal housing cover (IP69), there is no external signaling via LEDs→  21.
<b>Options</b>	<ul style="list-style-type: none"><li>▪ Off</li><li>▪ On</li></ul>
<b>Factory setting</b>	Off

---

**Sensor check**

---

<b>Navigation</b>	Diagnostics → Sensor check
<b>Description</b>	This parameter is used to test if the measuring point is functioning correctly. The sensor must not be covered and must be free of residue. The device compares the current measured values with the measured values from the factory calibration.
<b>Options</b>	Check: Following the test, one of the following messages is displayed: <ul style="list-style-type: none"><li>▪ Message (0x1814) for sensor check passed</li><li>▪ Message C103 (0x1813) for sensor check failed</li></ul>

## 14.3 Parameter

### 14.3.1 Application

---

#### Active switchpoints

---

<b>Navigation</b>	Application → Active switchpoints
<b>Description</b>	Choice between standard or customer-specific, user-definable switch points
<b>Switch-on value</b>	Last setting selected prior to switching off device.
<b>Options</b>	<ul style="list-style-type: none"> <li>■ Standard</li> <li>■ User</li> </ul>
<b>Factory setting</b>	Standard

---

#### Reset user switchpoints

---

<b>Navigation</b>	Application → Reset user switchpoints
<b>Note</b>	This parameter is visible only if the User option is selected in the Active Switchpoint parameter.
<b>Description</b>	After selecting an output, switch point OU1 or OU2, the switch output and its associated value are reset to the factory setting.
<b>Options</b>	<ul style="list-style-type: none"> <li>■ False</li> <li>■ switchpoints OU1</li> <li>■ switchpoints OU2</li> </ul>
<b>Factory setting</b>	False

---

#### Calibrate coverage, Output 1/2 (OU1/OU2)

---

<b>Navigation</b>	Application → Calibrate coverage, Output 1/2 (OU1/OU2)
<b>Description</b>	<p>Wet calibration with covered sensor.  A switching threshold that suits the process is generated with the measuring signal that is present.  Example →  18 ff</p>

## Switch point value (Coverage), Output 1/2 (SP1/SP2) Switchback point value (Coverage), Output 1/2 (rP1/rP2)

### Navigation

Application → Switch point value (Coverage), Output 1/2 (SP1/SP2)

Application → Switchback point value (Coverage), Output 1/2 (rP1/rP2)

### Note

The switching sensitivity of the sensor is set using the SP1/rP1 or SP2/rP2 parameters. Since the parameter settings depend on one another, the parameters are described all together.

- SP1 = switch point 1
- SP2 = switch point 2
- rP1 = switchback point 1
- rP2 = switchback point 2

### Description

The switching sensitivity of the sensor can be configured using the switch point and switchback point. The switch sensitivity can be adapted to the medium (depending on the DC value (dielectric constant) or conductivity of medium).

- Sensor switches if there is slight coverage = very sensitive.
- Sensor switches if there is heavy buildup = not sensitive.

The set value for the switch point SP1/SP2 must be greater than the switchback point rP1/rP2!

A diagnostic message is displayed if a switch point SP1/SP2 is entered that is  $\leq$  switch-back point rP1 /rP2 .

When the set switchback point rP1/rP2 is reached, an electrical signal change takes place again at the switch output (OU1/OU2). The difference between the value of the switch point SP1/SP2 and the value of the switchback point rP1/rP2 is known as the hysteresis.

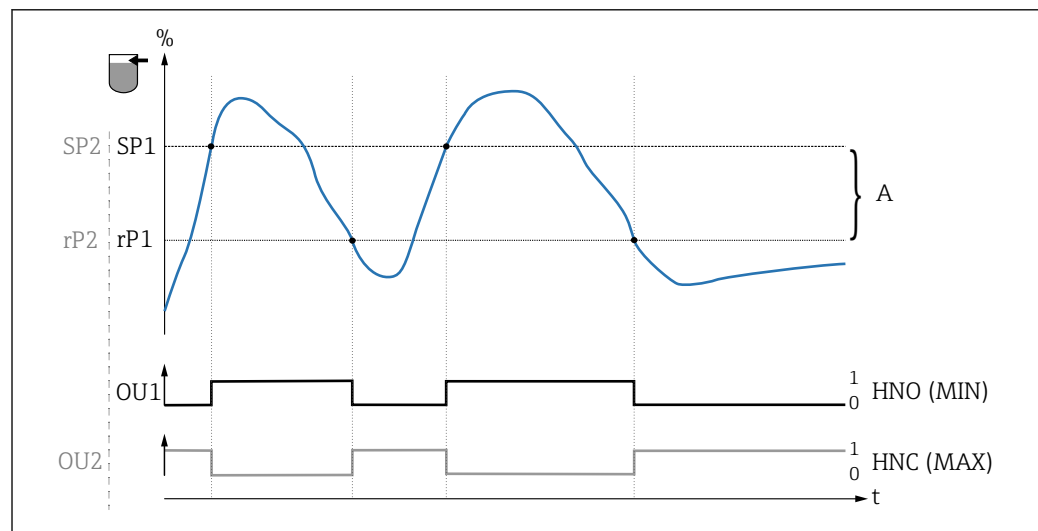

A0034529

#### 7 Calibration (default)

0 0-signal. Output open

1 1-signal. Output closed

A Hysteresis (difference between the value of the switch point SP1/SP2 and the value of the switchback point rP1/rP2)

% Coverage of sensor

HNO Normally open contact (MIN)

HNC Normally closed contact (MAX)

SP1 Switch point 1 / SP2: Switch point 2

rP1 Switchback point 1 / rP2: Switchback point 2



Examples of set values in parameters

Medium	Coverage of sensor (as %)	Sensitivity (SP/rP)
Water	100	70/65
Ethanol	80	55/50
Oil	20	15/10
Honey	60	55/50

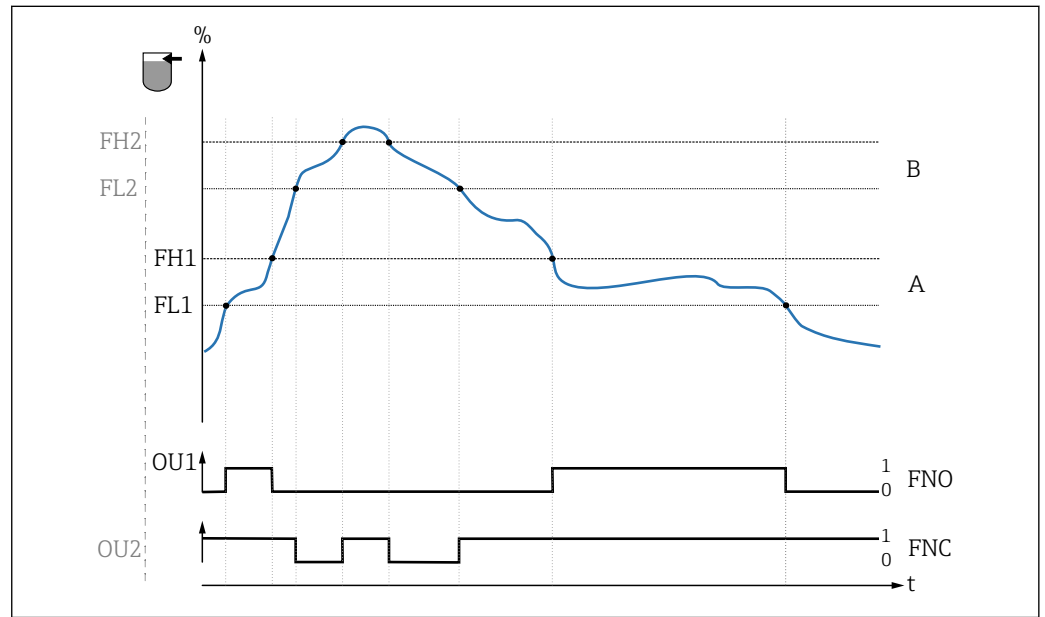

8 Medium detection/Process window

- 0 0-signal. Output open
- 1 1-signal. Output closed
- % Coverage of sensor
- A Medium 1, process window 1
- B Medium 2, process window 2
- FNO Closing
- FNC NC contact 1
- FH1 / FH2 Upper value process window
- FL1 / FL2 Lower value process window

**Note** The various points for the switching delay can be adjusted to ensure that rapid switching back and forth at the switch limits is suppressed.

**Switch-on value** Last value selected prior to switching off.

**Options** No selection. The user is free to edit the values.

**Input range** 0 to 200

**Factory setting** 77.5 % switch point (coverage of sensor), output 1 (SP1)  
73 % switchback point (coverage of sensor), output 1 (rP1)

---

Switching delay time, Output 1/2 (dS1/dS2)  
Switchback delay time, Output 1/2 (dR1/dS2)

---

**Navigation**

Application → Switch output → Switching delay time, Output 1/2 (dS1/dS2)  
 Application → Switch output → Switchback delay time, Output 1/2 (dR1/dR2)

**Note**

The switching delay time/switchback delay time functions are implemented using the "dS1"/"dS2" and "dR1"/"dR2" parameters. Since the parameter settings depend on one another, the parameters are described all together.

- dS1 = switching delay time, output 1
- dS2 = switching delay time, output 2
- dR1 = switchback delay time, output 1
- dR2 = switchback delay time, output 2

**Description**

To prevent rapid switching back and forth when values are close to the switch point "SP1"/"SP2" or switchback point "rP1"/"rP2", a delay in the range of 0.3 to 600 seconds, to one decimal place, can be set for individual points.

If the measured value leaves the switching range during the delay time, the delay time starts again from scratch.

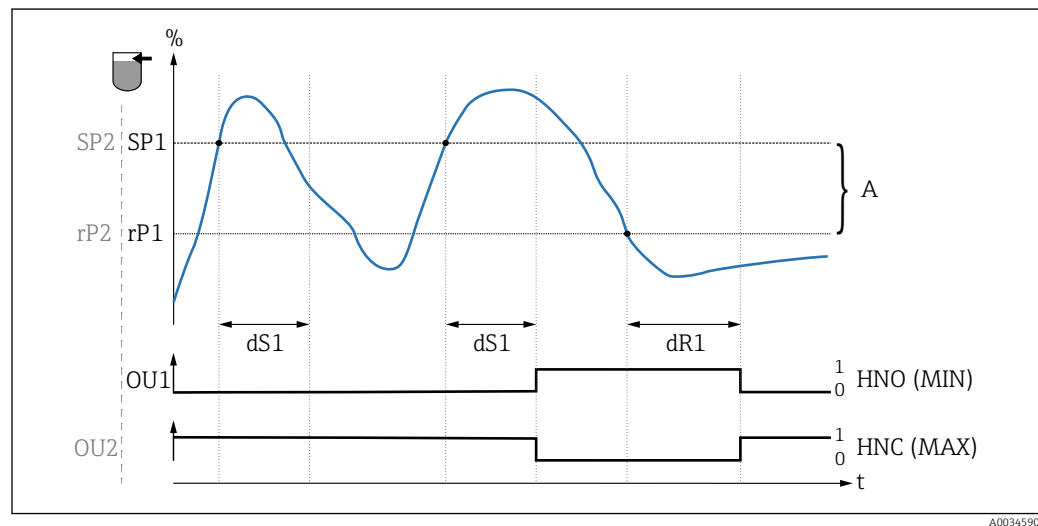

A0034590

0 0-signal, output open in the quiescent state

1 1-signal, output closed in the quiescent state

A Hysteresis (difference between the value of the switch point "SP1" and the value of the switchback point "rP1")

HNO Normally open contact (MIN)

HNC Normally closed contact (MAX)

% Coverage of sensor

SP1 Switch point 1 / SP2: Switch point 2

rP1 Switchback point 1 / rP2: Switchback point 2

dS1 Set time for which the specific switch point must be reached continuously without interruption until an electrical signal change takes place.

dR1 Set time for which the specific switchback point must be reached continuously without interruption until an electrical signal change takes place.

**Switch on value**

Last value selected prior to switching off.

**Options**

No selection. The user is free to edit the values.

**Input range**

0.3 to 600

**Factory setting**

0.5 s (Switching delay time dS1/dS2)

1.0 s (Switchback delay time dR1/dR2)

**Output 1/2 (OU1/OU2)**

<b>Navigation</b>	Application → Output 1/2 (OU1/OU2)
<b>Description</b>	<ul style="list-style-type: none"> <li>■ Hysteresis: Determining whether sensor is free or covered.</li> <li>■ Window: Determining medium Setting is medium-specific in each case. <ul style="list-style-type: none"> <li>– SP1/rP1 = medium 1</li> <li>– SP2/rP2 = medium 2</li> </ul> </li> </ul>
<b>Switch on value</b>	Last function selected prior to switching off.
<b>Options</b>	<ul style="list-style-type: none"> <li>■ Hysteresis normally open (MIN)</li> <li>■ Hysteresis normally closed (MAX)</li> <li>■ Window normally open</li> <li>■ Window normally closed</li> </ul>
<b>Factory setting</b>	Output 1 (OU1): HNO Output 2 (OU2): HNC

### 14.3.2 System

---

#### Operating hours

---

<b>Navigation</b>	System → Operating hours
<b>Description</b>	This parameter counts the operating hours in minutes during the period in which operating voltage is present.

---

#### μC-Temperature

---

<b>Navigation</b>	System → μC temperature
<b>Description</b>	This parameter displays the current μC-temperature on the electronics.

---

#### Unit changeover (UNI) - μC-Temperature

---

<b>Navigation</b>	System → Unit changeover (UNI) - μC-Temperature
<b>Description</b>	This parameter is used to select the electronics temperature unit. Once a new electronics temperature unit has been selected, the new unit is calculated and displayed.
<b>Switch on value</b>	Last unit selected prior to switching off.
<b>Options</b>	<ul style="list-style-type: none"> <li>■ °C</li> <li>■ °F</li> <li>■ K</li> </ul>
<b>Factory setting</b>	°C

---

### Minimum $\mu$ C-Temperature

---

<b>Navigation</b>	System → Minimum $\mu$ C temperature
<b>Description</b>	This parameter is used as the minimum peak indicator and makes it possible to call up retroactively the lowest electronics temperature measured. If the value of the peak indicator is overwritten, the value is automatically set to the temperature currently measured.

---

### Maximum $\mu$ C temperature

---

<b>Navigation</b>	System → Maximum $\mu$ C temperature
<b>Description</b>	This parameter is used as the maximum peak indicator and makes it possible to call up retroactively the highest electronics temperature measured. If the value of the peak indicator is overwritten, the value is automatically set to the temperature currently measured.

---

### Reset to factory settings (RES)

---

<b>Navigation</b>	System → Reset to factory settings (RES)
<b>Description</b>	<p><b>⚠ WARNING</b></p> <p><b>Confirming the "Standard Command" with "Reset to factory settings" causes an immediate reset to the factory settings of the order configuration.</b></p> <p>If the factory settings have been changed, downstream processes might be affected following a reset (the behavior of the switch output or current output might be changed).</p> <ul style="list-style-type: none"> <li>▶ Make sure that downstream processes are not started unintentionally.</li> </ul> <p>The reset is not subject to additional locking, such as in the form of device locking. The reset also depends on the device status. Any customer-specific configuration carried out at the factory is not affected by a reset (customer-specific configuration remains).</p> <p>The following parameters are <b>not</b> reset when a reset is performed:</p> <ul style="list-style-type: none"> <li>■ Minimum <math>\mu</math>C-Temperature</li> <li>■ Maximum <math>\mu</math>C-Temperature</li> <li>■ Last Diagnostic (LST)</li> <li>■ Operating hours</li> </ul>
<b>Note</b>	The last error is not reset in a reset.

---

### Device Access Locks.Data Storage Lock

---

<b>Navigation</b>	System → Device Access Locks.Data Storage Lock
-------------------	--

**Description**

The device supports DataStorage. If a device is being replaced, this allows the configuration of the old device to be written to the new device. If, when a device is being replaced, the original configuration of the new device is to be retained, the **Device Access Locks.Data Storage Lock** parameter can be used to prevent the parameters from being overwritten. If this parameter is set to "true", the new device does not adopt the data stored in the master's DataStorage.

**Options**

- false
- true

### 14.4 Observation

The process data →  15 are transmitted acyclically.

## 15 Accessories

Description	Order number
Test magnet	71267011
Socket wrench, hex bolt, 32 AF	52010156
Process adapter M24x1.5, weld-in adapter, slotted nut and seals	see TI00426F/00/EN

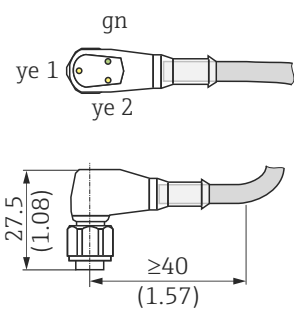
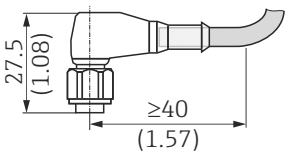
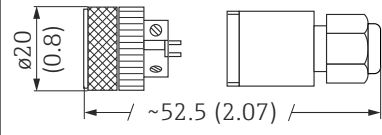
Description	Order number	
Cable, plug-in jack Engineering unit mm (in) 	<b>M12 IP69 with LED</b> <ul style="list-style-type: none"> <li>▪ elbowed 90°, terminated at one end</li> <li>▪ 5 m (16 ft) PVC cable (orange)</li> <li>▪ Body: PVC (transparent)</li> <li>▪ Slotted nut 316L</li> </ul>	52018763
	<b>M12 IP69 without LED</b> <ul style="list-style-type: none"> <li>▪ elbowed 90°, terminated at one end</li> <li>▪ 5 m (16 ft) PVC cable (orange)</li> <li>▪ Body: PVC (orange)</li> <li>▪ Slotted nut 316L (1.4435)</li> </ul>	52024216
Example: M12 with LED	<b>M12 IP67 without LED</b> <ul style="list-style-type: none"> <li>▪ elbowed 90°</li> <li>▪ 5 m (16 ft)PVC cable (gray)</li> <li>▪ Slotted nut Cu Sn/Ni</li> <li>▪ Body: PUR (blue)</li> </ul>	52010285
	<b>M12 IP67 without LED</b> <ul style="list-style-type: none"> <li>▪ straight, self-terminated connection to M12 connector</li> <li>▪ Slotted nut Cu Sn/Ni</li> <li>▪ Body: PBT</li> </ul>	52006263
<b>Wire colors for M12 connector:</b> 1 = BN (brown), 2 = WT (white), 3 = BU (blue), 4 = BK (black)		

Detailed information on accessories can be found in the technical documentation TI01202F/00/EN.

# Index

## Symbols

$\mu$ C-Temperature . . . . . 35

## A

Active switchpoints . . . . . 31

Actual Diagnostics (STA) . . . . . 29

Application . . . . . 31

Application Specific Tag . . . . . 28

## C

Calibrate coverage, Output 1/2 (OU1/OU2) . . . . . 31

## D

Device Access Locks.Data Storage Lock . . . . . 36

Device search . . . . . 30

Diagnosis . . . . . 29

Diagnostic event . . . . . 24

Diagnostic events . . . . . 24

Diagnostic message . . . . . 24

Diagnostics

    Symbols . . . . . 24

## E

ENP\_VERSION . . . . . 28

Event text . . . . . 24

Extended ordercode . . . . . 28

## H

Hysteresis function . . . . . 18

## I

Identifying the measuring device . . . . . 8

In alarm condition . . . . . 24

Incoming acceptance . . . . . 8

Inspection . . . . . 8

## L

Last Diagnostic (LST) . . . . . 29

## M

Maximum  $\mu$ C-Temperature . . . . . 36

Menu

    Description of device parameters . . . . . 28

    Overview . . . . . 27

Minimum  $\mu$ C-Temperature . . . . . 36

## N

Nameplate . . . . . 9

## O

Operating hours . . . . . 35

Operating menu

    Description of device parameters . . . . . 28

    Overview . . . . . 27

Operating modes . . . . . 12

Output 1/2 (OU1/OU2) . . . . . 34

## P

Parameter . . . . . 31

Post-connection check . . . . . 13

## R

Reset to factory settings (RES) . . . . . 36

Reset user switchpoints . . . . . 31

Return . . . . . 26

## S

Sensor check . . . . . 30

Simulation Switch Output (OU1) . . . . . 29

Simulation Switch Output (OU2) . . . . . 29

Status signals . . . . . 24

Switch point value (Coverage), Output 1/2 (SP1/SP2) 32

Switchback delay time, Output 1/2 (dR1/dS2) . . . . . 33

Switchback point value (Coverage), Output 1/2 (rP1/

rRP2) . . . . . 32

Switching delay time, Output 1/2 (dS1/dS2) . . . . . 33

System . . . . . 35

## T

Troubleshooting . . . . . 23

## U

Unit changeover (UNI) -  $\mu$ C-Temperature . . . . . 35

## W

W@M Device Viewer . . . . . 8

Window function . . . . . 19





[www.addresses.endress.com](http://www.addresses.endress.com)

---