

# TROUBLESHOOTING

---



# CHAPTER 8

## In This Chapter...

Common Problems .....	.8-2
Toubleshooting Flow Chart .....	.8-3
Touch Panel does not Power up .....	.8-4
Display is Blank .....	.8-5
Display is Dim .....	.8-6
No User Program .....	.8-7
No Communications between Panel and PC (Personal Computer) .....	.8-8
No Communications between Panel and PLC .....	.8-13
IP Address in System Setup Screens displays 0.0.0.0 .....	.8-16
Difficulty Connecting to the Panel over the Internet (Web server and Remote Access features) .....	.8-17
PLC Protocol Error Codes .....	.8-18
Touch Panel Runtime Errors .....	.8-19
Panel Constantly Displays "Initializing" when Powering up .....	.8-20
Data not Logging Problems .....	.8-20
Loss of Date/Time and Retentive Data .....	.8-21
Electrical Noise Problems .....	.8-21



The following topics are some of the more likely problems that may be encountered during the installation and operation of your *C-more* touch panel. We have made some suggestions on what to check in order to correct the problem. Please start with the troubleshooting flow chart that covers the more common problems encountered by other users.

### Common Problems

The troubleshooting flow chart shown on the following page is based on the more common problems fielded by our technical support team. If you are having problems, please start with the flow chart, follow the suggestions listed, and if you still need help, call our tech support team @ 770-844-4200. In addition to having ready the information suggested in the flow chart, please have the following available:

- 1) *C-more* touch panel part number including serial number with date code. See page 1-5 in this hardware user manual for an explanation of the part number, serial number, and date code breakdown. Why is this information important? The various sizes of the touch panel use different processors and memory sizes, and therefore can have different types of problems within the particular panel size.
- 2) Programming software version that you are currently using. For example: Version 2.20 (Please note that software versions 2.0.7.35 and before will also have a build number such as 2.0 Build 07.35). Having the software version number will allow our tech support team member to assess whether there are similar problems that have been reported when using the same version of the software. The programming software version can be found by clicking on “About *C-more* Programming Software...” selection under the **Help** pull down menu in the software. Also, it is always a good practice to visit the **Software/Firmware Downloads** area under the Tech Support section of the *AutomationDirect* website and check to see if you are using the latest version of the programming software. If you aren't using the latest software version, we suggest that you upgrade to see if this resolves your problem.



---

**Note:** The “About *C-more* Programming Software...” dialog box will show a Firmware version on the newer releases of the programming software. This is the current firmware version that is included with the programming software and does not reflect what firmware is actually loaded on your *C-more* touch panel. See the following for details on how to check the firmware version.

---

- 3) Firmware version of the *C-more* touch panel. For example: 2.0 Build 07.32 or 2.0.07.32. The firmware version can be checked by using the **System Setup Screens**, going to the **Information** menu under the **Main Menu**, and looking under the **General** tab for **Firmware:-Runtime**. The firmware version can also be checked by using the programming software, while connected to the panel, and clicking on the **Panel Information** selection under the **Panel** pull down menu. As with the programming software version, it is important for our tech support associates to know which firmware version you are using so they can check on any known problems. As with the programming software, we strongly suggest that the firmware be updated to the latest version. Check for the latest version and download from the **Software/Firmware Downloads** area of the *AutomationDirect* website.

It is also helpful to have a copy of your project file for our tech support associates to use in troubleshooting a problem, so please be prepared to forward a copy of your project if it is requested.

Troubleshooting Flow Chart

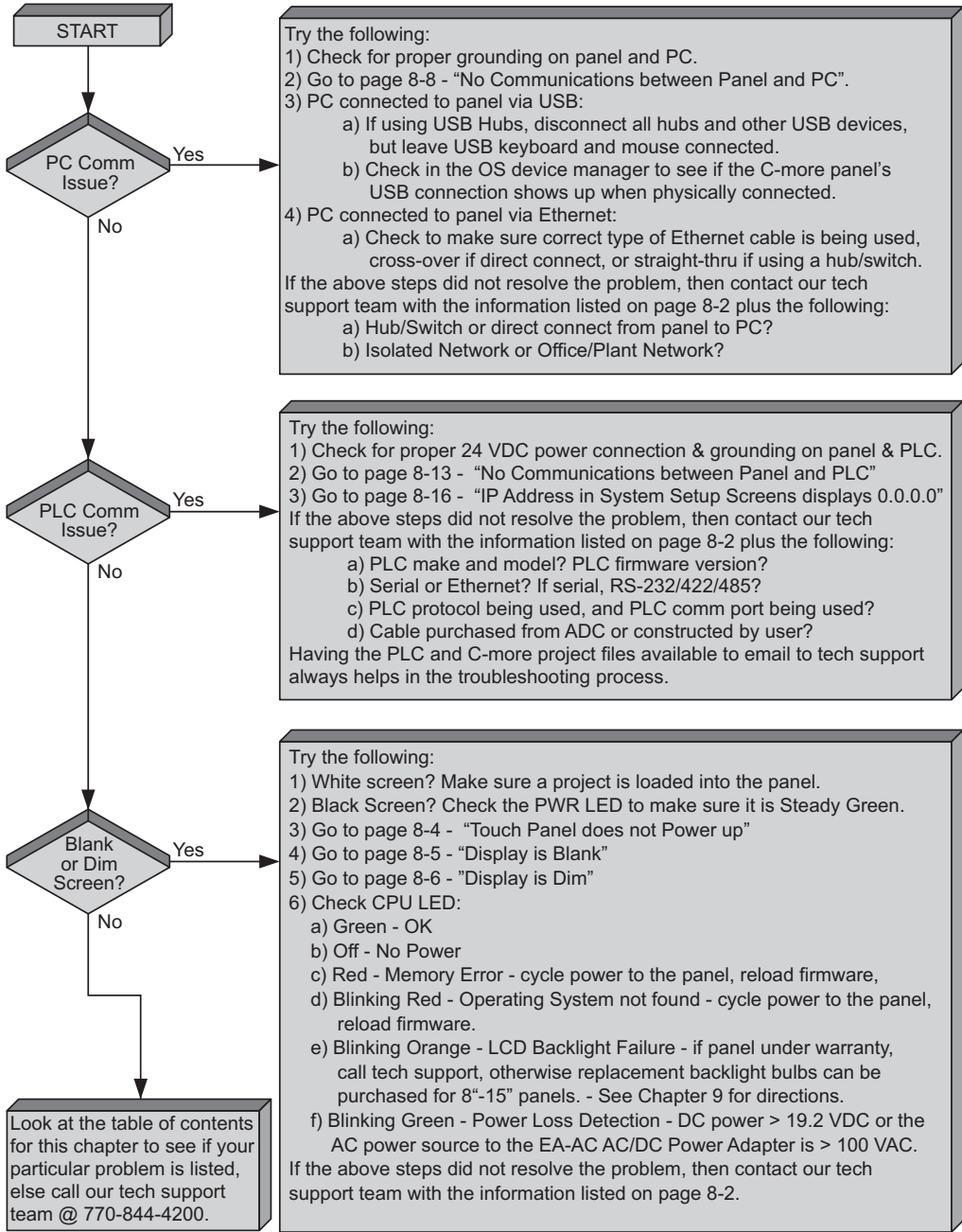

### Touch Panel does not Power up

- 1.) Check the status indicators on the rear of the panel to see if the **Power LED (Green)** indicator is on. Reference the diagram shown below. If the **Power LED (Green)** indicator is on and the panel was observed showing “Initializing...” during power up, but the display is now blank, go to the next troubleshooting tip, **Display is Blank**.
- 2.) If the **Power LED (Green)** indicator is off and the panel is being powered with a 24 VDC power source, use a voltmeter to check the incoming DC voltage level. The DC voltage level should be in the range of 20.4 to 28.8 VDC. If the incoming DC voltage is zero, check any fusing that may be in the circuit. If the fuse is open, determine cause and replace. If the DC voltage level is out of range, the DC power source needs to be corrected or replaced.
- 3.) If the **Power LED (Green)** indicator is off and the panel is being powered with an AC/DC Power Adapter, EA-AC, use a voltmeter to check the incoming AC power. The AC voltage to the AC/DC Power Adapter should be in the range of 100 to 240 VAC, 50/60 Hertz. If the incoming AC voltage is zero, check any fusing that may be in the circuit. If the fuse is open, determine cause and replace. If proper AC voltage is present on the AC/DC Power Adapter, but the **Power LED (Green)** indicator is off, replace the AC/DC Power Adapter, EA-AC.

8

### C-more LED Status Indicators

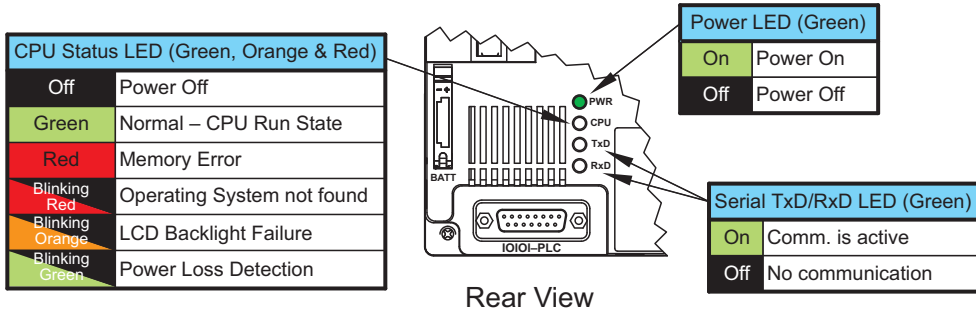

## Display is Blank

- 1.) Touch the screen to make sure the panel is not in the **Screen Saver** mode.
- 2.) If the panel is not in **Screen Saver** mode, check the status indicators on the rear of the panel.

**C-more LED Status Indicators**

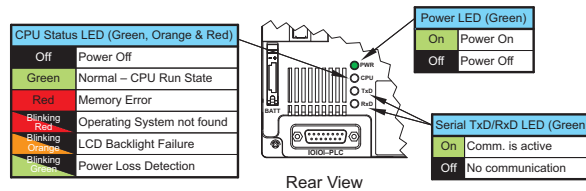

- The **Power LED (Green)** should be on. If not, check the incoming power as explained in the “Touch Panel does not Power Up” section.
  - Make sure the CPU status LED (**Green, Orange, Red**) is a **steady Green**.
  - A **blinking Orange** colored CPU status LED indicates a failed LCD display backlight. The backlights are user replaceable on the 8”, 10”, 12” and 15” C-more touch panels. See **Chapter 9: Replacement Parts** for additional information on the replacement backlights.
  - If the CPU status LED is **blinking Green**, then the supply voltage is below 19.2 VDC, or below 100 VAC when using the optional *C-more* AC/DC Power Adapter, EA-AC. The backlight will turn off immediately to extend the power retention period. The panel will continue to run and the LCD display will be slightly visible. This may be seen as the display being dim, so it is advisable to check the incoming voltage. The panel does not turn off until the DC voltage drops below 5 VDC or below 58 VAC when using the AC/DC Power Adapter, EA-AC.
  - A **blinking Red** CPU status LED indicates that the operating system could not be found. Reload the firmware to the touch panel. If this does not resolve the problem, contact the *AutomationDirect* returns department @ 1-800-633-0405 to make arrangements for returning the unit for repair.
- 3.) There is always the remote possibility that a project has been transferred to the touch panel that includes a screen that uses a black background and has no objects placed on the screen. To check for this possibility, access the **Main Menu** of the touch panel **System Setup Screens** by pressing the extreme upper left corner of the panel display area for three (3) seconds as shown below. If the **System Setup Screen’s Main Menu** is displayed, then most likely an empty black background screen is being displayed.

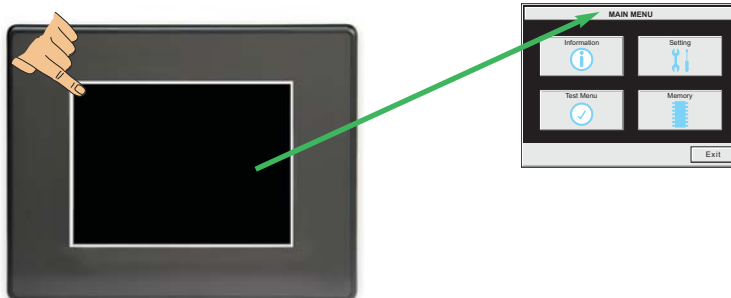

### Display is Dim

- 1.) Check either the contrast or brightness setting found under the System Setup Screens. Keep in mind that the STN type display models can have the contrast adjusted. The TFT type display models can have the brightness adjusted. See **Chapter 5: System Setup Screens** for additional information.

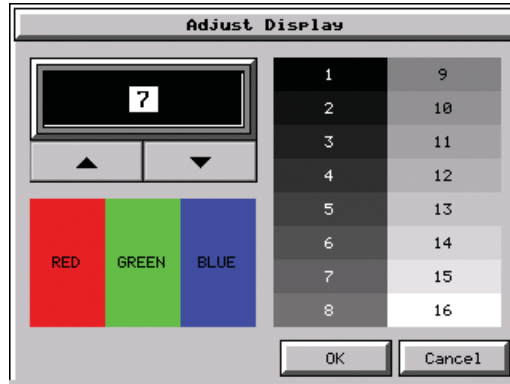

- 2.) Backlights will slowly lose some luminance causing the display to slightly dim. The backlight average lifetime is rated at 50,000 hours and is defined as the average usage time it takes before the brightness becomes 50% of the initial brightness. The lifetime of the backlight depends on the ambient temperature; the lifetime decreases in low or high temperatures. To improve the backlight life, use the **Start Screen Saver** function that is available in the *C-more* Programming Software in the Panel Manager dialog box. The backlights are user replaceable on the 8", 10", 12" and 15" *C-more* touch panels. See **Chapter 9: Replacement Parts** for additional information on the replacement backlights.
- 3.) Another condition that may make the display appear dim is to view the touch panel in direct sunlight or in a location where direct light is reflected onto the display. The *C-more* touch panel displays have **Display Brightness** ratings of 150 to 300 cd/m<sup>2</sup> (NITS), depending on the particular model. The higher the cd/m<sup>2</sup> (NITS) rating, the more visible the display will be under bright lighting conditions.

## No User Program

If the touch screen is displaying the message “No User Program” after it has powered up, then either:

- the built-in Flash memory does not contain a recognized project, or
- a CompactFlash memory card is plugged into the CF1 slot and there is no project on the CompactFlash memory card. Turn the power off, remove the CompactFlash memory card and turn the power back on.

Keep in mind that on power up, the touch panel will either copy the project from its internal Flash memory to its internal SDRAM memory and run the project, or if a CompactFlash memory card is plugged into the CF1 slot, then any project contained on the CF memory card will be copied to the panel’s internal SDRAM memory and be run. In other words, the memory of a CompactFlash card on CF1 will override the panel’s internal Flash memory on power up or reboot, even if the CompactFlash memory card does not contain a project.



## No Communications between Panel and PC (Personal Computer)

The *C-more* touch panel is programmed using the *C-more* Programming Software, EA-PGMSW. The developed project is transferred from the PC to the touch panel by either a USB or an Ethernet connection between the two. (Ethernet available on full feature units only.)

- 1.) If using USB, then a USB type AB programming cable, such as p/n USB-CBL-AB15, should be used to make a connection between the panel's USB Port, Type B and a USB port on the PC. The *C-more* Programming Software will install a USB driver on the PC during the software installation.

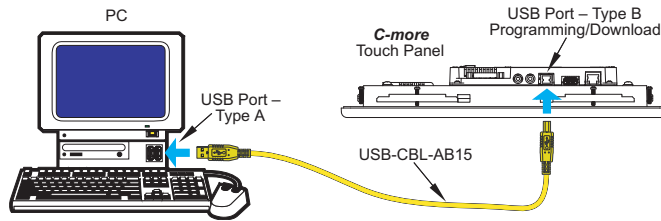

Use the programming software to check the status of the USB communications. From the **Navigation** window, select the **Panel** tab. At the bottom of the **Panel** tab is the **Communication Config** dialog box. If the USB communications to the panel is working, then the USB radio button should be checked and there should be a “green” indicator next to the USB selection. For reference, if the USB driver is working and you open the **Device Manager** in **Windows**, you should see a “**C-more HMI**” USB connection under **Universal Serial Bus controllers** selection. You can also make sure the *C-more* USB driver has been installed by looking for the following file: `C:\WINDOWS\System32\Drivers\kyceusb.sys` If the indicator is “red”, then try using a different cable. If replacing the cable does not fix the communications, you may need to try a different USB port on the PC. If there are any USB hubs or other USB devices being used, you may need to temporarily eliminate them to see if this solves the problem.

**Note:** When transferring a project to the panel using the **Send Project to Panel** function, there is a possibility even with a USB programming cable properly connected between the touch panel and PC, and having a green indicator displayed next to the USB radio button in the **Step 3 - Project Transfer** dialog box, that the **Transfer** button in the dialog box will still be dim. The green indicator means that the very lowest level of USB communications is connected, but it does not necessarily mean the panel and PC are communicating. If the **Transfer** button is dim, then the panel and PC are not communicating. If a PLC is connected to the serial port of the panel, try disconnecting it. If this corrects the problem, then check your grounding for the PLC and the panel. If this does not correct the problem, see the *C-more* Programming Software Installation Guide for reinstalling the USB driver.

- 2.) When using an **Ethernet** connection to communicate between the touch panel and the PC and the communications does not seem to be working, the first area to check is the Ethernet status indicators located next to the **10/100 Base-T Ethernet Port** on the rear of the panel. The **Link Status LED** must be displaying a **Steady Green**.

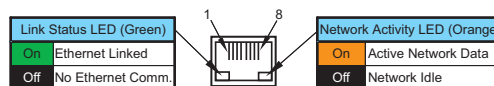



## No Communications between Panel and PC (Personal Computer) (cont'd)

If using an Ethernet connection to program the touch panel, there are two basic ways to make the connection. You can use a “crossover” Ethernet cable to make a direct connection between

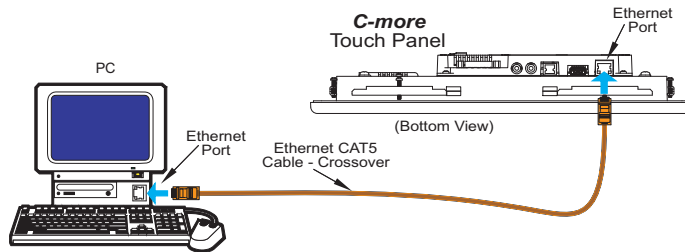

the touch panel and the PC or a “straight-thru” Ethernet cable from the touch panel to a hub, switch, etc. that is also connected to the PC.

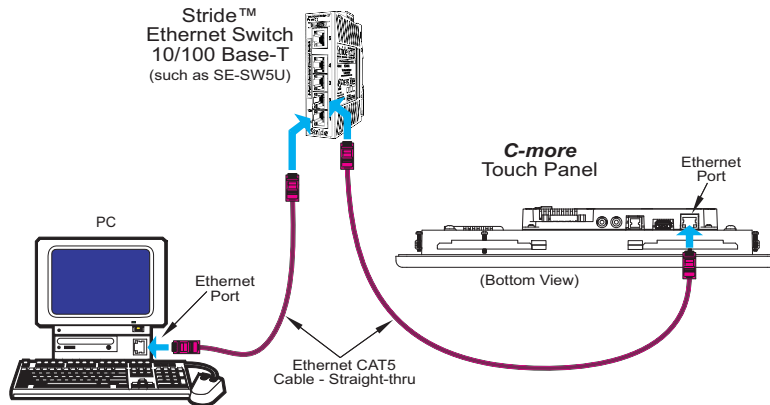

Use the *C-more* programming software to check the status of the Ethernet communications. From the **Navigation** window, select the **Panel** tab. At the bottom of the **Panel** tab is the **Communication Config** dialog box. Select the **Browse** button. If the connection is working the panel will be listed in the online link list. Select the panel and then select OK. If the Ethernet communications to the panel is working, then the **Ethernet** radio button should be checked and there should be a “green” indicator next to the **Ethernet** selection. There should also be an **IP Address** shown in the browse box below the **Ethernet** selection. If the **Ethernet** radio button is “red”, then you will need to check your **Ethernet** cables and connections or **Browse** for the panel. There can also be a conflict with another Ethernet connection that may be using the same **IP Address**. You may want to check the setup both in the touch panel and also in your PC. As a starting point, it is best to start with an assigned **IP Address** and **Subnet mask**, mainly to eliminate **IP addressing conflicts**. Use the *C-more* programming software and open the **Touch Panel Network** dialog box under the **Main Menu's Setup** drop down menu. Click on the **Ethernet Port** tab to display the dialog box used to set up the touch panel's **Ethernet** port.

Another cause of an Ethernet communications problem that may be encountered, is the touch panel doesn't show up in the node list, which can be caused by the PC having a firewall.

## No Communications between Panel and PC (Personal Computer) (cont'd)

The figure below shows the **Touch Panel Network** dialog box with the **Ethernet port** tab opened. The **Save settings to Project** check box is checked and we are using the **Use the following IP Address** selection by checking its radio button. The subnet (192.168.X.X) and the subnet mask (255.255.0.0) must be the same for both the panel and the PC. See the *C-more* programming software on-line help for additional details regarding the **Touch Panel Network**.

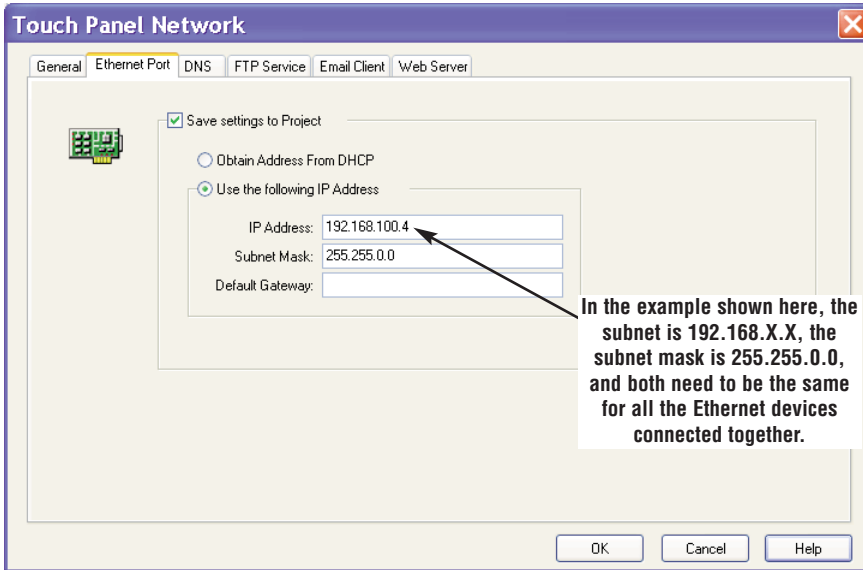

The **IP Address** assigned to the touch panel can also be checked or edited by using the system setup screens built into the touch panel. See **Chapter 5: System Setup Screens** for additional information.

The figure below shows a different example of the panel's **System Setup Screens' Ethernet Port** dialog box for configuring the **Ethernet** port. Again, make sure the subnet (172.22.X.X) and subnet mask (255.255.0.0) is the same for both the panel and the PC.

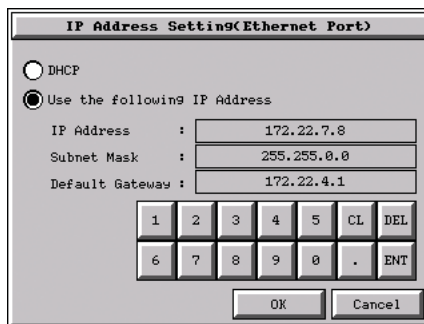

## No Communications between Panel and PC (Personal Computer) (cont'd)

Another option for accessing the IP Address assigned to the touch panel is to use the *C-more* Programming Software. Open the **Navigation** window's **Panel** tab and click on the **Browse** button under the **Communication** window at the bottom. This will open the **Ethernet Connection Setup** window. The **Online Link List** tab will show all of the connected panels. If none are shown, try clicking the **Browse Network** button to search for attached devices. Double click on the **Panel Name** you want to access and this will bring up the **Change IP Address** window. In this window changes can be made to the panel's name, IP address, subnet mask, and default gateway.

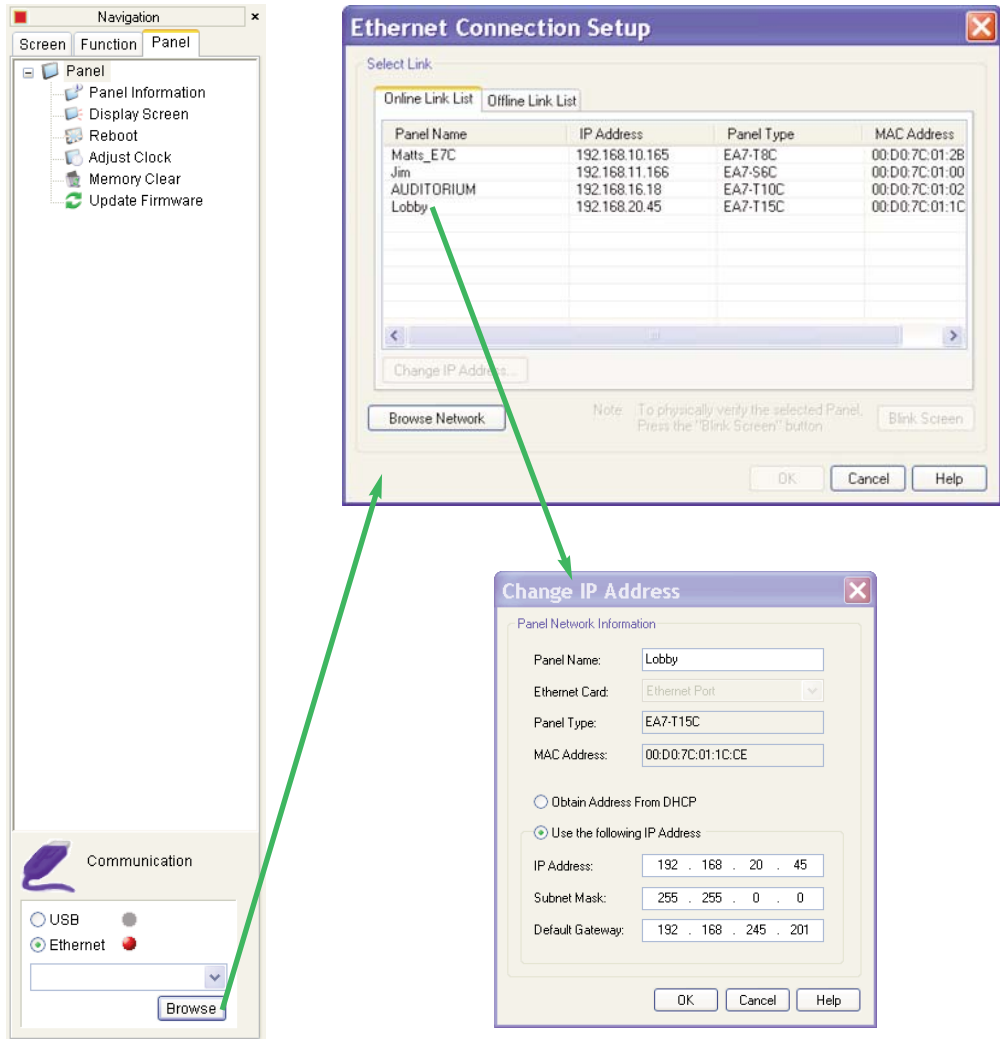

### No Communications between Panel and PC (Personal Computer) (cont'd)

Check the IP Address setting of the PC by opening the Windows operating system's **Control Panel** and then selecting the **Network Connections** utility. Click on **Properties**, scroll down to **Internet Protocol (TCP/IP)** and click **Properties**. The **Internet Protocol (TCP/IP) Properties** dialog box will open. Again, make sure the **Subnet Mask** is set the same for both the panel and the PC and also make sure that the **IP Addresses** do not conflict.

*Note: If a DHCP Server is being used to obtain the IP Address for the PC, there are ways to identify the IP Address. For example, if using Windows XP, open a Command Prompt (Run > CMD) and type IPCONFIG /ALL. A list of all Ethernet assignments for the PC will be shown.*

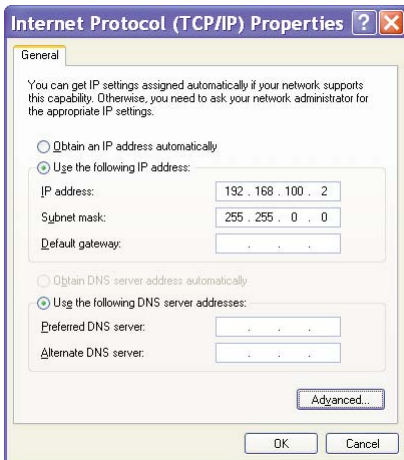
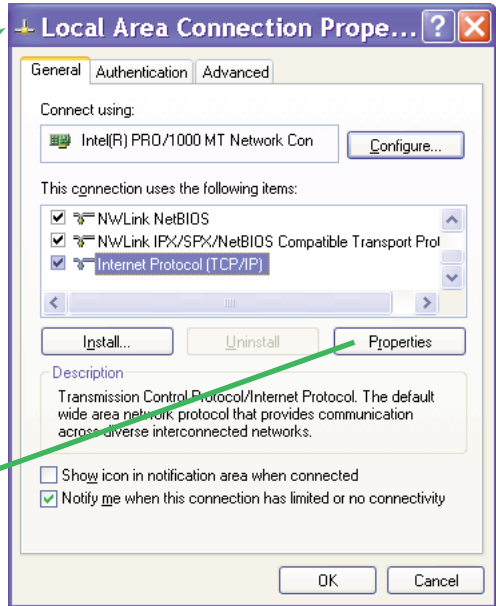
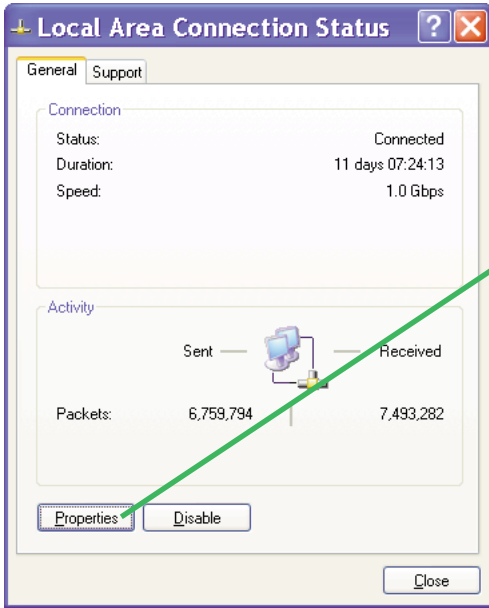

## No Communications between Panel and PLC

The communications between the *C-more* touch panel and designated PLC or controlling device can be accomplished by either a serial connection to the panel's 15-pin PLC Communications Port or by an Ethernet connection to the panel's 10/100 Base-T Ethernet Port. (Ethernet available on full feature units only.)

- 1.) If the touch panel and PLC are connected serially and the communications have seemed to stop working, then first check the TxD and RxD status indicators on the rear of the panel for activity.

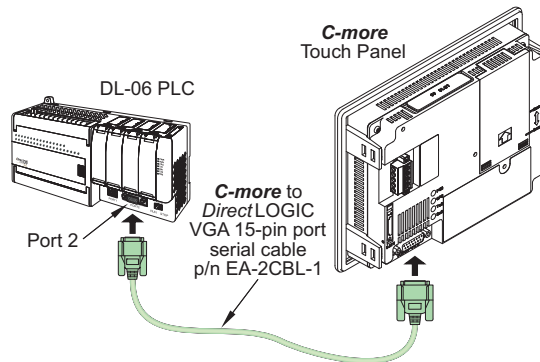

If there is no activity on one or both the TxD and RxD status indicators, then it should be suspected that either:

- serial comm port settings are incorrect
- the cable is bad and needs to be replaced
- the serial port on the panel is defective
- the PLC serial port is bad

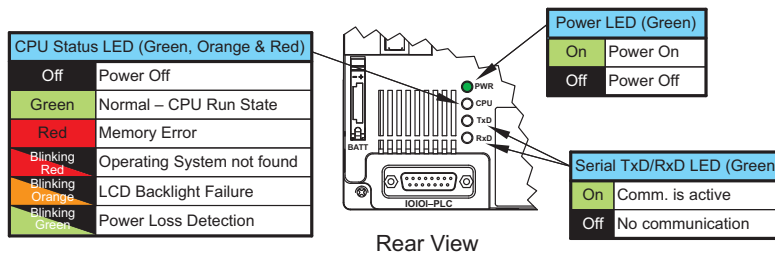

The status indicators will show activity whether the serial communications is wired for RS-232 or RS-422/485.

Electrical noise, pulse generating wiring and/or improper grounding can also cause problems with communications. Refer to the **Electrical Noise Problems** section on page 8-17 for additional help.

(Serial connections between the touch panel and PLC continued on next page.)

## No Communications between Panel and PLC (cont'd)

The serial port on the *C-more* touch panel can be tested using the panel's system setup screens. Access the **Main Menu** of the panel's system setup screens, press the **Test Menu** button and then press the **Test Comm. Port** button. You will need to fabricate a **Loop Back Connector** for the type of serial connection that is being used in your application, either RS-232 or RS-422/485, per the wiring diagrams shown below. Plug the loop back connector into the panel's 15-pin PLC serial communications port and then press the **Loop Back Test** button to run the test. See **Chapter 5: System Setup Screens** for additional information.

Loop back connector wiring diagrams:

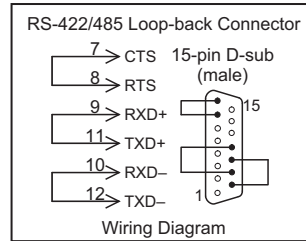
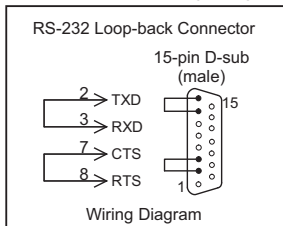

System setup screens **Test Comm. Port** dialog boxes:

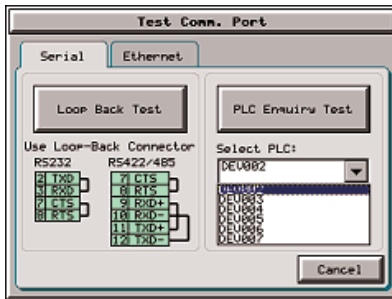

The **PLC Enquiry Test** can also be performed to determine if the **Ethernet** communication is working correctly between the panel and designated PLC .

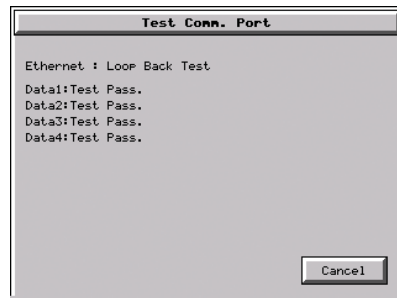
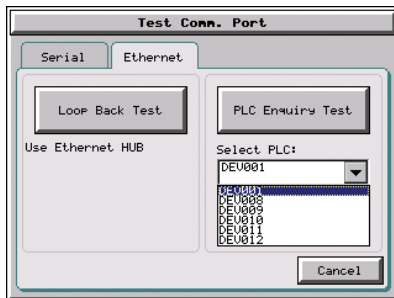

(Ethernet connections between the touch panel and PLC continued on next page.)

## No Communications between Panel and PLC (cont'd)

2.) If using an **Ethernet** connection between the touch panel and the PLC, and there is a problem with the communications, the first area to check is the **Ethernet** status indicators located next to the **10/100 Base-T Ethernet Port** (shown below) on the rear of the panel.

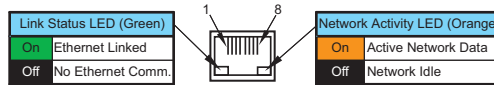

There are two basic ways to make the connection. You can use a crossover **Ethernet** cable (shown below) to make a direct connection between the touch panel and the PLC or a

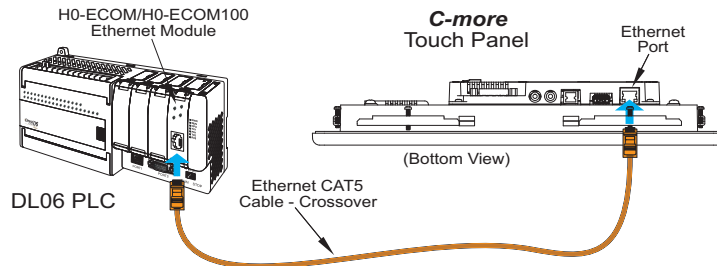

regular **Ethernet** cable (shown below) from the touch panel to a hub, switch, etc. that is also connected to the PLC.

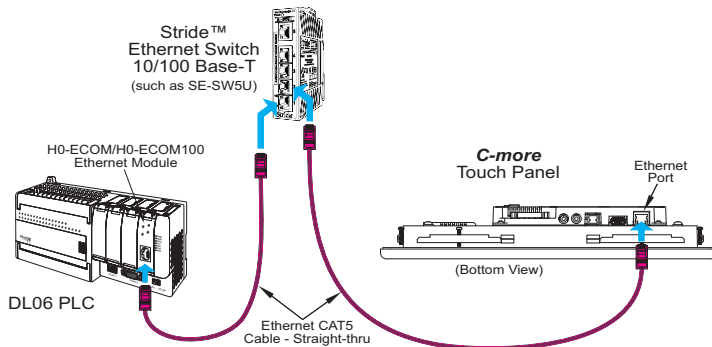

Check the status indicators that may be included with the **Ethernet** communications module or device that is part of the PLC. Refer to the PLC's **Ethernet** user manual for further troubleshooting information.

(**Ethernet** connections between the touch panel and PLC continued next page.)

### No Communications between Panel and PLC (cont'd)

The Ethernet port on the *C-more* touch panel can be tested by using the panel's system setup screens. Access the **Main Menu** of the panel's system setup screens, press the **Test Menu** button and then press the **Test Comm. Port** button. Select the Ethernet tab in the Test Comm. Port dialog box, make sure the Ethernet port is connected to an Ethernet hub or other Ethernet communications device, and then press the **Loop Back Test** button to run the test. See **Chapter 5: System Setup Screens** for additional information.

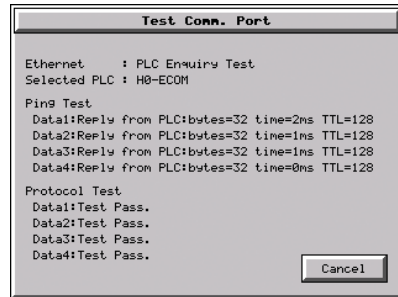
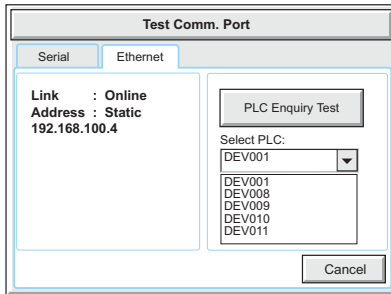

If a PC running the *C-more* programming software is connected to the Ethernet network that is also connected to both the touch panel and PLC, then certain functions in the software, such as the **Main Menu's Setup** drop down selection for **Panel Manager** or **Touch Panel Network** and the **Main Menu's Panel** drop down selection for **Panel Information**, can be used to help troubleshoot problems with the touch panel's communications and operation. See the *C-more* programming software's on-line help for additional information.

### IP Address in System Setup Screens displays 0.0.0.0

**Note:** If entering an IP Address for the *C-more* touch panel using the **System Setup Screens**, and the IP Address keeps displaying 0.0.0.0, even after entering an IP address, the panel is not functionally connected to an active network. Either the cable, hub, or switch is bad. The entered IP Address is stored in the panel's memory, but won't show up until a good connection is established. Keep in mind that if in the *C-more* programming software's **Touch Panel Network** dialog box, under the **Ethernet Port** tab, you have checked the **Save settings to Project** check box and have entered an IP Address of 0.0.0.0, then anytime the project is transferred to the panel, the panel's IP Address will be overwritten with the entered address.



## Difficulty Connecting to the Panel over the Internet (Web server and Remote Access features)

- 1) Refer to the software help file topics **Touch Panel Network** and **Remote Access Setup** for information on configuring the Remote Access accounts, the Web Server Function and the panel IP Attributes.
- 2) In the Ethernet Port tab if DHCP is selected for assigning the IP address, verify the correct address of the panel. The IP address assigned by DHCP may change over time.
- 3) Note that the Web Server Function must be enabled on the Web Server tab before the Remote Access Server Function can be accessed on the panel.
- 4) Verify that the correct TCP ports have been opened on the router controlling access to the network where the C-more panel resides.
- 5) If two C-more panels are on a network behind a firewall and they have the same **Remote Access port number**, the router will use the first entry in the Port Forwarding setup that it encounters. The same C-more panel will always come up even if the two panels have two different Web Server Port numbers.
- 6) When entering the URL in Internet Explorer to connect the C-more web server using a port number other than the default (80), be sure to use the full URL text including the prefix "http://". The URL should be <http://xxx.xxx.xxx.xxx:aaaaa> where xxx.xxx.xxx.xxx is the IP address of the panel and aaaaa is the port number configured in the Web Server tab of the Touch Panel Network setting.

### PLC Protocol Error Codes

The *C-more* touch panel includes built-in PLC communication protocol diagnostics that monitor the exchange of data between the panel and the PLC. The diagnostics look for the proper exchange of data, correct handshaking signals, addressing errors, incorrect data bytes, wrong packet format, etc. The diagnostics also monitor and report any of the errors that the designated PLC would normally generate if there is a problem with the PLC's communications. Each brand of PLC has its own unique set of diagnostic errors that are typically communicated over the PLC's communications port. The PLC generated errors are interpreted by the *C-more* software. See the PLC manufacturer's user manuals for additional details on the designated PLC's errors.

If a *C-more* communications error does occur, the error message will be displayed in the upper left of the *C-more* screen and the **Error Code** is recorded in the panel's error log. If a PLC error occurs, the PLC error code number will appear across the top of the screen, the PLC error message may not be included in some cases. The error log can be viewed using the system setup screens. See **Chapter 5: System Setup Screens** under the **Information** window to bring up the **Error** tab which includes a description of the logged data.

A detailed list and description of the various PLC protocol errors can be found in **Appendix A: PLC Protocol Error Codes**.

PLC Protocol Error Codes example:

Error Codes for <i>Direct</i> LOGIC – K-Sequence		
Error Code	Error Message	Description
PLC-001	PLC Communication Timeout (for single PLC) %Device% PLC Communication Timeout (for multiple PLCs, such as RS-422/485)	A timeout occurred after sending a request to the PLC %Device%. %Device% indicates the device name, such as DEV001. Example error message for multiple PLCs: DEV001 PLC Communication Timeout
PLC-002	NAK received from PLC	A negative acknowledgement (NAK) control code has been generated during a read/write request.
PLC-004	STX is not found	A Start of Text (STX) control code was not found in the data packet received from the PLC.

## Touch Panel Runtime Errors

The *C-more* touch panel includes built-in diagnostics that check for proper operation of the panel when it is running a project that has been transferred to its memory. Faults detected while the panel is running will produce a “Runtime” error. These errors are displayed in the upper left of the panel’s display and are also recorded in the panel’s error log. The error log can be viewed using the system setup screens. See **Chapter 5: System Setup Screens** under the **Information** window to bring up the **Error** tab which includes a description of the logged data.

A detailed list and description of the various touch panel runtime errors can be found in **Appendix B: Touch Panel Runtime Errors**.

Touch Panel Runtime Errors example:

No.	Error Log Code	Error Message Located at upper left of screen	Error Message Tag	Tag Error Code Value	System Screen Info > Error	Cause
<b>Log Error</b>						
1	RTE-001	Log Failed. Not enough Memory Space in %Device%	SYS ERR ERRORCODE	2001	MM/DD/YY HH/MM/SS Error Code RTE-001	The size of the destination memory is not large enough to store the data.
2	RTE-002	Log Failed. %Device% cannot be found	SYS ERR ERRORCODE	2002	MM/DD/YY HH/MM/SS Error Code RTE-002	No device available or the device is defective.
<b>Battery</b>						
1	RTE-031	Low Battery	SYS ERR ERRORCODE	2031	MM/DD/YY HH/MM/SS Error Code RTE-031	The panel’s backup battery voltage level has fallen below 1.8 VDC and should be replaced.

### Panel Constantly Displays “Initializing” when Powering up

If the touch panel constantly displays a message reading “Initializing” while powering up, then check the following possible causes.

- 1.) The project that is loaded into the panel’s internal SDRAM memory is corrupted. Either use the *C-more* programming software to clear the panel’s memory and re-transfer the project to the touch panel, or press the upper left corner of the touch panel screen while powering up to bypass the project and go directly to the **System Setup Screen** menu. Select the **Memory** menu, and use either the **Clear Memory** or **Set to Factory Default** utility to clear the panel’s memory and re-transfer the project to the touch panel.
- 2.) A CompactFlash memory card has been plugged into the CF1 slot and the CompactFlash either has no project stored on it or the project is corrupted. Remove the CompactFlash memory card from the CF1 slot and either load the project to the panel’s internal Flash memory, or use a CF card reader connected to a PC to clear and re-format the CompactFlash card, or try a different CompactFlash memory card.



---

**Note:** In the Error Log you may find the error RTE-500 - Check Sum Error, which is defined as “Memory in the panel has been corrupted by power loss, etc.” If this is the case, try cycling power to the panel, re-transfer the project to the panel, and re-transfer the firmware, etc. in sequential steps to try to correct the problem.

---

### Data not Logging Problems

If the data log is missing entries, or a Runtime Error for the Log Errors as shown in **Appendix B: Touch Panel Runtime Errors** is seen, then check the following possible causes.

- 1.) Check that the memory devices, that were selected for **Data Storage** under the *C-more* programming software’s **Main Menu - Setup** drop down - **Panel Manager** dialog box, are plugged into their proper location. Alarms, messages and screen captures can be independently selected to be saved to either a USB pen drive plugged into the USB Port - Type A, or a CompactFlash memory card plugged into CF1 or CF2. (Full feature units only.)
- 2.) The memory device could be bad. If possible, check it by plugging it into a PC that has the ability to access the memory device. Also, not all USB devices are compatible with the *C-more* touch panels. Try using the *AutomationDirect* USB Pen Drive, p/n SDCZ4-2048-A10. Check **System Screen, Memory** for the presence of the USB device inserted.

## Loss of Date/Time and Retentive Data

If power is cycled to the *C-more* touch panel and it is then noticed that either the **Date/Time** of the panel is no longer correct, or any data that has been setup to be retentive is inaccurate, most likely the backup battery is exhausted and needs to be replaced. See **Chapter 9: Replacement Parts** for additional information on replacing the panel's battery.



D2-BAT-1



**CAUTION - The battery used in this device may present a risk of fire or chemical burn if mistreated. Do not recharge, disassemble, heat above 100 °C (212 °F) or incinerate. Replace battery with AutomationDirect part number D2-BAT-1 or CR2354 only. Use of another battery may present a risk of fire or explosion. Dispose of used battery properly. Keep away from children.**

**Perchlorate Material, special disposal handling may apply**

## Electrical Noise Problems

Noise is one of the most difficult problems to diagnose. Electrical noise can enter a system in many different ways which fall into one of two categories, conducted or radiated. It may be difficult to determine how the noise is entering the system but the corrective actions for either of the types of noise problems are similar.

- Conducted noise is when the electrical interference is introduced into the system by way of an attached wire, panel connection, etc. It may enter through a power supply connection, the communication ground connection, or the chassis ground connection.
- Radiated noise is when the electrical interference is introduced into the system without a direct electrical connection, much in the same manner as radio waves.

While electrical noise cannot be eliminated, it can be reduced to a level that will not affect the system.

- Most noise problems result from improper grounding of the system. A good earth ground can be the single most effective way to correct noise problems. If a ground is not available, install a ground rod as close to the system as possible. Ensure all ground wires are single point grounds and are not daisy chained from one device to another. Ground metal enclosures around the system. A loose wire can act as a large antenna, introducing noise into the system. Therefore, tighten all connections in your system. Loose ground wires are more susceptible to noise than the other wires in your system. Review **Chapter 4: Installation & Wiring** if you have questions regarding how to ground the touch panel.
- Electrical noise can enter the system through the power source for the touch panel. Installing a properly wired isolation transformer (neutral grounded) for all AC sources can help the problem, but only if wired correctly. DC sources should be well-grounded good quality supplies.
- Never run communication cables or low-voltage power wiring close to high voltage wiring or pulse generating wiring that controls such devices as solenoids, servos, VFOs, etc.