



Errata Sheet

This Errata Sheet contains corrections or changes made after the publication of this manual.

Product Family:	DL205 / DL305	Date:	September 2018
Manual Number	D2-DCM		
Revision and Date	2nd Edition; February 2003		

Change to Table of Contents

There is a typo on the first page of the Table of Contents. "Install" is spelled "Insall" for the section named "Install the D2-DCM".

Change to Page 2. Introduction

Add the following note to this page:

NOTE: The D3-DCM module is only supported by the D3-350 processor only.

Change to Page 7. Specifications

In the Operating Specifications table, revise the "CPU Required" entry. It should say:

D2-240 (firmware V1.8 or later), D2-250-1 and D2-260

Change to Page 11. Building the Cable

The NOTE at the bottom of the page is incorrect. Only the D2-230 and D2-240 CPUs support RS232 only. D2-250(-1) and D2-260 CPUs support RS232/422/485 without extra hardware.

Change to Page 12. Building the Cable (continued)

Change the reference in the first paragraph to "Belden 9855" cable to "AutomationDirect L19772-1 (Belden 8102) or equivalent".

Change to Page 13. Building the Cable (continued)

In the first paragraph, change the last sentence to "For example, AutomationDirect L19772-1 (Belden 8102) or equivalent has a nominal characteristic impedance of 100 ohms".

In the top wiring drawing ("Line-to-Line Termination for the D2-DCM"), change both "120 Ohm Resistor" callouts to "100 Ohm Resistor".

In the bottom wiring drawing, change the "65 Ohm Resistors" callouts to "51 Ohm Resistors".

In the top drawing, move the termination resistor on the left connector (Master) from the 24-25 pins to the 16-17 pins.



Errata Sheet

This Errata Sheet contains corrections or changes made after the publication of this manual.

The Change to Page 17. D2–DCM Switch Settings

Add the following note near the first bullet point, "**Direct**NET Slave":

NOTE: Although it is not listed in the switch settings, K-sequence is also available whenever the D2–DCM is set for DirectNET Slave operation.

Change to Page 18. D2–DCM Switch Settings (continued)

There is an error in the last paragraph, "Response Delay Time". The first sentence refers to switch "SW4". It should say "SW5". (SW4 is used for firmware updates.)

Change to Page 21. Install the D2–DCM and Starting the Network

Add the following note to this page:

D3-DCM cannot be mounted in the farthest slot from the CPU in a base. It requires 300 mA of +9 V base power. Make sure you will not exceed the available base power budget by installing the D3-DCM.

See the DL305 User Manual for complete details on power budget calculations.

Changes to Appendix A. Cable Diagrams

Page A-4. Point-to-Point RS422 D2–DCM as Master

In the lower left drawing there are some pin number errors for the DL405 port 1 25-pin connector. The correct pin numbers are:

19 +RTS (not 10 as shown)

18 -RTS (not 11 as shown)

11 +CTS (not 12 as shown)

23 -CTS (not 13 as shown)

In the top set of drawings, change the callout that says "DL405 CPU Bottom Port" to DL405 Port 1"



Errata Sheet

This Errata Sheet contains corrections or changes made after the publication of this manual.

Change to Appendix A. Cable Diagrams (continued)

Page A-7. Revisions were made to both drawings:

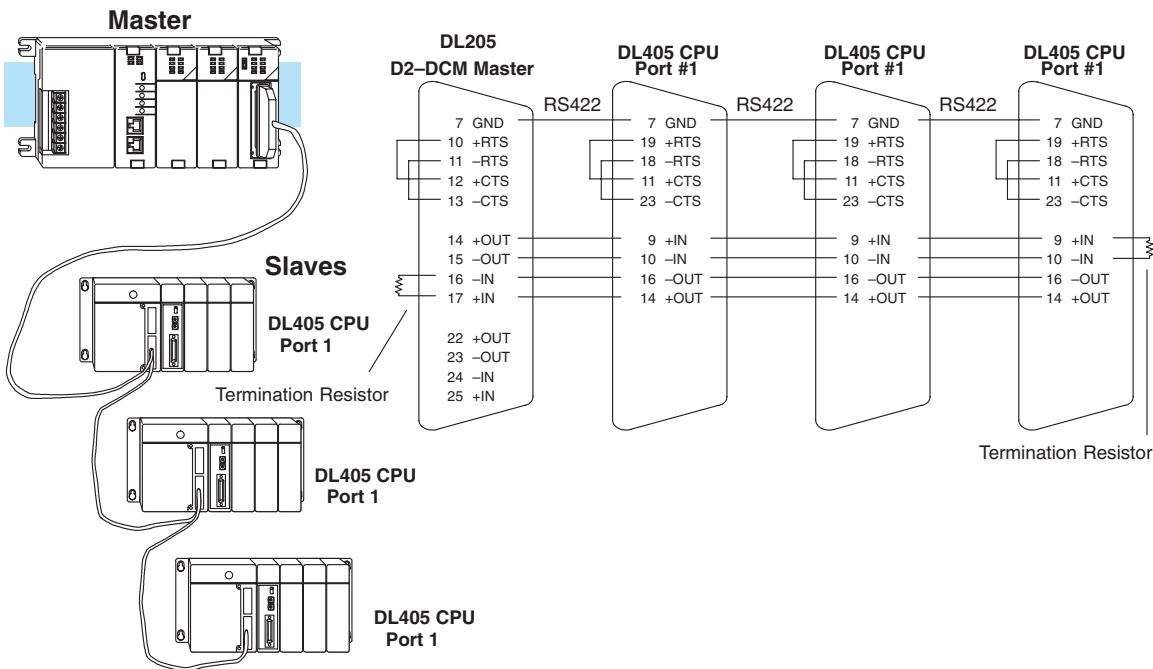
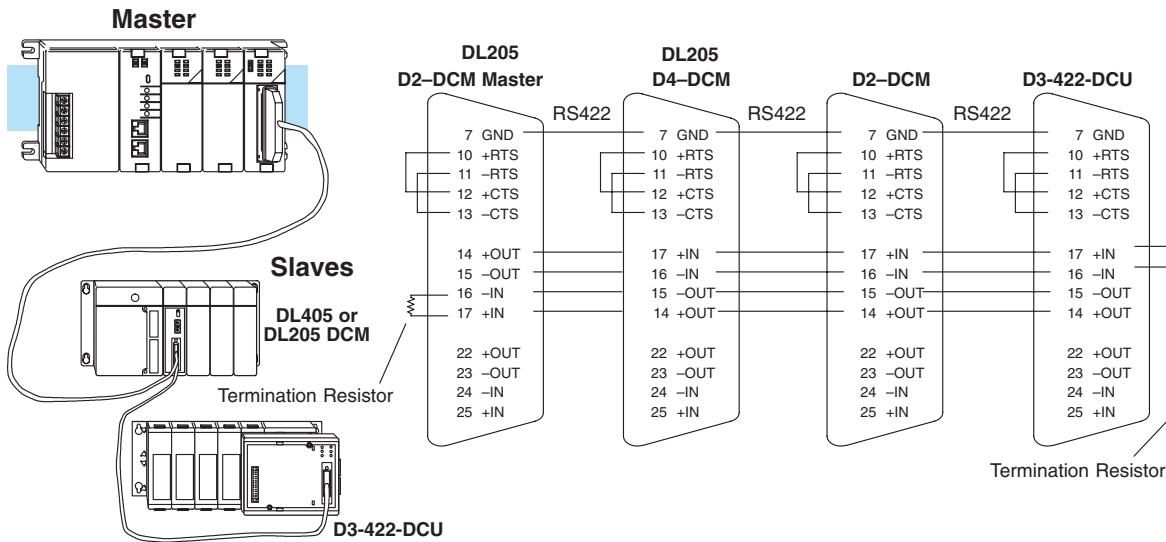

Change to Appendix A. Cable Diagrams (continued)

Page A-8. Change the call-out that says "DL240 CPU Bottom Port or DL450 Phone Jack" to: "DL450 Port 2 (RJ12)"



D2-DCM

Data Communications

Module

Manual Number D2-DCM-M



WARNING

Thank you for purchasing automation equipment from **Automationdirect.com**[™]. We want your new **DirectLOGIC**[™] automation equipment to operate safely. Anyone who installs or uses this equipment should read this publication (and any other relevant publications) before installing or operating the equipment.

To minimize the risk of potential safety problems, you should follow all applicable local and national codes that regulate the installation and operation of your equipment. These codes vary from area to area and usually change with time. It is your responsibility to determine which codes should be followed, and to verify that the equipment, installation, and operation are in compliance with the latest revision of these codes.

At a minimum, you should follow all applicable sections of the National Fire Code, National Electrical Code, and the codes of the National Electrical Manufacturer's Association (NEMA). There may be local regulatory or government offices that can also help determine which codes and standards are necessary for safe installation and operation.

Equipment damage or serious injury to personnel can result from the failure to follow all applicable codes and standards. We do not guarantee the products described in this publication are suitable for your particular application, nor do we assume any responsibility for your product design, installation, or operation.

*Our products are not fault-tolerant and are not designed, manufactured or intended for use or resale as on-line control equipment in hazardous environments requiring fail-safe performance, such as in the operation of nuclear facilities, aircraft navigation or communication systems, air traffic control, direct life support machines, or weapons systems, in which the failure of the product could lead directly to death, personal injury, or severe physical or environmental damage ("High Risk Activities"). **Automationdirect.com**[™] specifically disclaims any expressed or implied warranty of fitness for High Risk Activities.*

For additional warranty and safety information, see the Terms and Conditions section of our Desk Reference. If you have any questions concerning the installation or operation of this equipment, or if you need additional information, please call us at 770-844-4200.

This publication is based on information that was available at the time it was printed. At **Automationdirect.com**[™] we constantly strive to improve our products and services, so we reserve the right to make changes to the products and/or publications at any time without notice and without any obligation. This publication may also discuss features that may not be available in certain revisions of the product.



Trademarks

This publication may contain references to products produced and/or offered by other companies. The product and company names may be trademarked and are the sole property of their respective owners. **Automationdirect.com**[™] disclaims any proprietary interest in the marks and names of others.

Copyright 2001, Automationdirect.com[™] Incorporated
All Rights Reserved

No part of this manual shall be copied, reproduced, or transmitted in any way without the prior, written consent of **Automationdirect.com**[™] Incorporated. **Automationdirect.com**[™] retains the exclusive rights to all information included in this document.



AVERTISSEMENT



Nous vous remercions d'avoir acheté l'équipement d'automatisation de **Automationdirect.com™**. Nous tenons à ce que votre nouvel équipement d'automatisation **DirectLOGIC™** fonctionne en toute sécurité. Toute personne qui installe ou utilise cet équipement doit lire la présente publication (et toutes les autres publications pertinentes) avant de l'installer ou de l'utiliser.

Afin de réduire au minimum le risque d'éventuels problèmes de sécurité, vous devez respecter tous les codes locaux et nationaux applicables régissant l'installation et le fonctionnement de votre équipement. Ces codes diffèrent d'une région à l'autre et, habituellement, évoluent au fil du temps. Il vous incombe de déterminer les codes à respecter et de vous assurer que l'équipement, l'installation et le fonctionnement sont conformes aux exigences de la version la plus récente de ces codes.

Vous devez, à tout le moins, respecter toutes les sections applicables du Code national de prévention des incendies, du Code national de l'électricité et des codes de la National Electrical Manufacturer's Association (NEMA). Des organismes de réglementation ou des services gouvernementaux locaux peuvent également vous aider à déterminer les codes ainsi que les normes à respecter pour assurer une installation et un fonctionnement sûrs.

L'omission de respecter la totalité des codes et des normes applicables peut entraîner des dommages à l'équipement ou causer de graves blessures au personnel. Nous ne garantissons pas que les produits décrits dans cette publication conviennent à votre application particulière et nous n'assumons aucune responsabilité à l'égard de la conception, de l'installation ou du fonctionnement de votre produit.

Nos produits ne sont pas insensibles aux défaillances et ne sont ni conçus ni fabriqués pour l'utilisation ou la revente en tant qu'équipement de commande en ligne dans des environnements dangereux nécessitant une sécurité absolue, par exemple, l'exploitation d'installations nucléaires, les systèmes de navigation aérienne ou de communication, le contrôle de la circulation aérienne, les équipements de survie ou les systèmes d'armes, pour lesquels la défaillance du produit peut provoquer la mort, des blessures corporelles ou de graves dommages matériels ou environnementaux ("activités à risque élevé"). La société **Automationdirect.com™** nie toute garantie expresse ou implicite d'aptitude à l'emploi en ce qui a trait aux activités à risque élevé.

Pour des renseignements additionnels touchant la garantie et la sécurité, veuillez consulter la section Modalités et conditions de notre documentation. Si vous avez des questions au sujet de l'installation ou du fonctionnement de cet équipement, ou encore si vous avez besoin de renseignements supplémentaires, n'hésitez pas à nous téléphoner au 770-844-4200.

Cette publication s'appuie sur l'information qui était disponible au moment de l'impression. À la société **Automationdirect.com™**, nous nous efforçons constamment d'améliorer nos produits et services. C'est pourquoi nous nous réservons le droit d'apporter des modifications aux produits ou aux publications en tout temps, sans préavis ni quelque obligation que ce soit. La présente publication peut aussi porter sur des caractéristiques susceptibles de ne pas être offertes dans certaines versions révisées du produit.

Marques de commerce

La présente publication peut contenir des références à des produits fabriqués ou offerts par d'autres entreprises. Les désignations des produits et des entreprises peuvent être des marques de commerce et appartiennent exclusivement à leurs propriétaires respectifs. **Automationdirect.com™** nie tout intérêt dans les autres marques et désignations.

Copyright 2001, **Automationdirect.com™** Incorporated

Tous droits réservés

Nulle partie de ce manuel ne doit être copiée, reproduite ou transmise de quelque façon que ce soit sans le consentement préalable écrit de la société **Automationdirect.com™** Incorporated. **Automationdirect.com™** conserve les droits exclusifs à l'égard de tous les renseignements contenus dans le présent document.

Manual Revisions



If you contact us in reference to this manual, please remember to include the revision number.

Title: DL205 Data Communications Module

Manual Number: D2-DCM-M

Issue	Date	Description of Changes
Original	5/96	Original Issue
Rev. A	5/98	Downsize to spiral Rev. A Minor changes
2nd Edition	2/03	Upgrade with DL06 and DirectSOFT32 ; added MDM-TEL information



Table of Contents

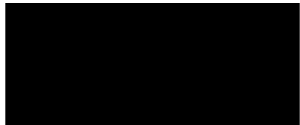

Introduction

Overview	2
The Purpose of this Manual	2
Supplemental Manuals	2
Who Should Read this Manual	2
Technical Support	2
Conventions Used	3
Key Topics for Each Chapter	3
D2–DCM Hardware	4
Applications	5
As a DirectNET Interface	5
As an Extra Communication Port	6
As a MODBUS) Network Interface	6
Specifications	7
Environmental Specifications	7
Operating Specifications	7
Using your D2–DCM– Five Steps	8

Building the Cable

Building the Communication Cable	9
Consideration 1: Physical Configuration	10
Consideration 2: Electrical Specification RS232C or RS422	11
Consideration 3: Cable Schematics	11
Consideration 4: Cable Specifications	12
Consideration 5: Installation Guidelines	12
A Quick Test Cable	15

Setting the Switches

Setting the D2–DCM switches	16
Host Computer or Operator Interface Connection	16
DirectNET Interface Connection	16
D2–DCM Switch Settings	17
Address Selection Switch	19
Online / Offline Switch	20

Install



Install the D2–DCM

Install the D2–DCM and Starting the Network	21
Install the D2–DCM	21
Connect the Cables	21
If you're using DirectNET...	21
If you're using an Operator Interface or Host Computer...	22
If you're using MODBUS)...	22

Verification & Troubleshooting

Verification and Troubleshooting	23
Troubleshooting Quick Steps	24
Troubleshooting Chart	25

Appendix A: Cable Diagrams

Point-to-Point RS232C D2–DCM as Master	A–2
Point-to-Point RS232C PC as Master	A–3
Point-to-Point RS422 D2–DCM as Master	A–4
Point-to-Point RS422 PC as Master	A–6
Multidrop RS422 D2–DCM as Master	A–7
Multidrop RS422 PC as Master	A–9
DV–1000 Cable	A–10

Appendix B: RLL Communications Programs

Why do you need networking instructions in your RLL?	B–2
The Master Initiates Requests	B–2
Why Ladder Logic?	B–2
Identifying the master and slave locations & addresses	B–4
Specifying the amount of data to transfer	B–5
Designating the master station memory area	B–6
Identifying the slave station memory area to read or write	B–7
Controlling the communications	B–9
Communications Special Relays	B–9
Multiple Read and Write Interlocks	B–10

Appendix C: Using the D2–DCM with MODBUS

Introduction	C–2
How Does the D2–DCM work with MODBUS?	C–2
MODBUS Function Codes Supported	C–3
MODBUS Data Types Supported	C–3
Determining the MODBUS Address	C–4
If the Host Software Requires the Data Type and Address... ..	C–4
Example 1: V2100	C–6
Example 2: Y20	C–6
Example 3: T10 Current Value	C–6
Example 4: C54	C–6
If the Host Software Requires an Address ONLY	C–7
Example 1: V2100 584/984 Mode	C–9
Example 2: Y20 584/984 Mode	C–9
Example 3: T10 Current Value 484 Mode	C–9
Example 4: C54 584/984 Mode	C–9

Appendix D: Using the D2–DCM with Modems

Introduction	D–2
System Components	D–2
Possible Configurations	D–3
Choosing a Modem	D–3
Set the D2–DCM Switches	D–4
Baud Rate & Parity	D–4
Delay Time	D–4
Delay Time Considerations for Networks with DL240 Slaves	D–5
Choose the Proper Cables	D–6
Connecting a Modem to your Personal Computer	D–6
Connecting a Modem to the D2–DCM	D–7
Connecting a Modem to the DL240	D–7



Using the MDM-TEL	D-8
RS232 Connections	D-8
The MDM-TEL Setup Wizard	D-8
D2-DCM as Master	D-9
If You are Using a D2-DCM as Master	D-9
Using DirectSOFT32	D-10
Creating a Modem Link	D-10
Modem Setup	D-10
Configuring the Link	D-14

D2–DCM

Data Communication

Module

In This Manual. . . .

- Introduction
- Building the Communication Cable
- Setting the D2–DCM Switches
- Installing the D2–DCM and Starting the Network
- Verification and Troubleshooting

Overview

The D3-DCM module is only supported by the D3-350 processor only.

The Purpose of this Manual

This manual is designed to allow you to setup and install your DL205 Data Communications Module (D2-DCM). This is the only manual you will need if you are using the D2-DCM as an extra general purpose communication port for your DL205 PLC system. If you plan on using the D2-DCM as a network master or slave for a **DirectNET** network, this manual covers the basic steps for setting up the D2-DCM and the RX/WX instructions needed in your RLL program.

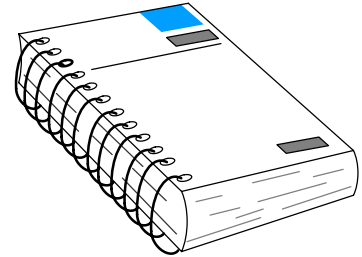

If you plan on using a personal computer as the network master, it may be helpful to read the **DirectNET** manual first. In either case, the **DirectNET** manual can be useful because it provides detailed descriptions of network configurations, various cable connections, etc.

Supplemental Manuals

Depending on which products you have purchased, there may be other manuals that are necessary or helpful for your application. These are some suggested manuals:

User Manuals

- **DirectNET** Network Guide part number DA-DNET-M
- **DirectSoft32** Programming Software part number PC-DSOFT32-M

If you plan to use your D2-DCM to communicate with another PLC, you will need the appropriate user manual for the other PLC.

If you plan to use your D2-DCM module as an interface to HMI or PC Control software or to an Operator Interface panel, you will need to refer to the documentation for that product.

Who Should Read this Manual

If you need an additional communications port for your DL205 PLC and you understand the basics of installing and programming PLCs, this is the right manual for you. This manual gives you the information you need to set up an active port on the D2-DCM module.

Technical Support

We strive to make our manuals the best in the industry and rely on your feedback in reaching our goal. If you cannot find the solution to your particular application, or, if for any reason you need additional technical assistance, please call us at

770-844-4200.

Our technical support team is glad to work with you in answering your questions. They are available **weekdays from 9:00 a.m. to 6:00 p.m. Eastern Time**. We also encourage you to visit our website where you can find technical and nontechnical information about our products and our company.

www.automationdirect.com

Conventions Used



The “light bulb” icon in the left-hand margin indicates a **tip** or **shortcut**.



The “note pad” icon in the left-hand margin indicates a **special note**.

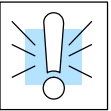

The “exclamation mark” icon in the left-hand margin indicates a **warning** or **caution**. These are very important because the information may help you prevent serious personal injury or equipment damage.

Key Topics for Each Chapter

The beginning of each chapter will list the key topics that can be found in that chapter.

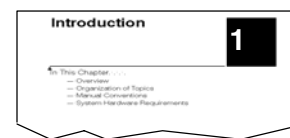

D2-DCM Hardware

The following diagram shows the major D2-DCM components. The address selection switches and the communication dipswitches are of special importance.

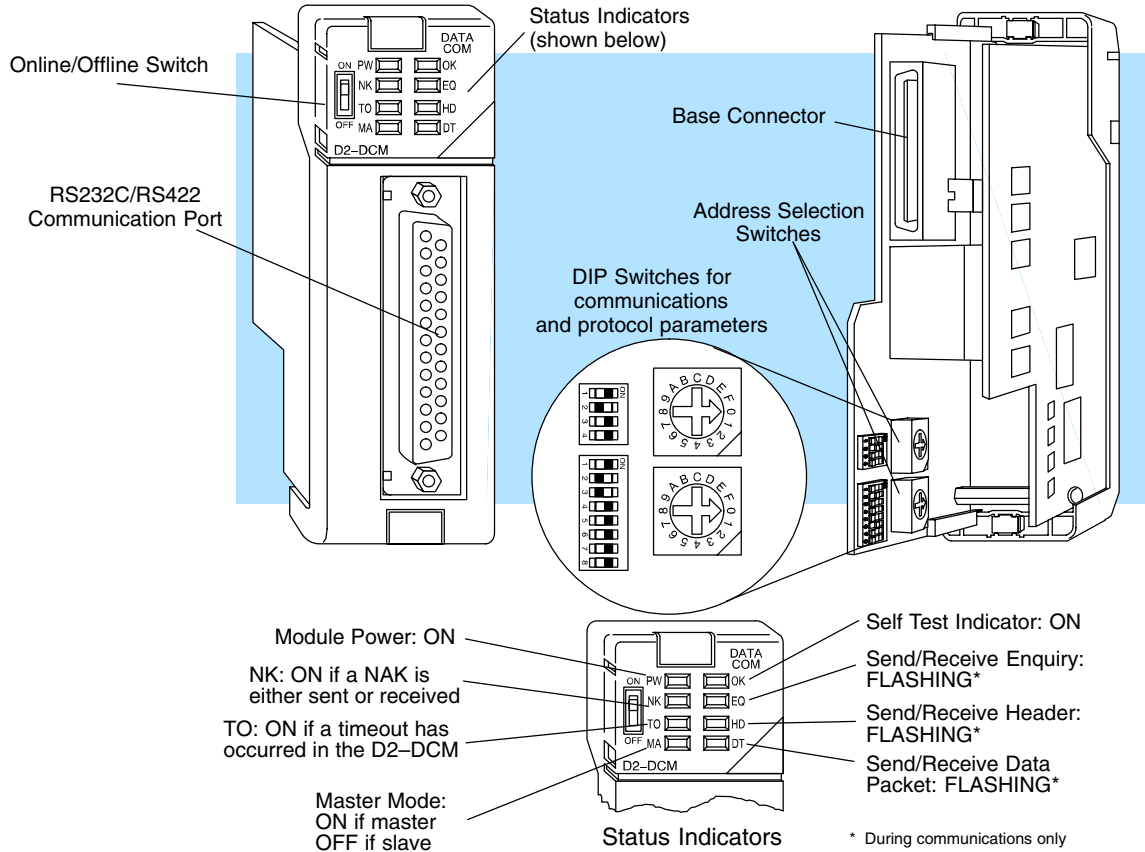

The DL205 Data Communications Module (D2-DCM) is a general purpose communications interface that can be used in a DL205 system that has a D2-240/250-1/260 Central Processing Unit (CPU). **The D2-DCM cannot be used with a DL230 CPU.** The module can go in any base slot, except for Slot 0, which is next to the CPU. This module is primarily used for three reasons.

- As a network master or slave interface to a **DirectNET** network
- As an extra general purpose communications port to connect a personal computer or operator interface
- As a network interface to a MODBUS[®] network using the RTU protocol

Applications

As a *DirectNET* Interface

The D2-DCM can be used as a network interface for applications that require data to be shared between PLCs, or between PLCs and an intelligent device (such as a host computer). The D2-DCM can be configured as either a master or slave station and allows you to upload or download virtually any type of system data including Timer/Counter data, I/O information, and V-memory information.

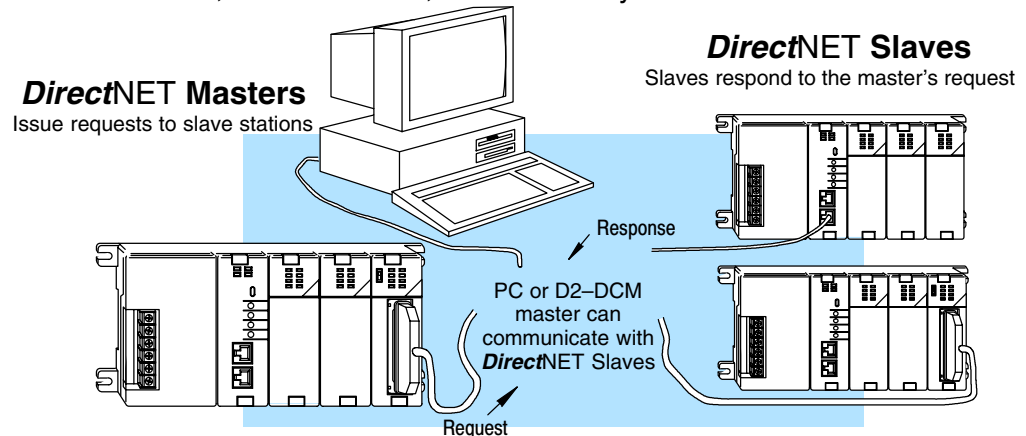

Using a D2-DCM as a Network Master

The DL205 D2-DCM can be used with a D2-240/250-1/260 CPU to serve as a network master. Your CPU must have firmware V1.8 or later. **It cannot be used with a DL230 CPU.** (A master is the network station that *initiates* requests for data from other stations on the network). You simply use special RLL instructions (RX and WX) inside of your RLL program to initiate the data exchange. The D2-DCM takes communication requests issued by the PLC program instructions and automatically converts these requests into network commands that read data from or write data to another network station.

The PLC program is really very simple and only requires a few instructions. Appendix A provides an overview of the instructions. Or, see the *DirectNET* Manual for network details.

Using a D2-DCM as a Network Slave

The D2-DCM can also be used with a D2-240/250-1/260 CPU to serve as a network slave station. **It cannot be used with a DL230 CPU.** In this case, the D2-DCM “listens” to the network for any messages that contain the D2-DCM’s address. The D2-DCM deciphers the network commands, carries out the request to read or write data, and sends confirmation and/or information to the master station.

Possible Slaves

- D2-240/250-1/260 CPU (bottom port)
- D2-240/250-1/260 w/ D2-DCM
- D3-330 or D3-330P w/ DCU
- D3-340 (either port)
- D4-430 (bottom port)
- D4-440 (bottom port)
- D4-450 (phone jack or bottom port)
- Any DL405 CPU w/ D4-DCM

Possible Masters

- D2-240/250-1/260 w/ D2-DCM
- D3-340 CPU (bottom port)
- Any DL405 CPU w/ D4-DCM
- D4-450 CPU (bottom port)
- Host computer w/*DirectSOFT* DSDData Server

As an Extra Communication Port

As an extra communication port, the D2-DCM supports the *DirectNET* protocol just like the bottom port on the D2-240/250-1/260 CPU, but at higher baud rates. In general, if you can connect a device to the bottom port on the D2-240/250-1/260 CPU, then you can also connect the same device to the D2-DCM. These devices can be a variety of things, such as operator interfaces or personal computers.

Since the D2-DCM does not require any programming, you can simply set the D2-DCM communication parameters, connect the appropriate RS232C or RS422 cables, and start transferring data.

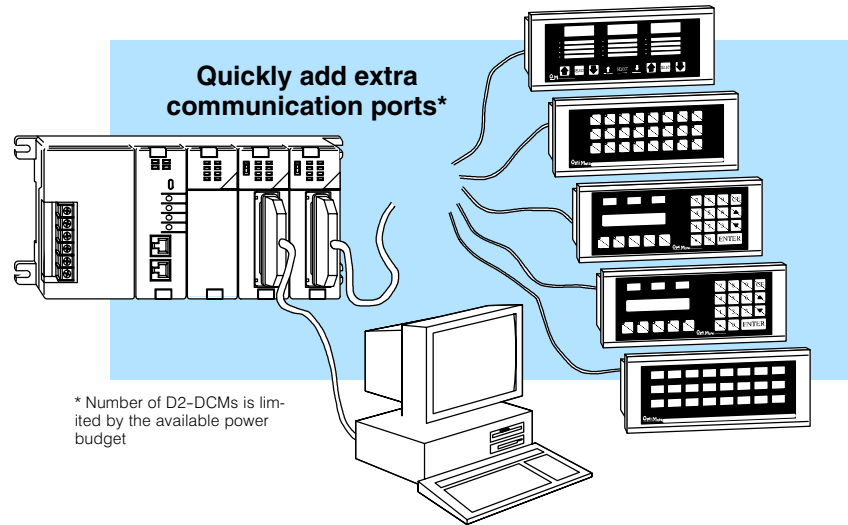

As a MODBUS® Network Interface

The D2-DCM can be used as a slave interface to connect your DL205 system to a MODBUS® network using the MODBUS® RTU protocol. The host system must be capable of issuing the MODBUS® commands to read or write the appropriate data. **Appendix C provides additional information on using the D2-DCM as a MODBUS slave interface.** This manual does not describe the MODBUS® protocol. We recommend that you reference the Gould MODBUS® Protocol Reference Guide (P1-MBUS-300 Rev. B) for details on the protocol. There may be more recent editions of this manual, so check with your MODBUS® supplier before ordering the documentation.

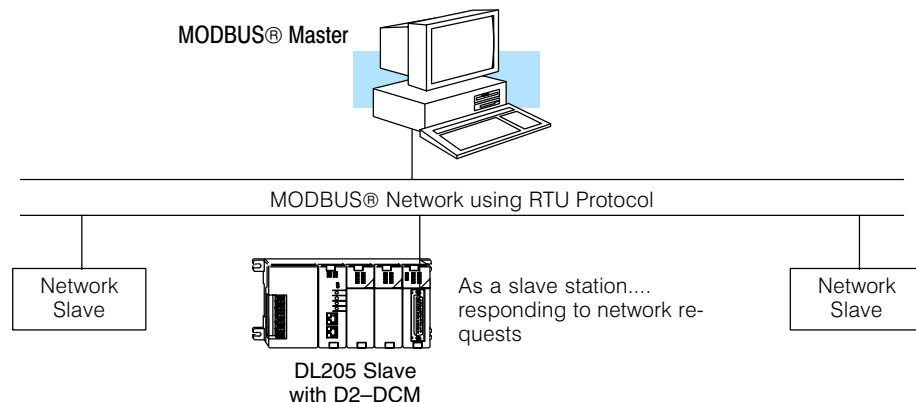

Specifications

Environmental Specifications

Operating Temperature	32° F to 131° F (0° to 55° C)
Storage Temperature	-4° F to 158° F (-20° to 80° C)
Operating Humidity	5 to 95% (non-condensing)
Air Composition	No corrosive gases permitted
Vibration	JIS C0040
Shock	JIS C0041
Voltage Isolation	1500 VAC, 1 minute duration
Insulation Resistance	10M ohms at 500 VDC
Noise	NEMA ICS3-304

Operating Specifications

Power Budget Requirement	300ma @ 5 VDC
Maximum number of modules	limited only by power budget
CPU Required	D2-240/250-1/260 minimum firmware V1.8 or later
Location of module	CPU base only any slot except Slot 0 or CPU slot
Interface	Serial RS232C / RS422 half-duplex, DTE, Asynchronous, 8 bits/character, odd or no parity
Baud Rates	300 to 38.4K baud, switch selectable
Maximum Distance	RS232C – 49ft (15 meters) RS422 – 3300 feet (1000 meters)
Protocol	DirectNET ¹ K-sequence (proprietary) MODBUS® RTU
Diagnostics	Automatic check of ROM/RAM, communications, switch settings, and LEDs

D2-240 (firmware V1.8 or later), D2-250-1 and D2-260

Note 1: Also compatible with Hostlink and/or CCM2 protocols. These names were used by previous vendors of compatible Koyo designed products.

Using your D2-DCM– Five Steps

STEP 1. Familiarize yourself with the communications options of D2-DCM in the Introduction.

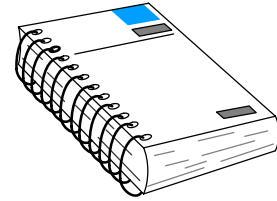

STEP 2. Build the communication cable that fits your needs.

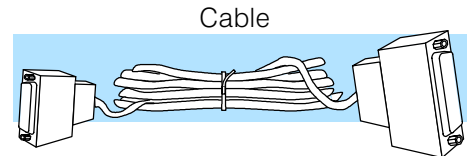

STEP 3. Set the D2-DCM switches. (Baud rate, parity, etc).

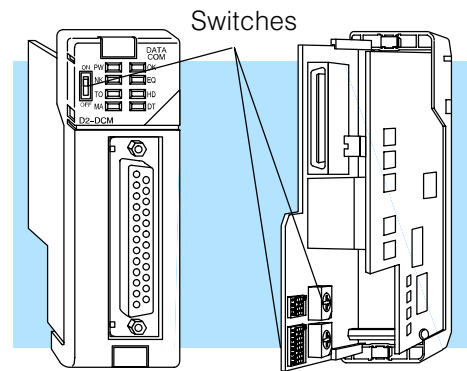

STEP 4. Install the D2-DCM in any slot except for Slot 0, which is next to the CPU.

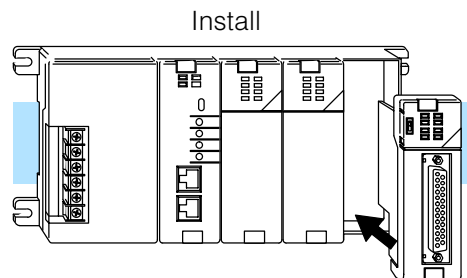

STEP 5. Verify correct network operation by using the indicators and the troubleshooting chart.

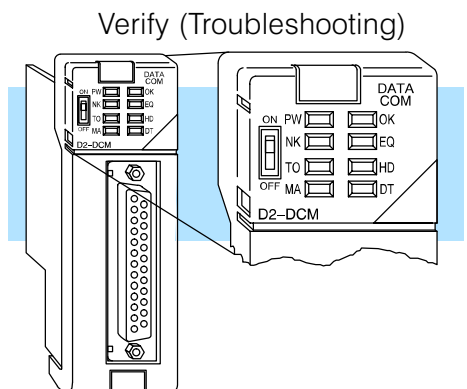

Building the Communication Cable

There are several considerations that help determine the type of cable needed for your D2–DCM application.

1. Will the D2–DCM be physically connected in a point-to-point configuration or multi-drop configuration?
2. What electrical specification is best for your application? RS232C or RS422?
3. What is the cable schematic?
4. What are the relevant cable specifications?
5. What installation guidelines are necessary?

The next few pages discuss these considerations in detail.



Tip: If you need a quick test cable you may want to try our FA–CABKIT which allows you to quickly build several different types of cables. (See page 15 for more information). If you're fairly comfortable with network or communications cabling requirements, see Appendix A for detailed diagrams.

**Consideration 1:
Physical
Configuration**

The D2-DCM can be used in either a point-to-point or multi-drop configuration. A point-to-point connection only has two stations, a master and a slave. Use the point-to-point configuration to connect a personal computer, an operator interface, or an intelligent device to a single D2-DCM. You must also use this configuration when you want to connect a *DirectNET* master station to a single *DirectNET* slave station.

Use the multi-drop configuration to connect one master to two or more slaves (90 slave maximum).

Point to Point

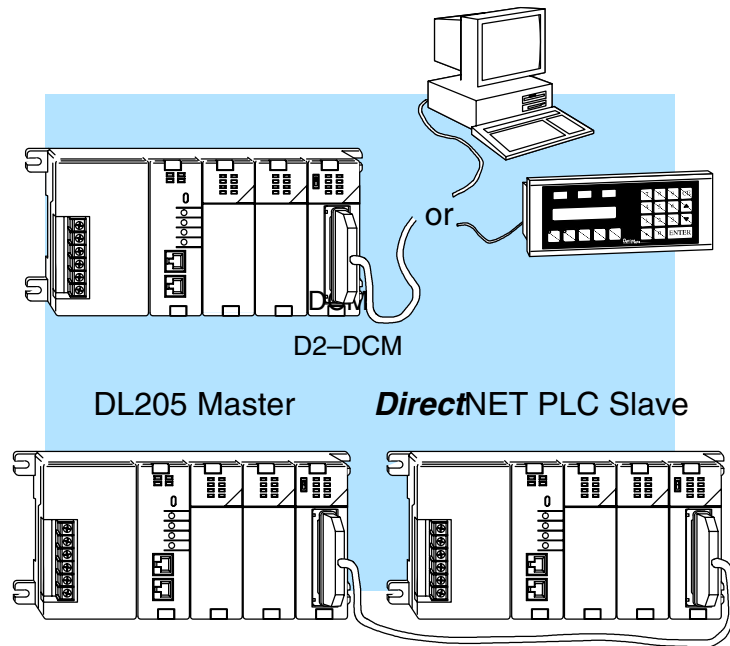

Multi-drop

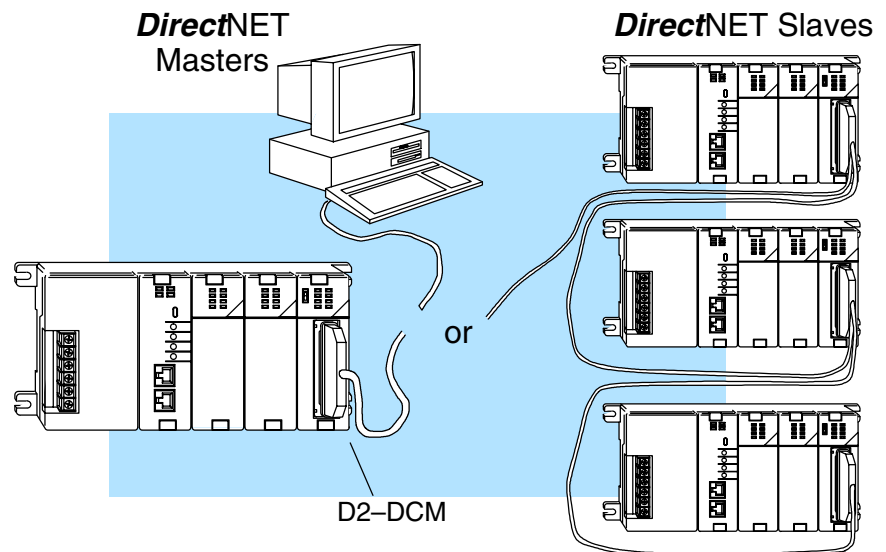

**Consideration 2:
Electrical
Specification
RS232C or RS422**

The D2-DCM can support RS232C or RS422 communication. Your application and configuration choice will help determine which electrical specification is best for you. If you are using multi-drop, you must use RS422. If you are using point-to-point, you may have a choice between RS232C and RS422.

You can use RS232C if the cable length is less than 50 feet and if the cable will not be subjected to induced electrical noise that is commonly found near welders, large motors, or other devices that create large magnetic fields.

You must use RS422 for all other applications. RS422 allows longer cable distances (up to 3300 feet) and provides higher noise immunity.

**Consideration 3:
Cable Schematics**

Although the network configuration and electrical specification are important, the type of devices being connected to the D2-DCM are just as important. The exact cable schematic needed really depends on a combination of all three things. There are a wide range of possibilities when you consider that all three product families, the DL205, DL305, and DL405 all offer **DirectNET** communication capabilities.



Hint: Look at Appendix A to determine a cable possibility. Some of these examples may need to be combined to design a cable for your application.



NOTE: If you are using the D2-DCM to connect an OptiMation operator interface, you must order our standard pre-made cable, part number OP-4CBL-2. If you are using a DV-1000, you must build a custom cable. See the cable diagram at the end of Appendix A.

The following diagram shows the port pinouts for the D2-DCM and the bottom port of the DL240 CPU. These are the two most likely combinations that you will use. Notice that the D2-DCM has two sets of RS422 pins. These pins are internally connected and can make it easier to wire multidrop connections.

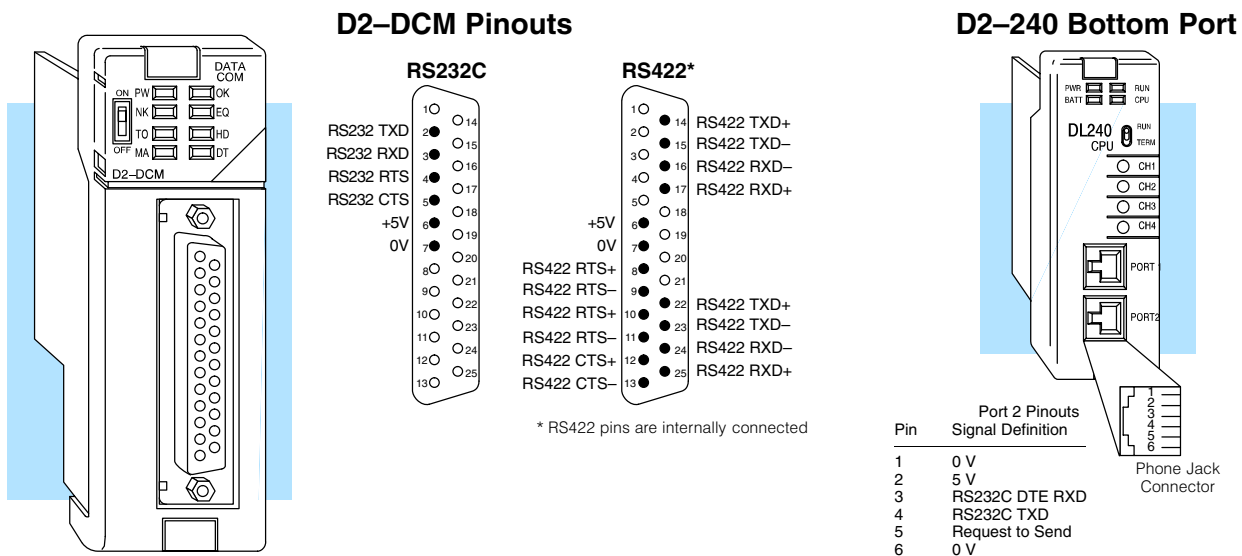

NOTE: ~~The DL205 CPU ports only support RS232C signal levels.~~ If you are going to have more than one slave station, you will have to use RS422 and a FA-UNICON RS232 to RS422 converter for each slave station. See the cable diagrams shown in Appendix A for detailed diagrams.

This note is incorrect. Only the D2-230 and D2-240 CPUs support RS232 only. D2-250(-1) and D2-260 CPUs support RS232/422/485 without extra hardware.

Consideration 4: Cable Specifications

Change this cable reference to "AutomationDirect L19772-1 (Belden 8102) or equivalent".

Although many types of cables may work for your application, we recommend you use a cable that is constructed to offer a high degree of noise immunity. A cable constructed equivalent to **Belden 9855** is sufficient. The following specifications are to be used as a guideline. ↑

Structure	Shielded, twisted-pair (RS232C only uses two wires and a ground)
Conductor size	24 AWG or larger
Insulation	Polyethylene
Shield	Copper braid or aluminum foil
Impedance	100Ω @ 1MHz
Capacitance	60pf / meter or less

Consideration 5: Installation Guidelines

Your company may have guidelines for cable installation. If so, you must check those before you begin the installation. Here are some general things to consider.

- Don't run cable next to larger motors, high current switches, or transformers. This may cause noise problems.
- Route the cable through an approved cable housing to minimize the risk of accidental cable damage. Check local and national codes to choose the correct method for your application.
- Consider redundant cabling if the application data is critical. This allows you to quickly reconnect all stations while the primary cable is being repaired.

Cable Shield Grounding — It is important to ground the cable shield to minimize the possibility of noise. The preferred method is to connect one end of the cable shield to the connector housing. If noise problems are still present and you have a good earth ground for the cabinet, you must connect one end of the shield to the cabinet earth ground. *Don't* ground both ends of the shield because this will create induced noise on the cable.

Step 1: Strip back about 2.5" of the shield.

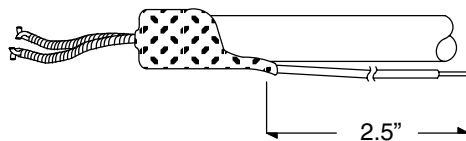

Step 2: Crimp a ring connector onto the shield.

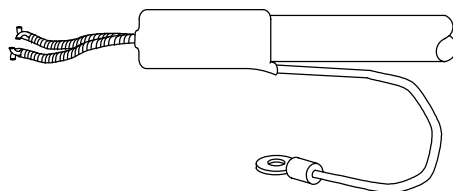

Step 3: Secure the shield to the connector shell.

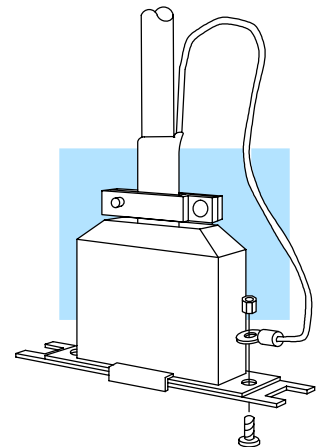

Change this sentence to:
 "For example, AutomationDirect L19772-1 (Belden 8102) or equivalent has a nominal characteristic impedance of 100 Ohms."

Multi-drop Termination Resistors — It is important you add termination resistors at each end of the RS422 line. This helps reduce data errors during data transmission. You must select resistors that match the cable impedance. For example, a typical 22 AWG solid conductor cable with 4.5 twists per foot has a typical impedance of about 120 ohm.

There are two ways to actually connect the resistors.

- Line-to-Line — this method balances the receive data lines (IN+ and IN-) and requires one resistor at each end of the line. (The cable diagrams we've provided show this method, but you can use either).
- Line-to-Ground — this method also balances the receive data lines, but common mode noise rejection is improved significantly. This method requires two resistors at each end of the line. Also, since there are two resistors, the sum total of both resistors must match the cable impedance.

The following diagram illustrates the two options.

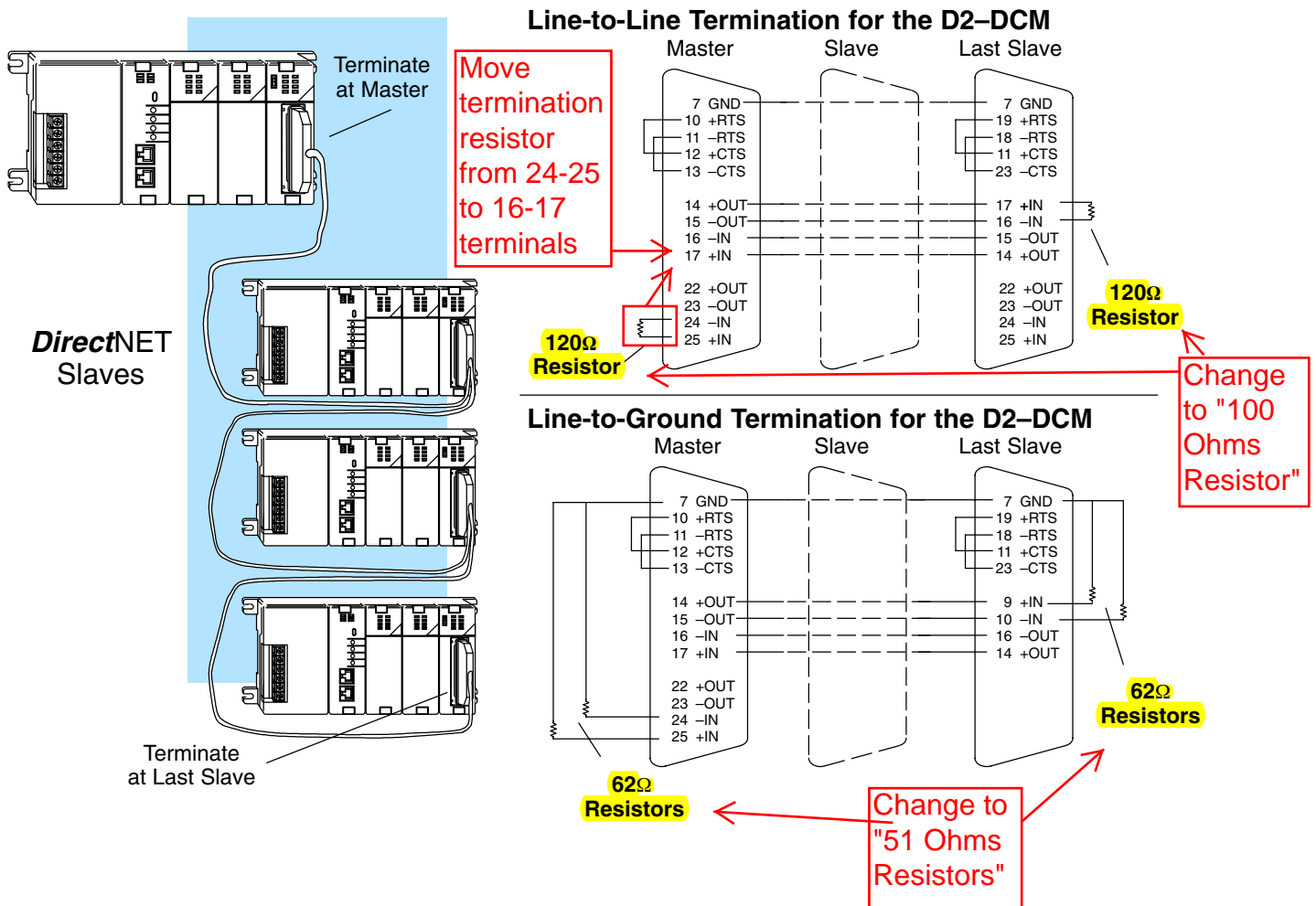

Network Amplifiers — If you have more than 16 slave stations, you must use an RS422 amplifier to maintain the signal levels. The best amplifiers are regenerative, that is, they try to improve signal quality by reducing any noise signals that are present. (They amplify the signal and not the noise if possible.) Some amplifiers are not regenerative and amplify the noise as well as the signal. You can purchase amplifiers from several sources. The Black Box catalog is one of many good places to start; they sell direct. Call 1-800-555-1212 and ask the 800 directory assistance operator for their phone number. You can also look for an amplifier supplier on the internet. One web site to look at is www.idealsolution.com, or search for other RS422 amplifier web sites. The following diagram illustrates some instances where an amplifier is necessary.

Serial Slave Connection

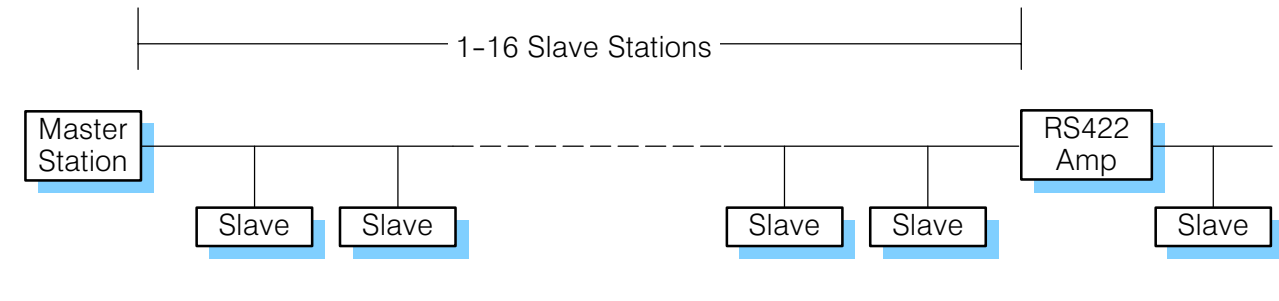

Parallel Slave Connection

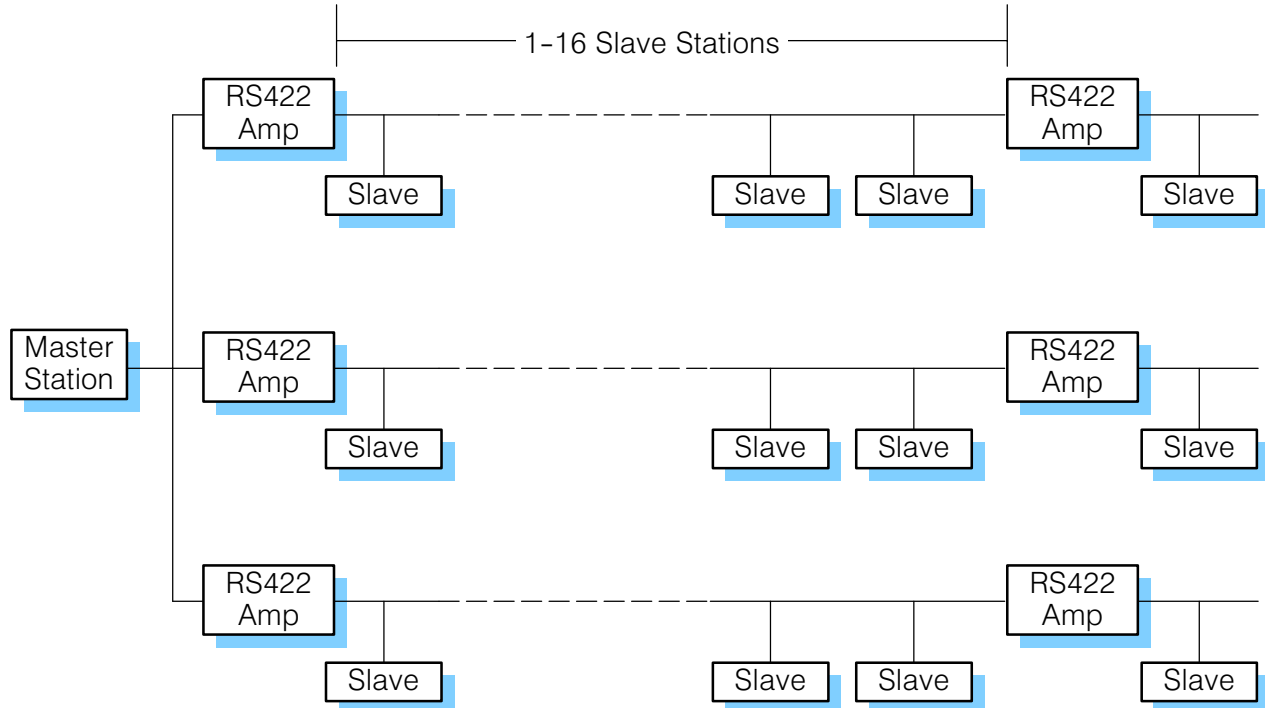

A Quick Test Cable

AutomationDirect offers a Universal Cable Kit (part number FA-CABKIT). This cable kit allows you to connect various types of **DirectLOGIC** products with an RS232C cable. The kit consists of cable (phone cable with male plugs already attached) and several specially wired connectors. The special connectors are a D-sub style with built-in female phone jacks. The kit includes a wide variety of the special connectors so you can use one kit to connect products from the different **DirectLOGIC** family of products. To use the kit with the D2-DCM, just follow these steps.

1. Plug the appropriate D-sub connector onto the D2-DCM.
2. Plug the appropriate D-sub connector onto the other device you are connecting to the D2-DCM.
3. Connect the cable to the two D-sub connectors.



WARNING: This cable is suitable for quick testing situations and must not be used in actual applications. This cable is not shielded and is highly susceptible to electrical noise. Electrical noise can cause unpredictable operation that may result in a risk of personal injury or damage to equipment. Use the cable specifications described earlier in this manual to select a cable suitable for actual applications.

Build A Test Cable In 30 Seconds

1. Attach Universal Cable Adapter to the D2-DCM
2. Attach another Universal Cable Adapter to the Device which will connect to the D2-DCM
3. Attach the Universal Cable

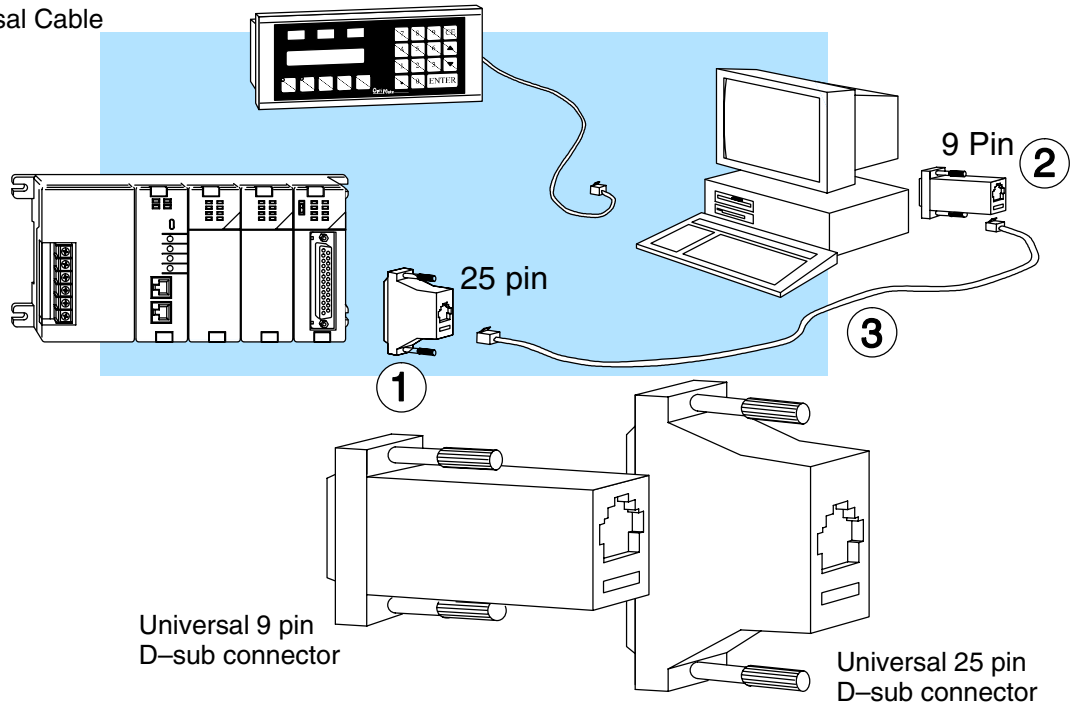

Cable Kit Contains one (1) each of:

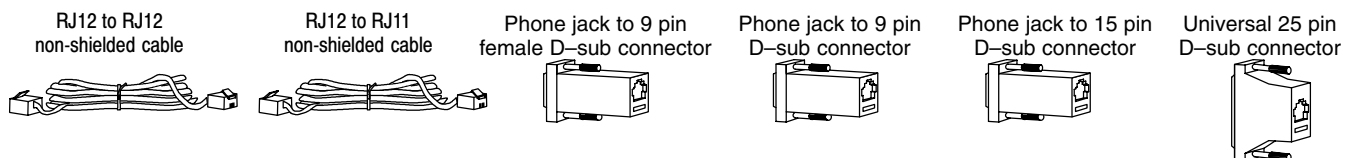

Setting the D2-DCM switches

The D2-DCM has two banks of dipswitches that allow you to select the communication parameters necessary for your application. In quite a few cases, you may not have to change the switches at all. The D2-DCM comes set from the factory for:

- **DirectNET** Slave operation
- 9600 Baud
- Station Address 1
- Odd Parity
- Hex Mode

Host Computer or Operator Interface Connection

If you're using a host computer or operator interface as the master station you should set the D2-DCM to match the master station parameters. Check the documentation that came with your computer or operator interface panel to determine the available communication parameters.

You'll need to know the following things.

- Baud rate
- Parity settings
- Protocol required

Your operator interface must use one of the following protocols.

- **DirectNET**
- K-sequence
- Hostlink (**DirectNET** was called Hostlink on the old TI™ or Simatic® TI products. Some Operator Interface manufacturers may still refer to it this way.)
- MODBUS® RTU

DirectNET Interface Connection

If you're using the D2-DCM as a **DirectNET** interface, you'll need to know whether the D2-DCM is being used in a master station, slave station, or peer station. Once you've determined how the D2-DCM will be used, proceed with the dipswitch settings.

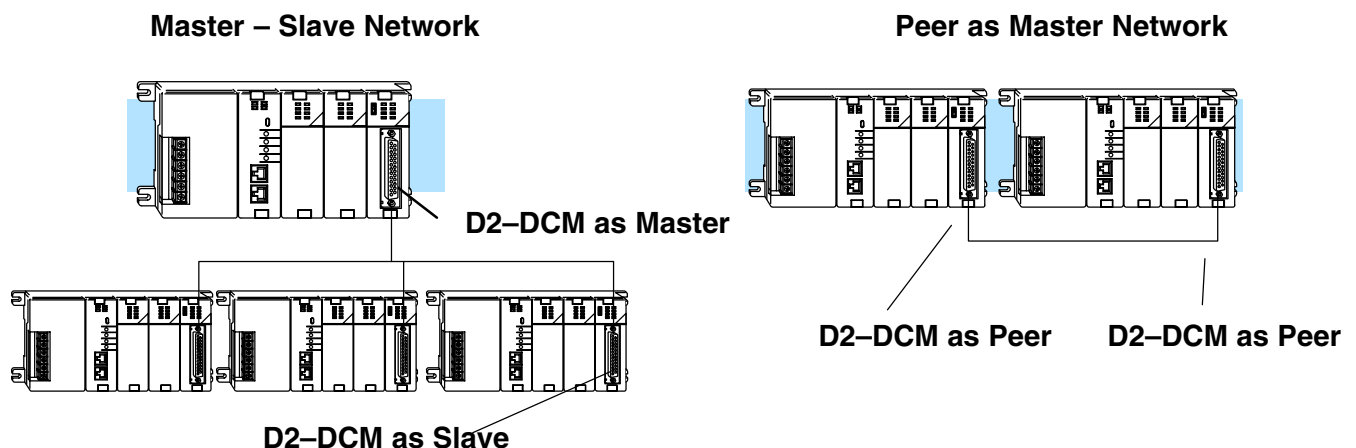

**D2-DCM
Switch Settings**

Once again, the switches should be set at the factory for the following type of operation.

- **DirectNET Slave**
- 9600 Baud
- Station Address 1
- Odd Parity
- Hex Mode

NOTE: Although it is not listed in the switch settings, K-sequence is also available whenever the D2-DCM is set for DirectNET Slave operation.

If these settings are acceptable, then you can go ahead and install the D2-DCM into the base. If not, you'll have to change the switch settings.

There are two small banks of switches located next to the blue rotary switches on the one of the D2-DCM circuit boards. These dipswitches are used to select the communications settings. The following diagram shows the switch locations and their purpose.

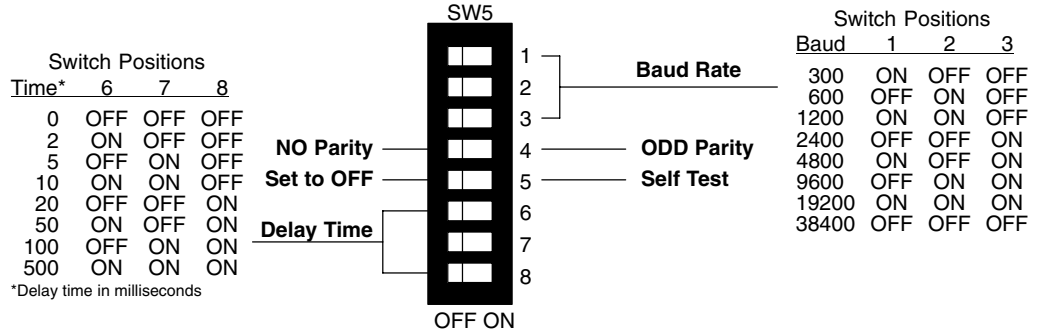
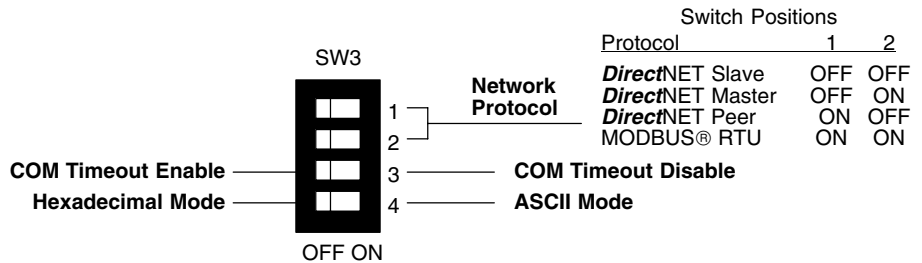
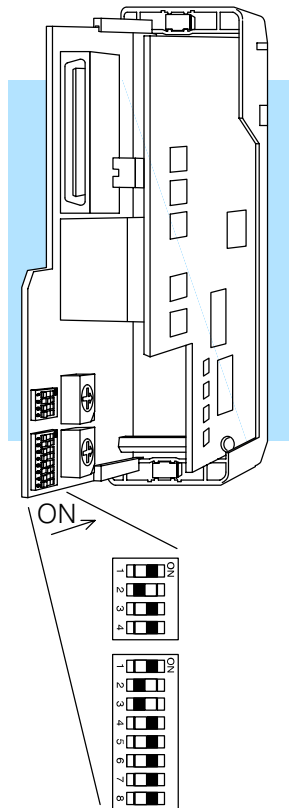

Protocol Selection: Positions 1 and 2 on SW3 select the D2–DCM protocol and the master or slave settings. The D2–DCM primarily uses two protocols, **DirectNET** and MODBUS® RTU protocol. Here's some information to help you choose.

Communications Port for DirectSOFT32 Programming: If you plan to program the CPU through the D2–DCM, then you can use either **DirectNET** protocol or our proprietary protocol, called K-sequence. Although it is not listed in the switch settings, K-sequence is also available whenever the D2–DCM is set for **DirectNET** slave operation.

Computer or Operator Interface: If you're using the D2–DCM to connect a computer or operator interface, check your documentation to see which protocol is being used. Since the D2–DCM is always a slave station when it's connected to a computer or operator interface, you should select **DirectNET** slave or MODBUS® RTU slave. Note, there are also a handful of operator interfaces that have been designed to use our proprietary K-sequence protocol. If you have one of these, or if you need to use K-sequence for some reason, make sure you set the D2–DCM for **DirectNET** Slave operation. Peer to Peer works in Hexadecimal mode only.

DirectNET Master / Slave: In a **DirectNET** master / slave network, one D2–DCM should be set as a master and the rest should be set as slaves.

DirectNET Peer as Master: This is a variation of the master / slave protocol and should be selected when you only have two stations that can each initiate requests. Each station must have a D2–DCM as the network interface.

MODBUS® RTU Slave: The D2–DCM can also be a MODBUS® slave (in the RTU or HEX mode). The D2–DCM cannot be a MODBUS® master station. If you're going to use MODBUS®, make sure your software package supports the DL205 products. See Appendix C for more information.

Communication Timeout: Position 3 on SW3 selects the communication timeout. For most cases, you should leave this switch in the OFF position. Communication Timeout Disable is normally used *only* if you're developing your own **DirectNET** programs. By disabling the timeout, you can send one **DirectNET** component without any communication timeout problems. If you have this timeout disabled and a communication error does occur, you must restart communications by sending a retry or an End of Transmission (EOT) command. If you want to know more, see the **DirectNET** manual for details.

ASCII / HEX Mode: Position 4 on SW3 selects between ASCII and HEX modes of data representation. If you want the fastest communication possible, use HEX mode, which is the default. The difference is in the way the data is represented. The same data is twice as long in ASCII format, so if there's more data, it takes longer to transfer. If you have a device on the network that requires ASCII mode, then set the switch for ASCII mode, otherwise, use HEX mode.

Baud Rate: Positions 1 – 3 on SW5 are used to set the baud rate for the D2–DCM. There are eight baud rate selections available ranging from 300bps to 38.4Kbps. **All stations must have the same baud rate before the communications will operate correctly.** Usually, you should use the highest baud rate possible unless noise problems appear. If noise problems appear, try reducing the baud rates.

Parity: Position 4 on SW5 selects between the two parity options, odd or none. If you're using all DL205 equipment, you should use odd parity. Odd parity uses eleven bits total (1 start bit, 8 data bits, 1 stop bit, and 1 parity bit).

Some devices require no parity, which uses only 10 bits (1 start bit, 8 data bits, and 1 stop bit).

Self-Test: Position 5 on SW5 selects the factory self-test and should always be switched off. If the self-test is on, the module will not operate correctly.

Response Delay Time: Positions 6–8 on **SW4** set the response delay time. The delay time specifies the amount of time the D2–DCM waits to send the data after it has raised the RTS signal line. This is normally set to 0, and is typically only adjusted if you are using the D2–DCM with a radio modem. If you are using the D2–DCM with a radio modem, check your modem documentation to help you choose the proper setting. Also, if you're considering the use of a modem, check out Appendix D. It may be of some help.

SW4 is incorrect. It should be SW5. (SW4 is used for firmware updates.)

Address Selection Switch

The D2–DCM station address is set by the two rotary switches located on one of the D2–DCM's circuit boards. **Addresses are in hexadecimal format with valid addresses from 0 (only used for the master station) to hexadecimal 5A.** The addresses do not have to be consecutive, but each station must have a unique address.

The top rotary switch is used to set the most significant digit of the HEX address. The bottom switch is used to set the least significant digit of the HEX address. For example, to set a D2–DCM address of HEX 10 (decimal 16), set the top rotary switch to 1 and the bottom rotary switch to 0. If you're using the D2–DCM as a master, make sure you select address 0.

Even though the D2–DCM address is set in hexadecimal, it's a good idea to remember the decimal equivalent. This is because the decimal address is used most often. For example, a RLL communications program, the *DirectSOFT32* Programming Software, and our DSData Server all use the decimal equivalent of the HEX address. It's easy to convert from hex to decimal.

Example: Switches set for 3C

HEX Format

0	1	2	3	4	5	6	7	8	9	A	B	C	D	E	F
										10	11	12	13	14	15

HEX 3C

$$3 \times 16 = 48 \quad + \quad C = 12 \quad = 60 \text{ decimal}$$

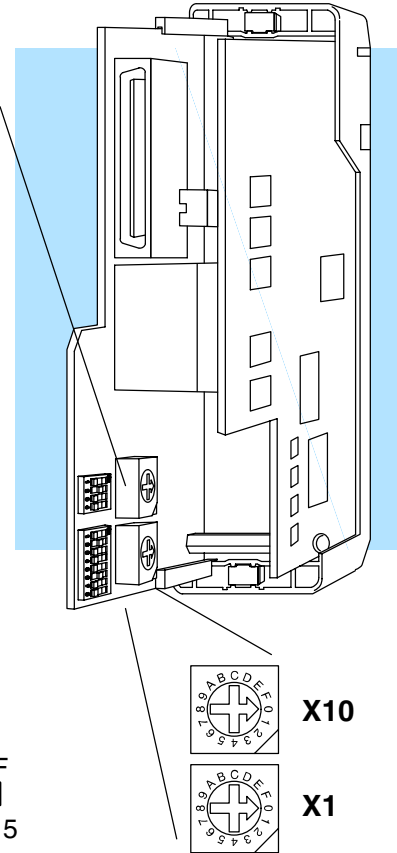

Warning: The D2–DCM address switch settings are only read at power up. If you want to change the address, you must remove the module from the base to access the switches. Your system can be damaged if you install or remove system components before disconnecting the system power. To minimize the risk of equipment damage, electrical shock, or personal injury, always disconnect the system power before installing or removing any system component.

**Online / Offline
Switch**

On the front of the unit, just to the left of the LEDs, you'll notice a small slide switch. This switch is labeled ON (for online) and OFF (for offline). If you want to communicate through the D2-DCM, make sure this switch is in the ON position.

In the OFF position, this switch logically disconnects the D2-DCM from the network (just as if you pulled the cable from the connector). Once this switch is moved to the OFF position, the D2-DCM will not communicate with the network. If you move the switch to the ON position, the D2-DCM will communicate with the network, but not until the master sends another request for communication. This does not operate like the reset switch on many personal computers.

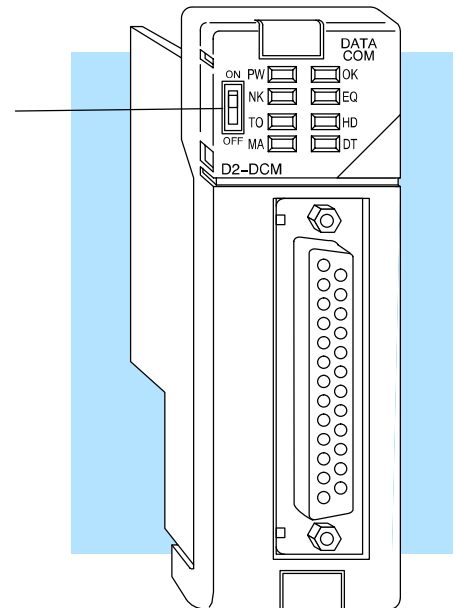

Install the D2-DCM and Starting the Network

Install the D2-DCM The D2-DCM can go in any slot of a DL205 base **except** Slot 0, which is right next to the CPU. The D2-DCM will not work in Slot 0.

If you're using a D2-DCM as the network interface in a PLC master station, remember to make a note of the slot location. (You will have to refer to this address at some point.)



NOTE: The D2-DCM *can not* be mounted in a base that does not contain a D2-240/250-1/260 CPU. Also, the D2-DCM requires 300mA of +5V base power. Make sure you will not exceed the available base power budget by installing the D2-DCM. See the DL205 User Manual for complete details on power budget calculations.

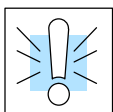

WARNING: Your system can be damaged if you install or remove system components before disconnecting the system power. To minimize the risk of equipment damage, electrical shock, or personal injury, always disconnect the system power before installing or removing any system component.

To insert the module into the base, align the circuit board(s) with the grooves on the top and bottom of the base. Push the module straight into the base until it is firmly seated in the backplane connector. Once the module is inserted into the base, push in the retaining clips (located at the top and bottom of the module) to firmly secure the module to the base.

D3-DCM cannot be mounted in the farthest slot from the CPU in a base. It requires 300 mA of +9 V base power. Make sure you will not exceed the available base power budget by installing the D3-DCM. See the DL305 User Manual for complete details on power budget calculations."

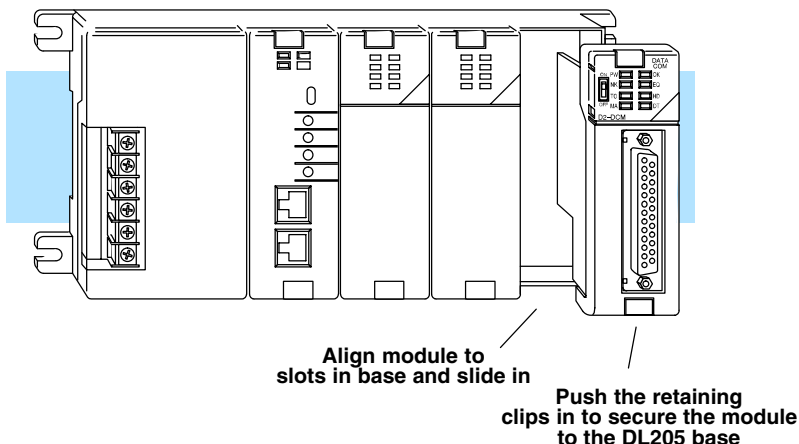

Connect the Cables Make sure you have all the cables connected and that all the network devices have the same communication parameters (baud rate, parity, etc).

If you're using DirectNET...

The PLC master station must contain an RLL program that has the appropriate RX and WX instructions necessary to initiate the communications. (See Appendix B for details on the RX and WX instructions). The master station CPU must be in Run mode in order to execute the communications program. The slave station CPUs do not absolutely have to be in Run mode because the D2-DCM will still transfer the data. Whether you put the slave stations in Run mode depends on your application requirements.

If you're using an Operator Interface or Host Computer...

Connect the cables and follow the procedures outlined in the documentation that came with your host computer software or operator interface. You'll have to execute your host or operator interface program before the communications can begin. For example, if you're using *DirectSOFT32*, you can just specify the station address and start working!

If you're using MODBUS®...

Connect the cables and follow the procedures outlined in your MODBUS® Host software package to start the communications. See Appendix C for more information on using the D2-DCM with MODBUS protocol.

Verification and Troubleshooting

If you have used the guidelines shown previously in Step 3, Starting the Network, you are now ready to verify that the unit is operating properly. Check the D2-DCM indicators to verify the D2-DCM is operating correctly. The following diagram shows the proper indicator conditions.

Note: Online/Offline switch has been removed from the drawing for clarity.

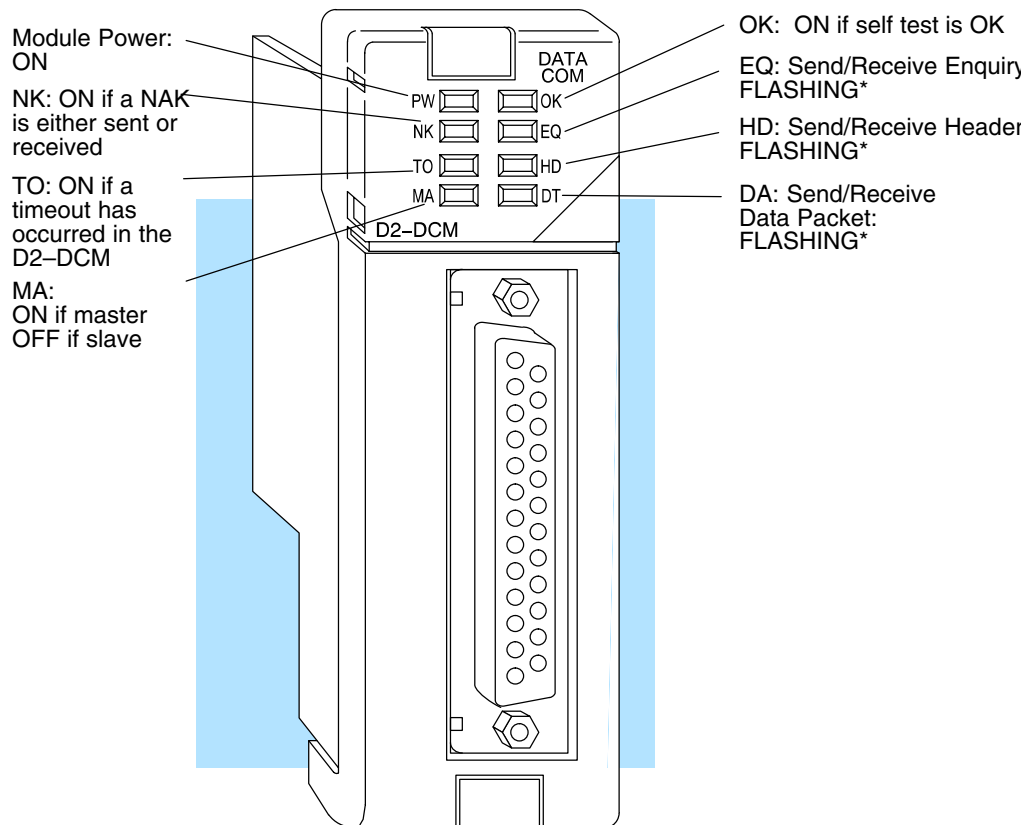

* During Communication only

**Troubleshooting
Quick Steps**

If the D2–DCM does not seem to be working correctly, check the following items. These items represent the problems found most often.

1. Cable and connections. Incorrectly wired cables and loose connectors cause the majority of problems. Verify you've selected the proper cable configuration and check the cable making sure it is wired correctly.
2. Dipswitch settings. Make sure you've set the D2–DCM to match the communication parameters required by the master station (D2–DCM, operator interface or host computer).
3. Incorrect protocol. Make sure your operator interface or personal computer software can use the **DirectNET**, Hostlink, CCM2, or MODBUS® RTU protocol.
4. Communications program. Check the communications program for errors. Consult the **DirectNET** Manual or the manuals that came with your host computer software or operator interface for details.































































































































































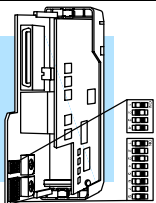

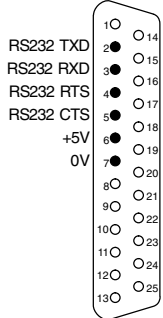
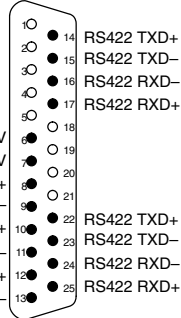





NOTE: If you need more in depth troubleshooting, see the chart on the next page. It provides several different indicator patterns that may help identify your exact problem.

Troubleshooting Chart

The following chart identifies the indicator status, possible cause, and corrective action for a wide variety of commonly found problems.



Master Station Indicators	Slave Station Indicators	Possible Cause
PW  OK  NK  EQ  TO  HD  MA  DT 	PW  OK  NK  EQ  TO  HD  MA  DT 	1. Master PLC power is disconnected 2. D2-DCM is defective
PW  OK  NK  EQ  TO  HD  MA  DT 	PW  OK  NK  EQ  TO  HD  MA  DT 	1. Switch setting on master station is incorrect
PW  OK  NK  EQ  TO  HD  MA  DT 	PW  OK  NK  EQ  TO  HD  MA  DT 	1. The master station CPU not in RUN. 2. Online/Offline switch is set to OFF. 3. Communications program is not correct.
PW  OK  NK  EQ  TO  HD  MA  DT 	PW  OK  NK  EQ  TO  HD  MA  DT 	1. COM Timeout is disabled. 2. RTS and CTS signals are not looped back on the D2-DCM end of the cable.
PW  OK  NK  EQ  TO  HD  MA  DT 	PW  OK  NK  EQ  TO  HD  MA  DT  Only PW and OK OR EQ flashes.	1. RLL Communications program is incorrect. 2. Settings are different. 3. Cable problem.
PW  OK  NK  EQ  TO  HD  MA  DT 	PW  OK  NK  EQ  TO  HD  MA  DT  EQ & NK come on OR EQ and HD flash.	1. Settings are different. 2. Cable problem or Slave is offline.
PW  OK  NK  EQ  TO  HD  MA  DT 	PW  OK  NK  EQ  TO  HD  MA  DT  EQ & HD come on	1. Settings are different.
PW  OK  NK  EQ  TO  HD  MA  DT 	PW  OK  NK  EQ  TO  HD  MA  DT  EQ & HD come on THEN EQ goes off, HD and NK are on	1. RLL Communications program is incorrect. 2. Settings are different.
PW  OK  NK  EQ  TO  HD  MA  DT 	PW  OK  NK  EQ  TO  HD  MA  DT 	1. Electrical noise.

Corrective Action	Switch Settings & Port Pinouts
<p> 1. Check the master PLC source power.</p> <p> 2. Replace the D2-DCM.</p>	<div style="text-align: center;"> <h3>Switch Settings</h3>  <p>SW3</p> <p>1 — Network Protocol</p> <p>2 — COM Timeout Enable</p> <p>3 — COM Timeout Disable</p> <p>4 — ASCII Mode</p> <p>OFF ON</p> </div> <div style="text-align: center;">  <p>SW5</p> <p>1 — Baud Rate</p> <p>2 — NO Parity</p> <p>3 — Set to OFF</p> <p>4 — ODD Parity</p> <p>5 — Self Test</p> <p>6 — Delay Time</p> <p>7 —</p> <p>8 —</p> <p>OFF ON</p> </div> <div style="margin-top: 20px;"> <h3>Port Pinouts</h3> <div style="display: flex; justify-content: space-around;"> <div style="text-align: center;"> <p>RS232C</p>  </div> <div style="text-align: center;"> <p>RS422*</p>  </div> </div> <p style="text-align: right; font-size: small;">* RS422 pins are internally connected</p> </div>
<p> 1. Disconnect the master station PLC power, remove the D2-DCM and check positions 1 & 2 on SW3.</p>	
<p> 1. Place the CPU in RUN mode.</p> <p> 2. Set the switch to the ON position.</p> <p> 3. Make sure the RX or WX instruction is being executed. Check the address, slot number, and amount and type of data used in the RX/WX instructions.</p>	
<p> 1. Disconnect the PLC power, remove the D2-DCM and check position 3 on SW3.</p> <p> 2. Remove master station connector, ensure that RTS & CTS are connected according to the cable diagram.</p>	
<p> 1. Check the address, slot number, and amount and type of data used in the RX/WX instructions.</p> <p> 2. Make sure baud rate, parity, and mode (HEX/ASCII) match between the master and slave.</p> <p> 3. Verify that the cable is wired properly.</p>	
<p> 1. Make sure baud rate, parity, and mode (HEX/ASCII) match between the master and slave.</p> <p> 2. Verify that the cable is wired properly. Also, make sure slave is online.</p>	
<p> 1. Make sure baud rate, parity, and mode (HEX/ASCII) match between the master and slave.</p>	
<p> 1. Check the amount and type of data being transferred. (Byte count may be set to 1 or an odd number for a data type that requires 2 bytes.)</p> <p> 2. Make sure baud rate, parity, and mode (HEX/ASCII) match between the master and slave.</p>	
<p> 1. Make sure the system has good earth grounds. Only one end of the cable shield must be grounded.</p> <p> 2. If you're using RS232C, try RS422.</p>	

Cable Diagrams

Point-to-Point RS232C D2-DCM as Master

These diagrams show the D2-DCM being used as the network master. The cable diagram is the same when the D2-DCM is being used as a slave (for those connections that could have the master/slave roles reversed). This is true for the:

- D2-DCM to D4-DCM connection
- D2-DCM to DL305 CPU with RS232C DCU (or a D3-340 bottom port)
- D2-DCM to DL405 CPU connection when used with a D4-450 CPU.

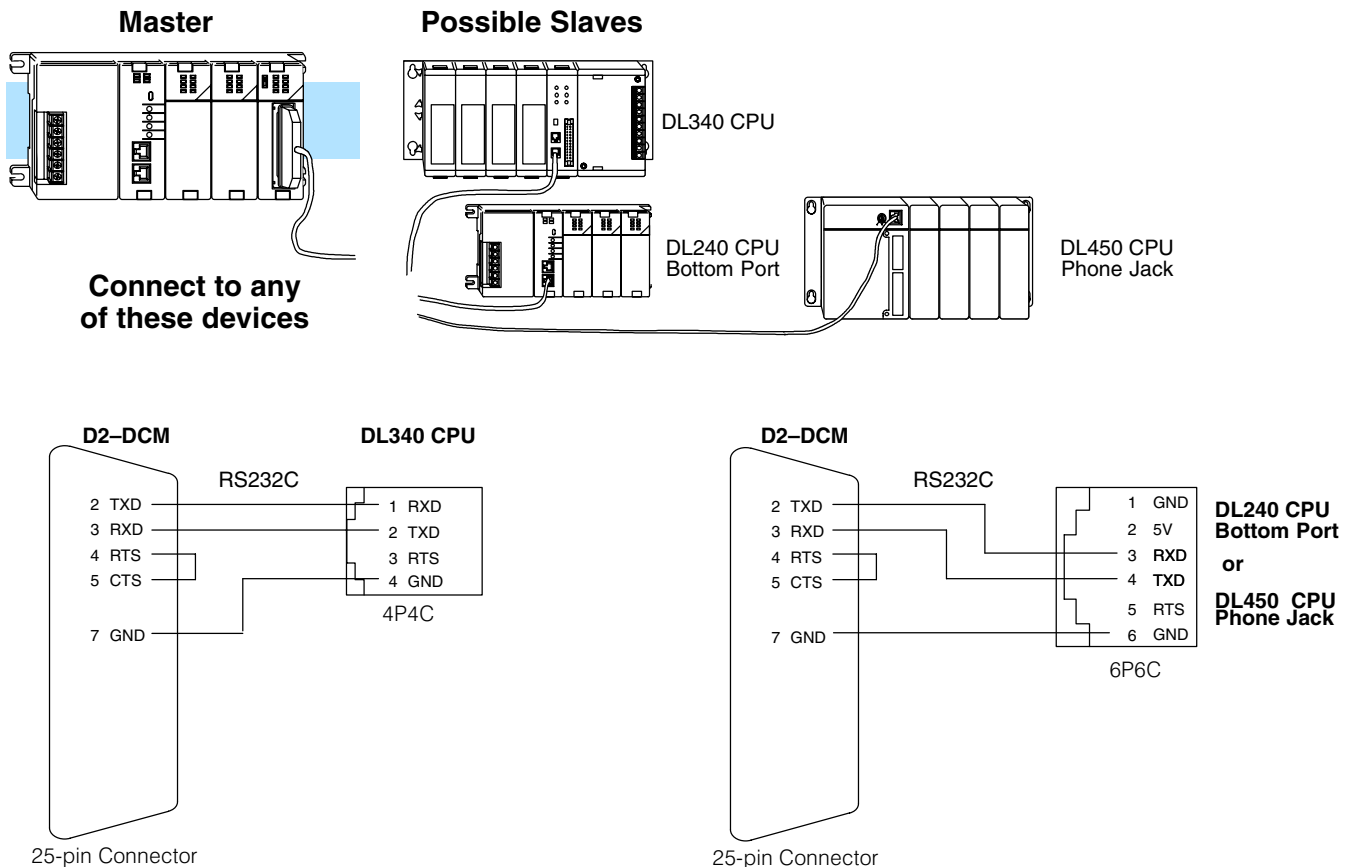
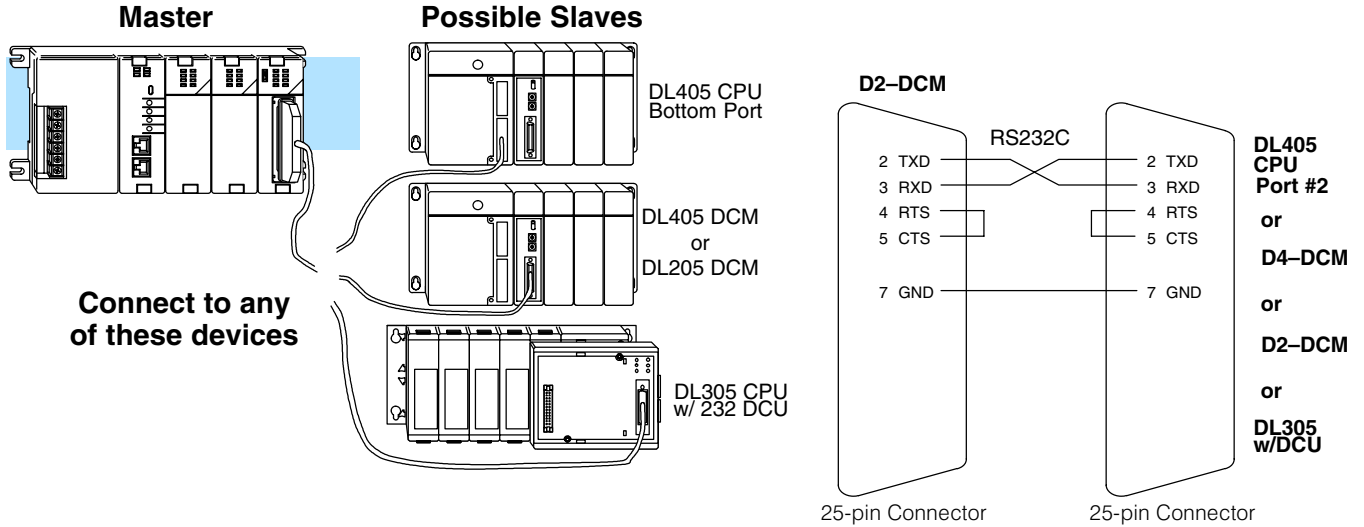

**Point-to-Point
RS232C
PC as Master**

These diagrams show the D2-DCM being used as a slave to a personal computer. The personal computer would have to be capable of issuing commands using either *DirectNET* or MODBUS RTU protocol. A good example of this would be a personal computer running an Excel spreadsheet connected through our DSData Server. (Sounds complicated, but it's really quite simple! Check out our catalog for more information on our powerful DSData Server.)

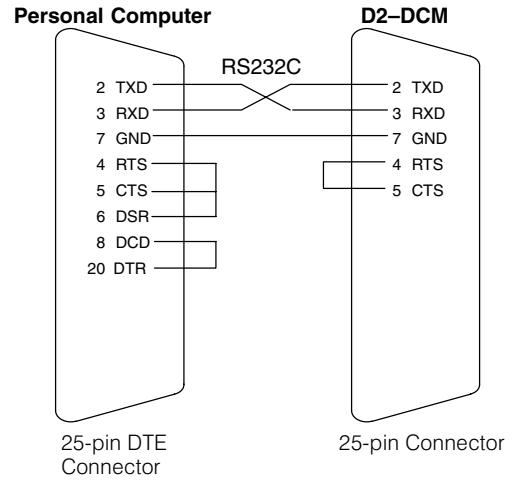
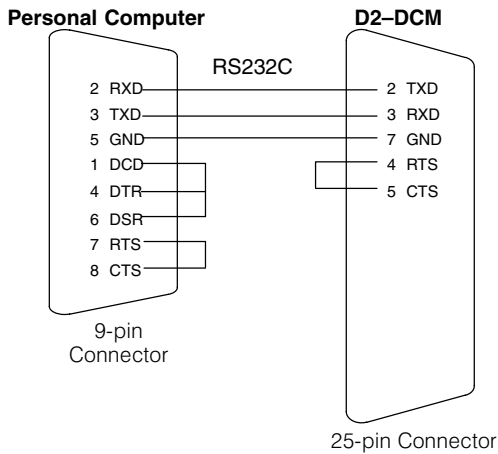
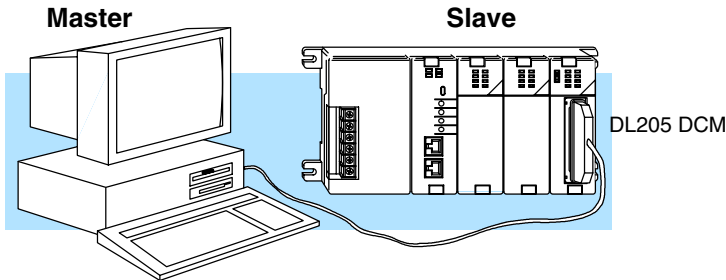

Point-to-Point RS422 D2-DCM as Master

These diagrams show the D2-DCM being used as the network master. The cable diagram is the same when the D2-DCM is being used as a slave (for those connections that could have the master/slave roles reversed). This is true for the:

- D2-DCM to D4-DCM connection
- D2-DCM to DL405 CPU connection when used with a D4-450

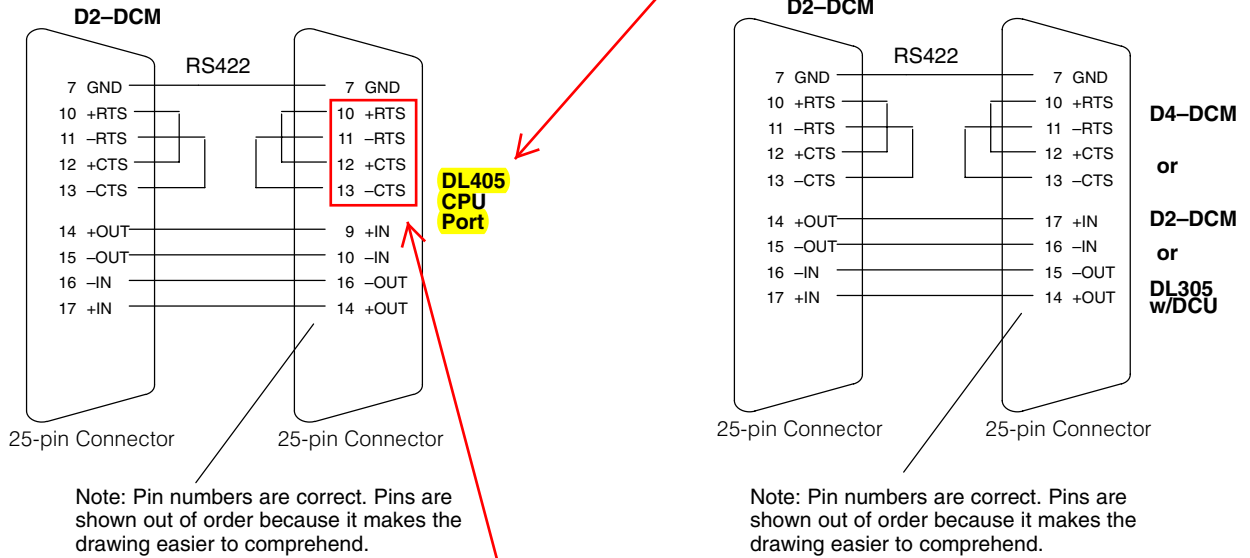
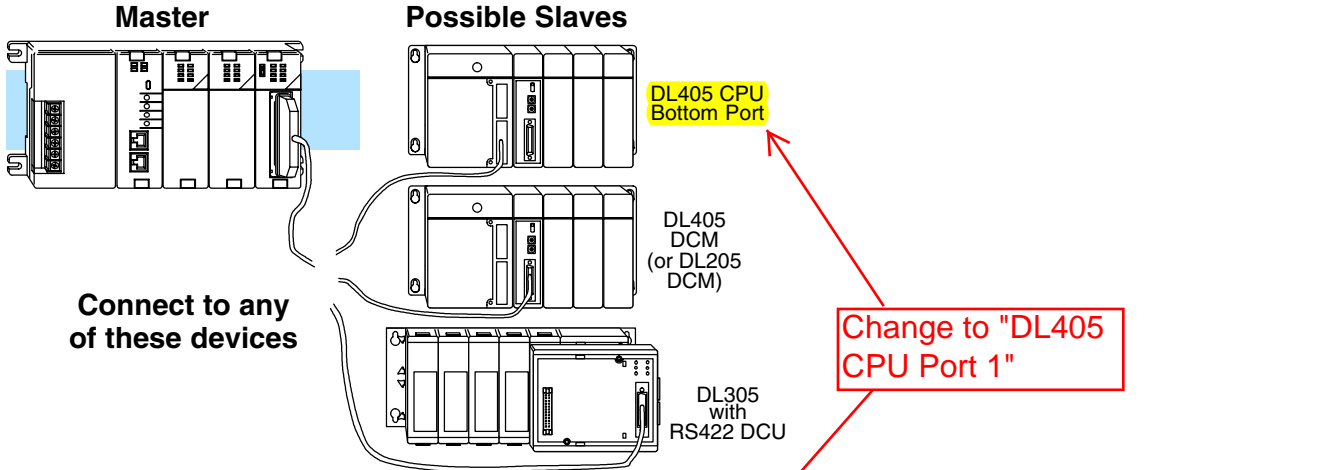

These pin numbers are incorrect. They should be:

- 19 +RTS
- 18 -RTS
- 11 +CTS
- 23 -CTS

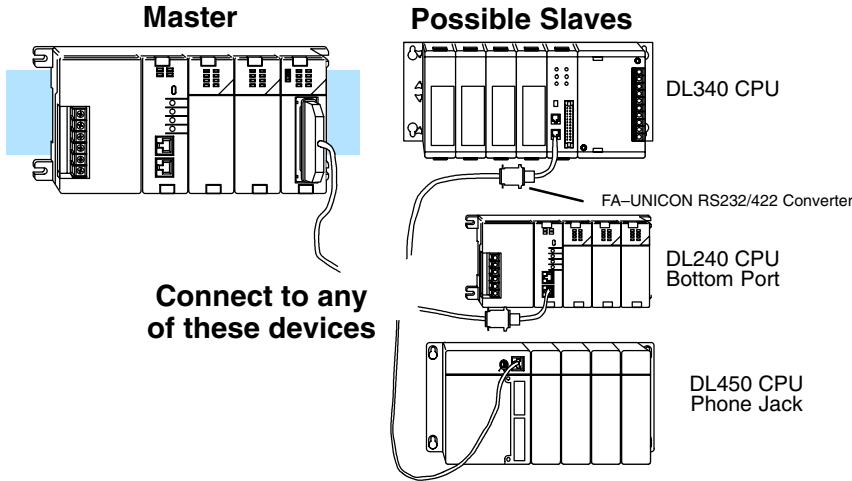

Slave Connection

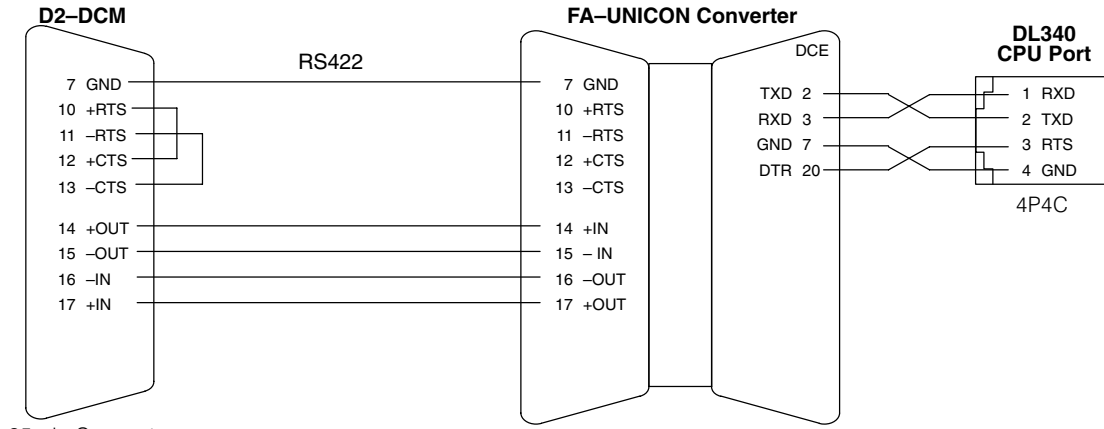

Note: RTS/CTS are looped back internally

Slave Connection

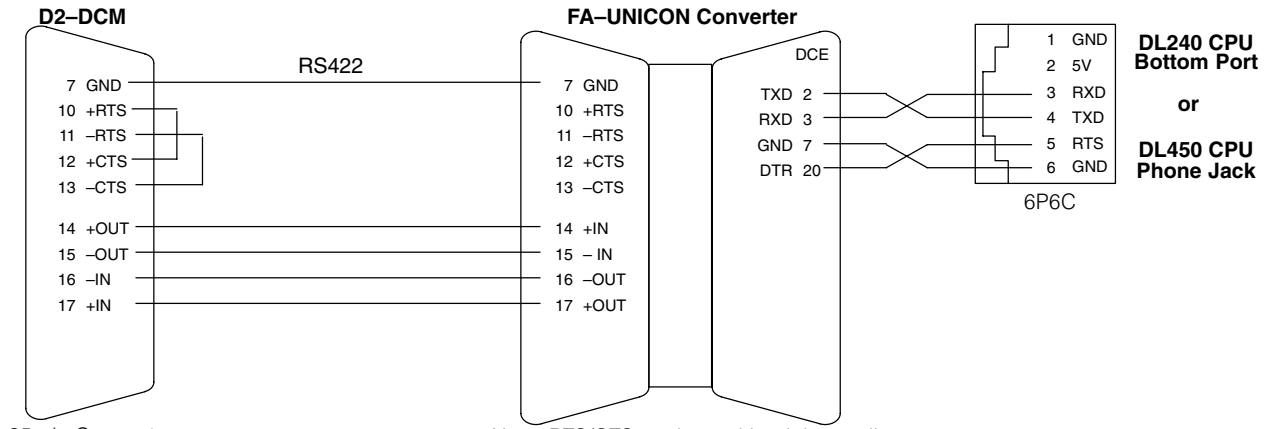

Note: RTS/CTS are looped back internally

Point-to-Point RS422 PC as Master

These diagrams show the D2-DCM being used as a slave to a personal computer. Since most personal computers come with RS232C communication cards, we have shown an FA-UNICON RS232/422 Converter being used to convert the signal. The personal computer would have to be capable of issuing commands using either **DirectNET** or MODBUS RTU protocol.

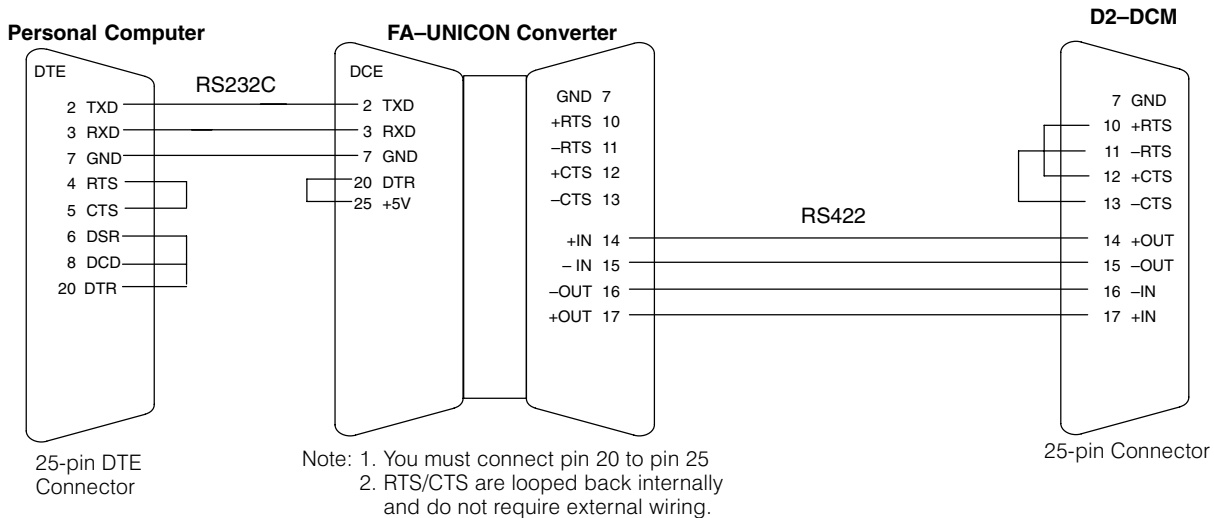
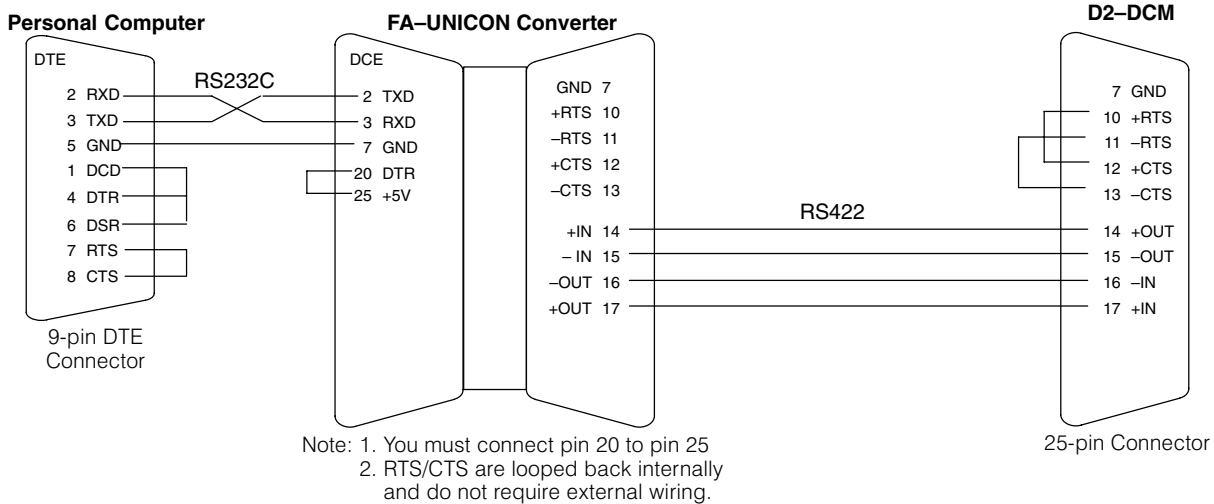
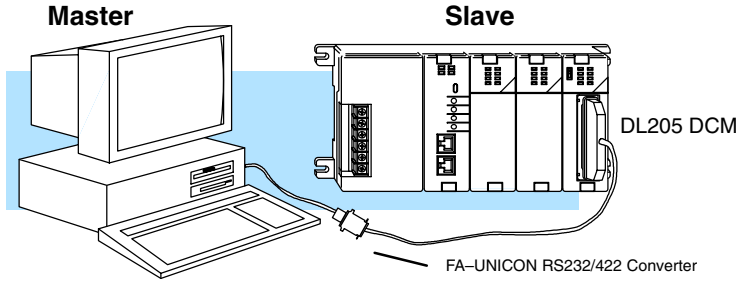

See Errata Sheet at the beginning of this file.
Both wiring diagrams below were revised.

Multidrop
RS422
D2-DCM as Master

These diagrams show the D2-DCM being used as the network master for a network consisting of various PLC stations using D2-DCMs, CPU ports, etc..

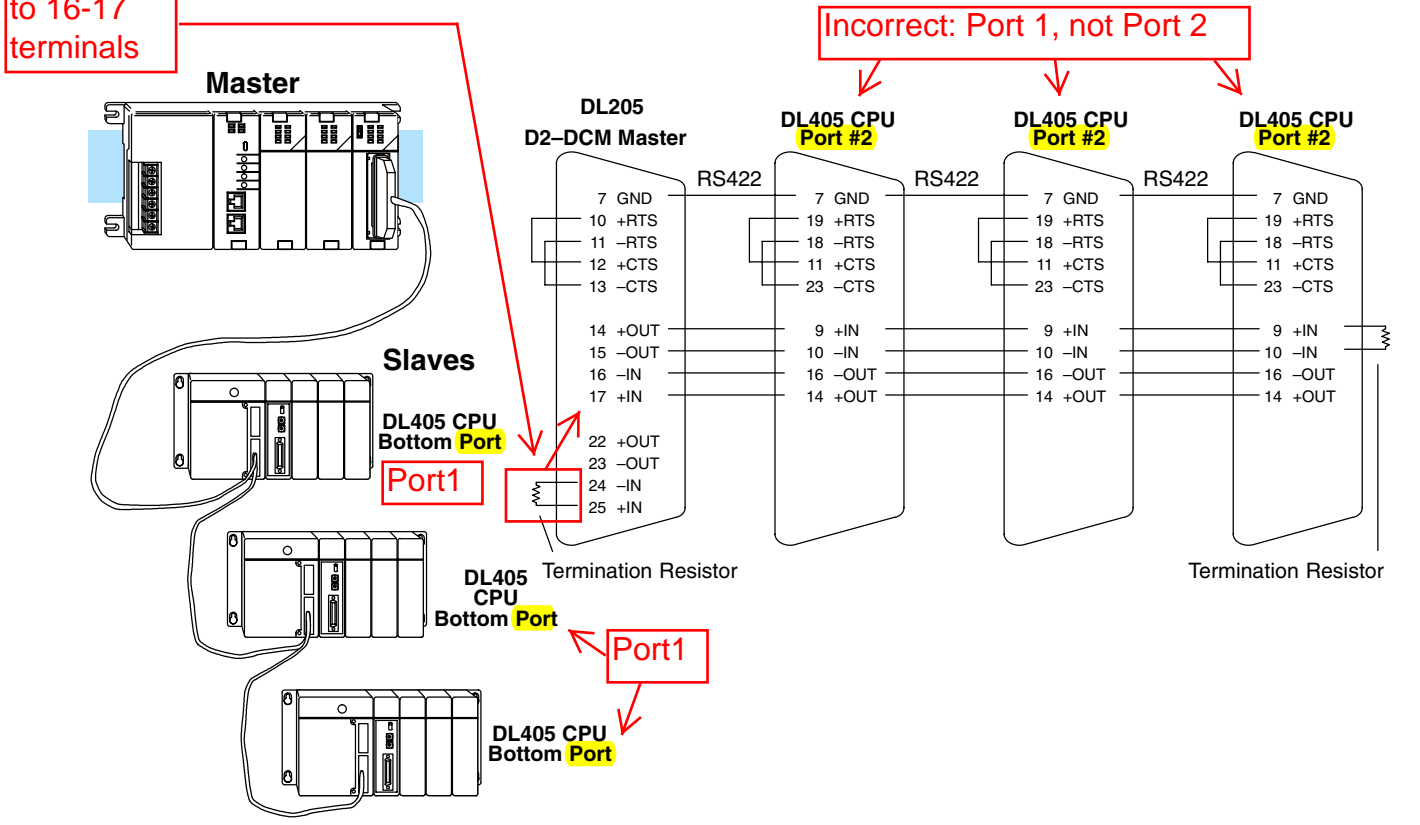
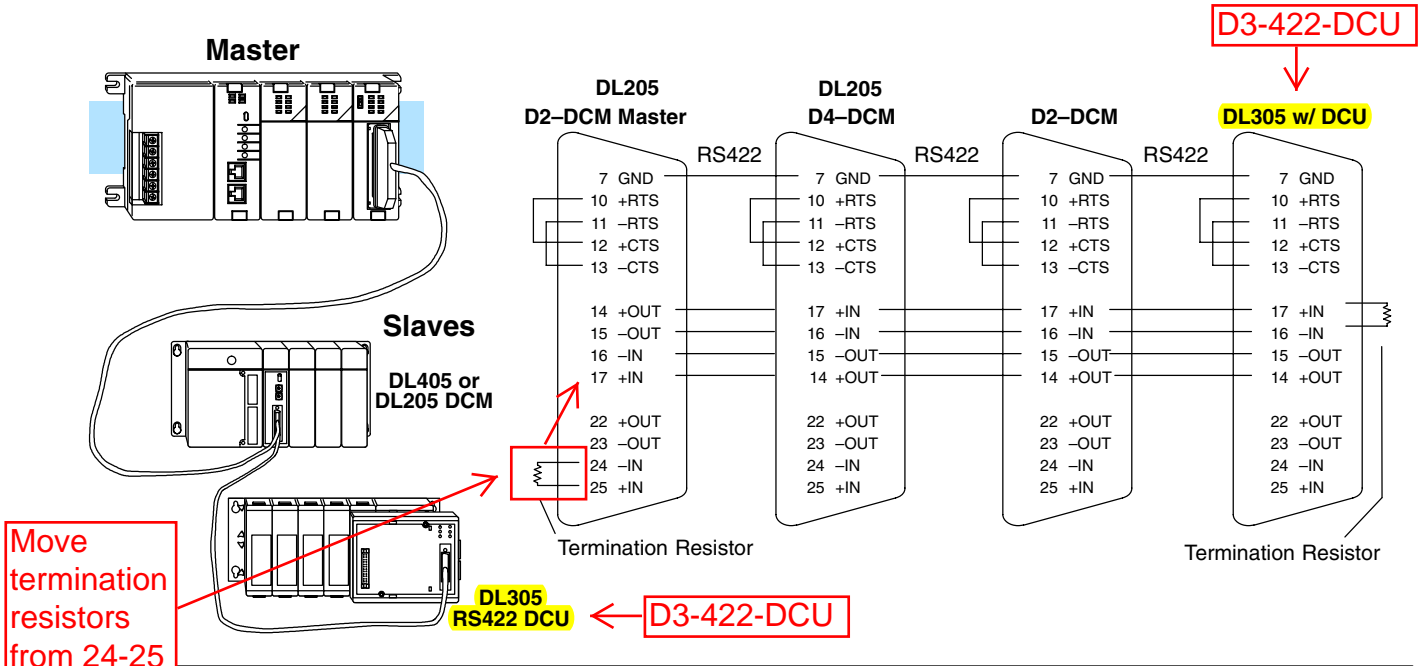

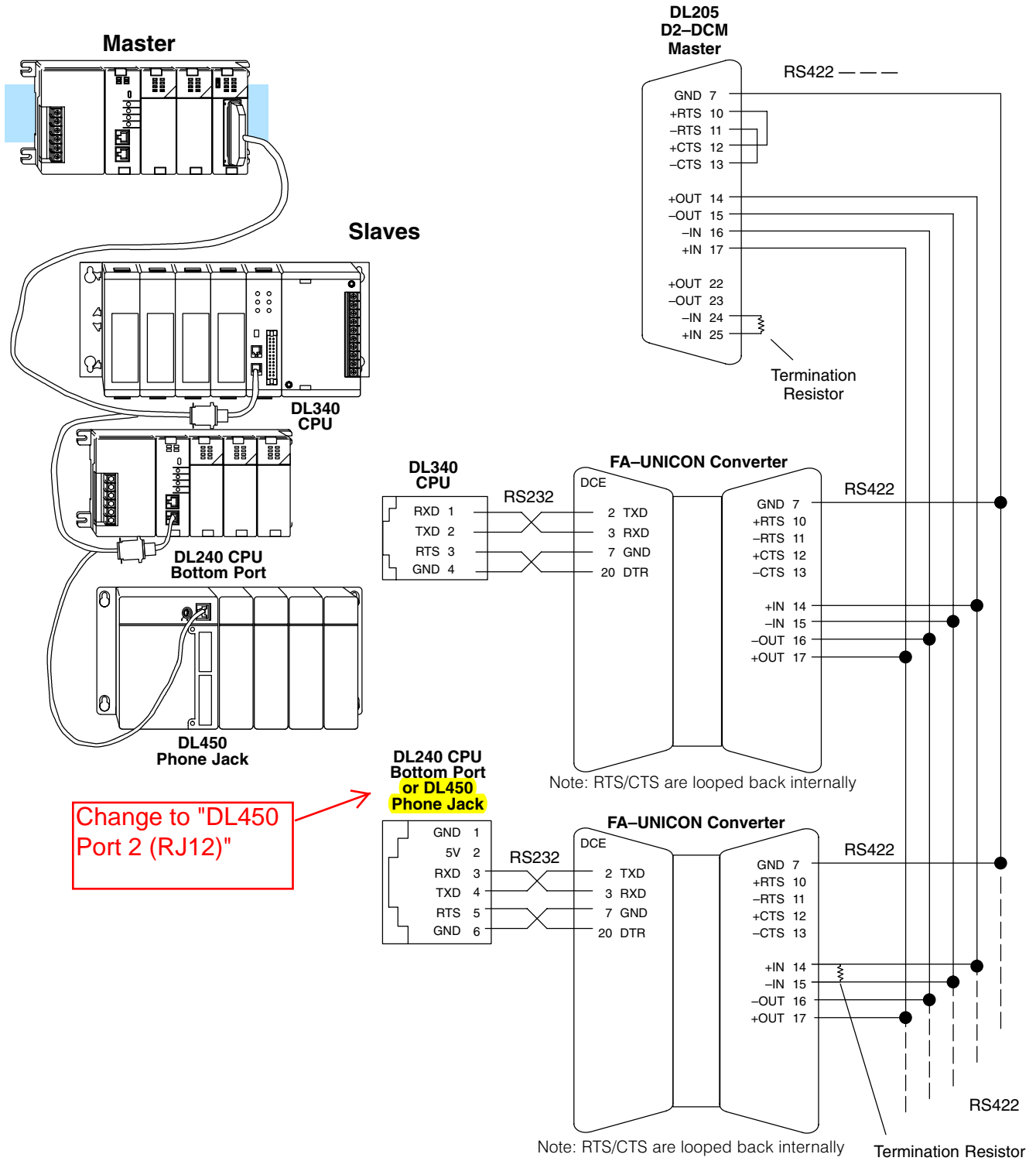

**Multidrop
RS422
PC as Master**

These diagrams show how to connect a network of D2-DCMs to a personal computer.

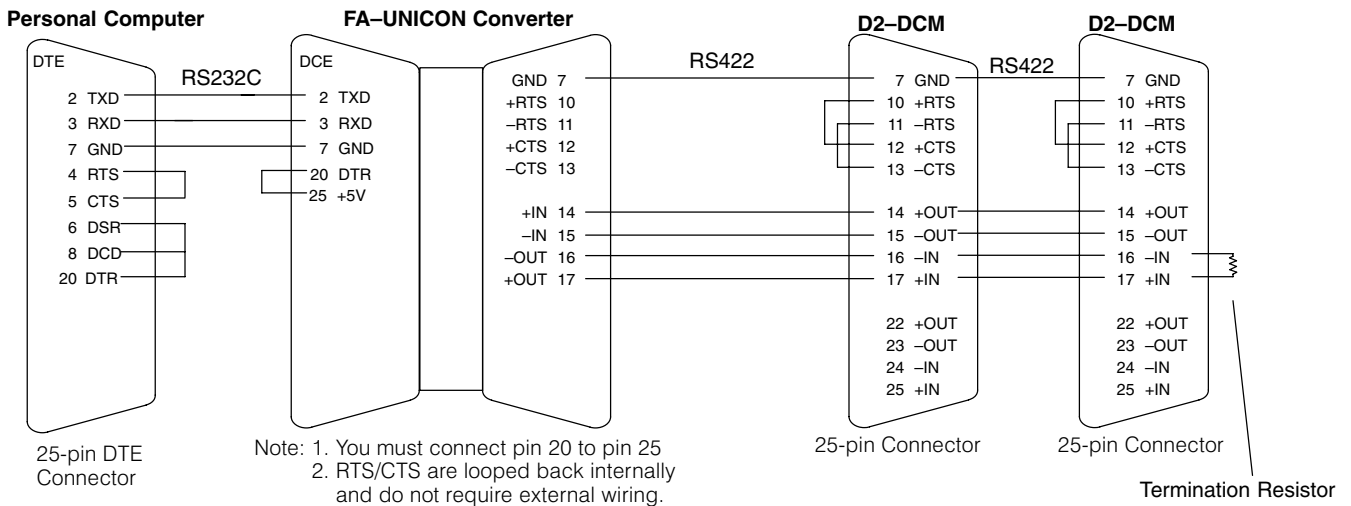
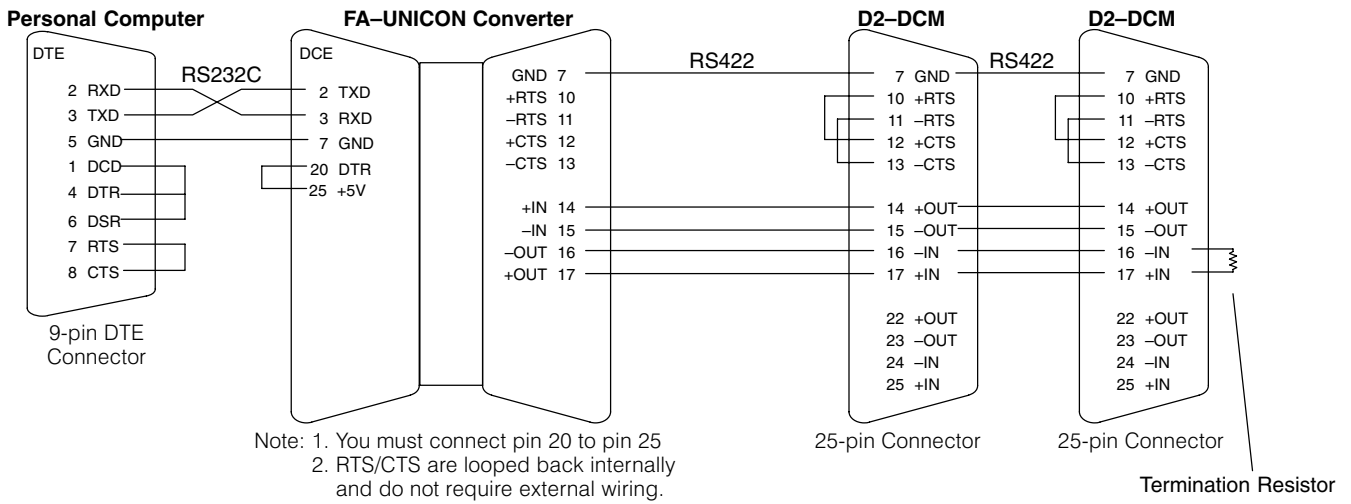
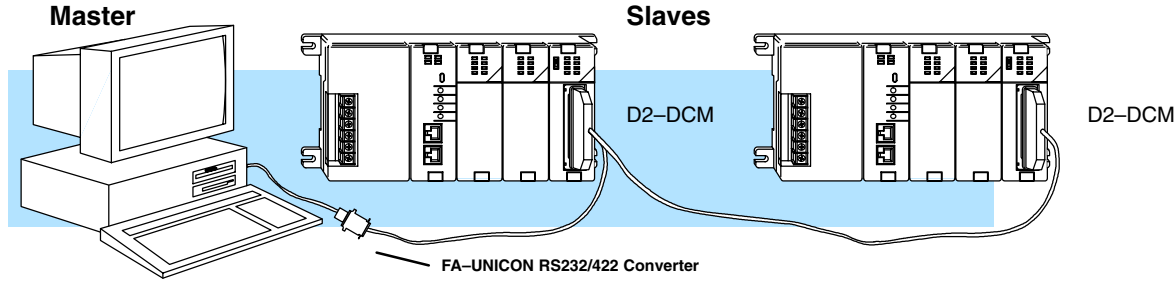

DV-1000 Cable

Use the following cable diagram to connect a DV-1000 to D2-DCM. This is still a simple master/slave connection, but the DV-1000 is the master and initiates the data exchange with the D2-DCM.

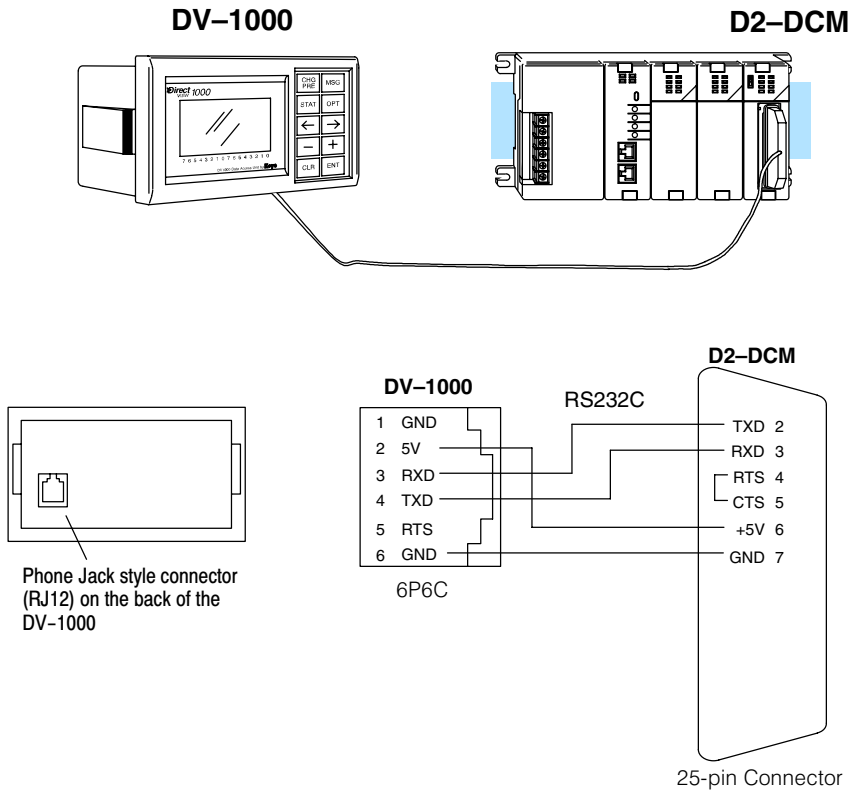

RLL Communications Programs

Why are networking instructions needed in your RLL?

The Master Initiates Requests

Since **DirectNET** is a master/slave network, the master station must initiate requests for network data transfers. If you're using a PLC as the master station, you use simple RLL instructions to initiate the requests.

Why Ladder Logic?

Since the D2-DCM network interface does not contain a program, you have to use the PLC to issue the commands to tell the D2-DCM where to read or write data. The D2-DCM gets information from the PLC and then converts the information into the appropriate **DirectNET** commands. The RLL instructions use or identify the following items.

1. Uses the special relays assigned to the slot to control the communications.
2. Slot location of the D2-DCM master and the slave station address. (LD instruction)
3. Amount of data (in bytes, decimal) you want to transfer. (LD instruction)
4. Area of memory to be used by the master. (LDA instruction, see the DL205 User Manual for a detailed memory map.)
5. Area of memory to be used by the slave, and whether it is a read or write operation. (RX or WX instruction)
6. Interlocks for communication timing and multiple RX and WX routines.

This example reads 3 bytes of data from Slave Address #1, (starting at Y0), into the Master PLC starting at V40600 (Control Relays).

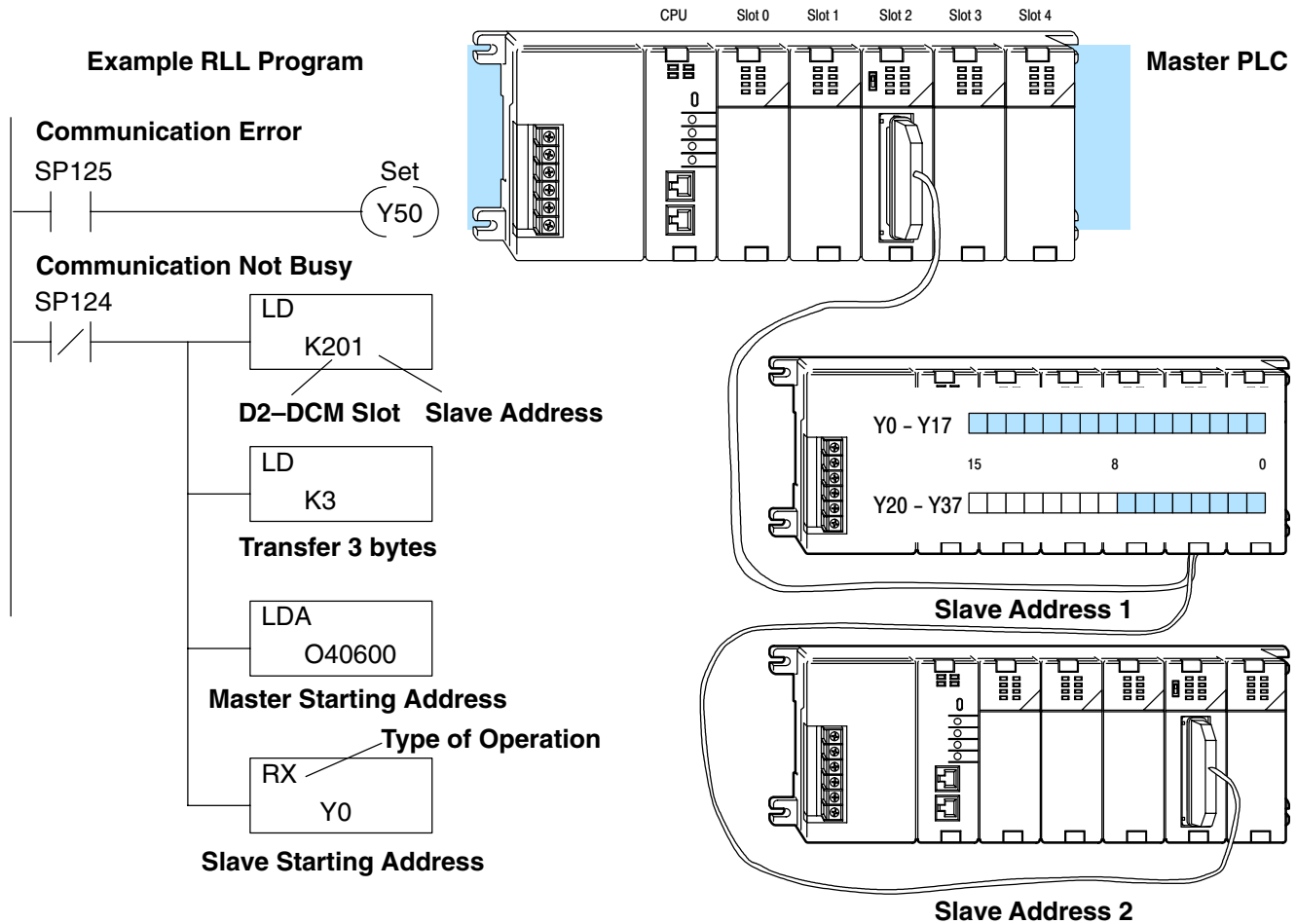

This example writes 3 bytes of data from the Master Station (starting at V40600) to Y0 – Y27 in Slave Station #1.

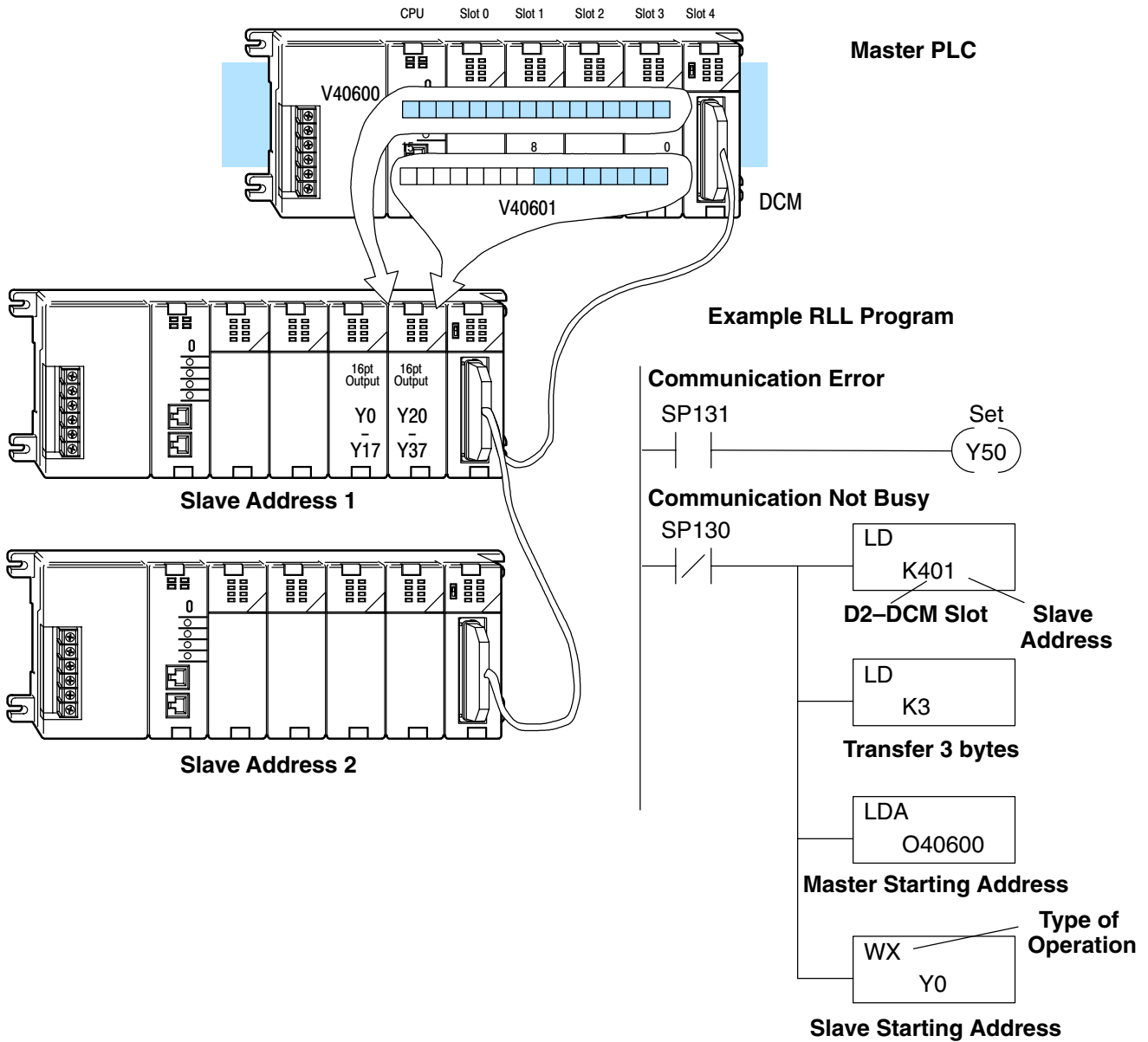

The following paragraphs explain each operation and provide some helpful hints to make your programs simple and easy to follow.

Identifying the master and slave locations & addresses

The first Load (LD) instruction identifies the slot location of the D2-DCM master and the address of the slave station. (Remember, the slot numbers start at 0.)

The constant (K) portion of the instruction actually contains two pieces (bytes) of information. The first two digits specify the D2-DCM master location and the second two digits specify the slave station address.

It is necessary to specify both the master slot location and slave address because you can have more than one D2-DCM master in the base and you can have up to 90 slave stations for each master.

Conversion Hints!

Valid Slot Range: 0-7

Valid Slave Address: 1-90

Example

Master in Slot: 2

Slave Address: 3C HEX (60 decimal)

Convert the HEX address to decimal

0	1	2	3	4	5	6	7	8	9	A	B	C	D	E	F	HEX
0	1	2	3	4	5	6	7	8	9	10	11	12	13	14	15	DEC

HEX 3C

$$3 \times 16 = 48 + C = 12 = 60 \text{ decimal}$$



NOTE: The LD instruction K value is entered in decimal, but the D2-DCM master and slave addresses are in HEX. The HEX addresses must be converted to their decimal equivalent for this instruction. See the conversion hints above.

This example is showing three slaves. In this case the address conversions are simple. Check the Conversion Hints shown above for a more complex example.

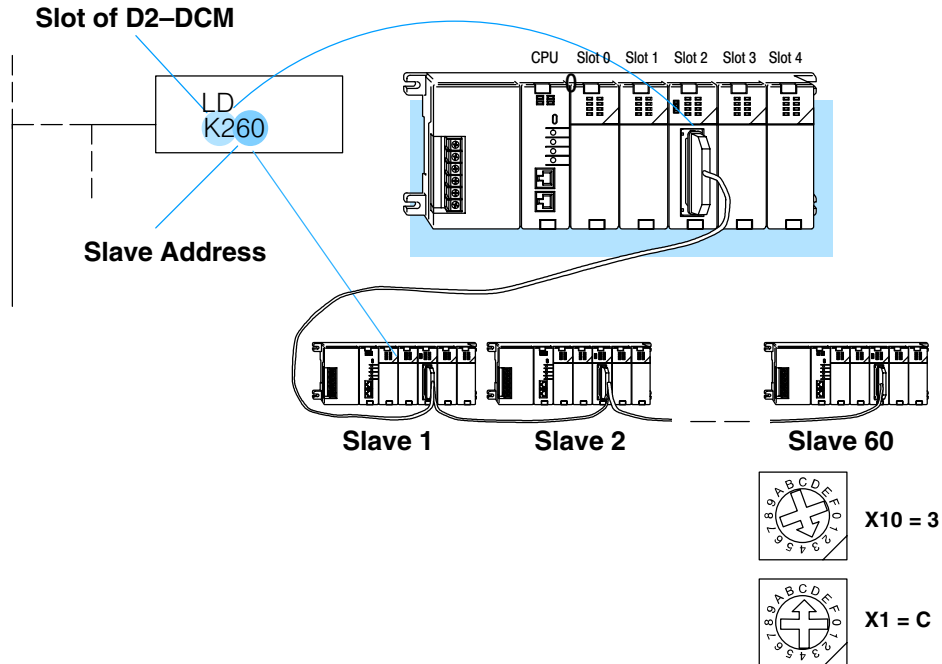

Specifying the amount of data to transfer

The second LD instruction indicates the amount of data that needs to be transferred (in bytes, 128 maximum). You have to specify the amount of data in complete bytes. For example, Y0 – Y27 would be three bytes of data. There are 24 bits for the output range of Y0–Y27 (these I/O addresses are in octal). From the charts below we see that we can obtain 8 bits per byte for this type of memory. Therefore, 24 bits yields 3 bytes, of 8 bits each.

The charts below can be very helpful. Notice that the different PLC families do not always use the same types of memory or the same byte boundaries. For example, the DL305 does not use a separate data type for input and output points.

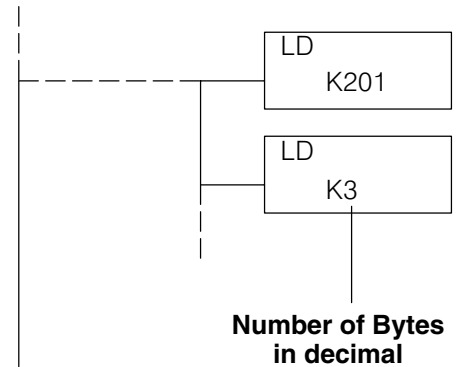

Example:
3 bytes of data to be transferred

The number of bytes specified also depends on the type of data you want to obtain. For example, the DL405 Input points can be accessed by V-memory locations or as X input locations. However, if you only want X0 – X27, you'll have to use the X input data type because the V-memory locations can only be accessed in 2-byte increments. The following table shows the byte ranges for the various types of **DirectLOGIC™** products.

DL 205 / 405 Memory	Bits per unit	Bytes
V memory	16	2
T / C current value	16	2
Inputs (X, GX, SP)	8	1
Outputs (Y, C, Stage, T/C bits)	8	1
Diagnostic Status	8	1

DL305 Memory	Bits per unit	Number of bytes
Data registers	8	1
T / C accumulator	16	2
I/O, internal relays, shift register bits, T/C bits, stage bits	1	1
Diagnostic Status (5 word R/W)	16	10

Designating the master station memory area

The Load Address (LDA) instruction specifies the V memory area of the master that will be used. This is the starting address. Additional sequential locations may be used, depending on the number of bytes that are being transferred. Since all DL405 data is mapped into V memory, you can easily access the data you need.

If you are reading information from the slave station, this is the destination area, or, the area where the master will store the information.

If you are writing information to the slave station, this is the source area, or, the area where the master will obtain the information that will be transferred to the slave.

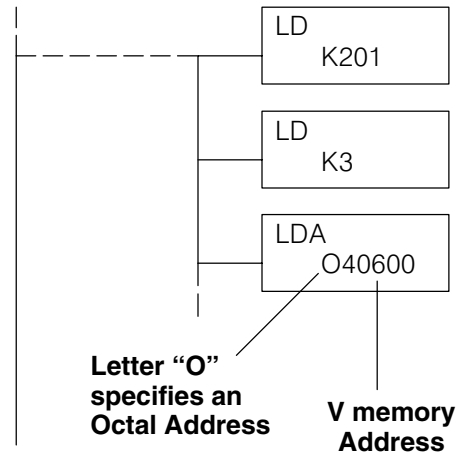

Example:

V memory location 40600 will be the starting point of the data transfer area for the master. The following locations will be used to store the data.

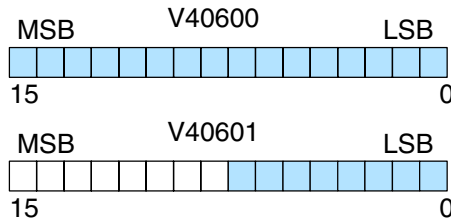

NOTE: Since V memory words are always 16 bits, you may not always use the whole word. For example, if you only specify 3 bytes and you are reading Y outputs from the slave, you will only get 24 bits of data. In this case, only the 8 least significant bits of the last word location will be modified. The remaining 8 bits are not affected.

Identifying the slave station memory area to read or write

The Read Network (RX) or Write Network (WX) is the last instruction in the routine. Use the RX if you want to read data from the slave, or use the WX instruction if you want to write data to the slave.

You have to specify the data type and the starting address for the slave. (Remember, you have to specify a data type that will work correctly with the number of bytes specified.)

If you use the RX instruction, the data will be read from the slave starting at the address specified. If you use the WX instruction, the data will be written to the slave starting at the address specified.

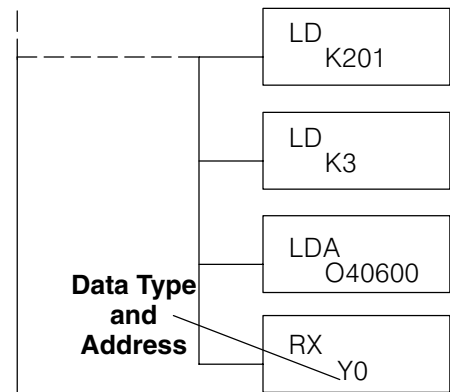

Example:
Read from slave starting at Y0.



NOTE: If you are exchanging data with a DL305 system, it is important to understand how to reference the DL305 memory locations. For example, the DL305 I/O points are accessed with the V data type or the GY data type, even though the DL305 does not actually have those data types present in the CPU. The table on the next page provides a detailed cross reference.

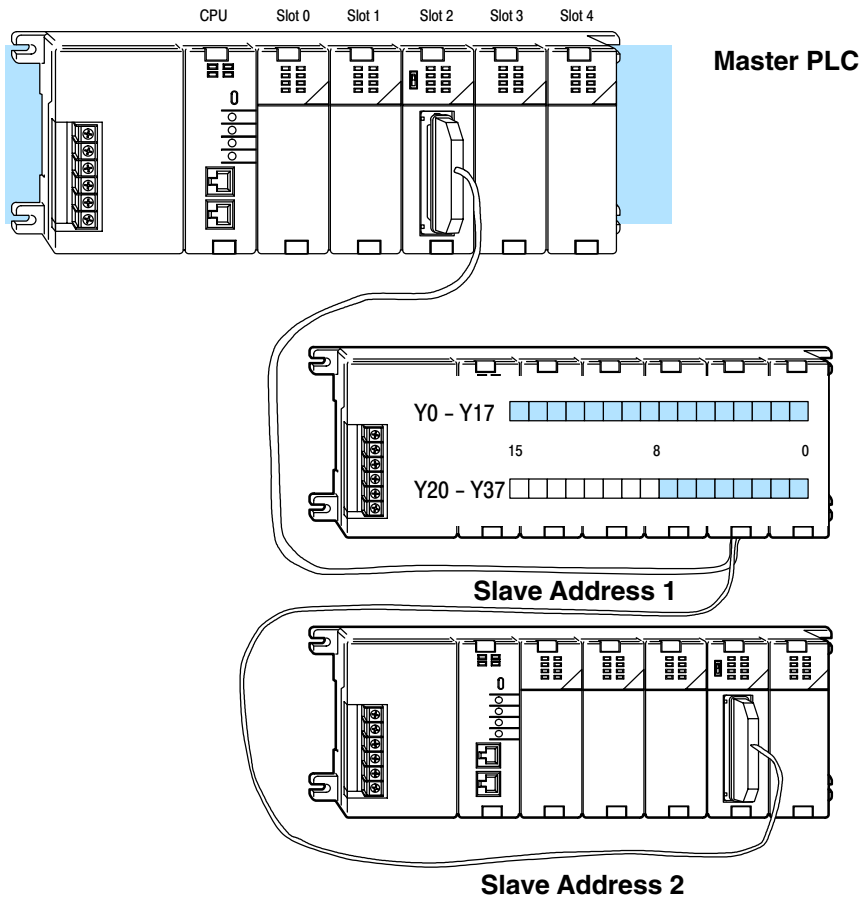

D3-330 / D3-340 CPUs					
To get ...					
TMR/CNT Current Values	use...	TMR / CNT Status Bits	use...	Data Registers	use...
R600	V0	CT600	GY600 ¹	R401, R400 ²	V100
R601	V1	CT601	GY601 ¹	R403, R402 ²	V101
----	----	----	----	----	----
R677	V77	CT677	GY677 ¹	R777, R776 ²	V237
To get ...					
I/O Points	use...	Control Relays	use...	Shift Registers	use...
IO 000	GY0 ¹	CR160	GY160 ¹	SR400	GY400
IO 001	GY1 ¹	CR161	GY161 ¹	SR401	GY401
----	----	----	----	----	----
IO 157	GY157 ¹	CR377	GY377 ¹	SR577	GY577
D3-330P CPUs					
To get ...					
TMR/CNT Current Values	use...	TMR / CNT Status Bits	use...	Data Registers	use...
R600	V0	CT600	GY600 ¹	R401, R400 ²	V100
R601	V1	CT601	GY601 ¹	R403, R402 ²	V101
----	----	----	----	----	----
R677	V77	CT677	GY677 ¹	R777, R776 ²	V237
To get ...					
I/O Points	use...	Control Relays	use...	Shift Registers	use...
IO 000	GY0 ¹	CR160	GY160 ¹	SR200	GY400
IO 001	GY1 ¹	CR161	GY161 ¹	SR201	GY401
----	----	----	----	----	----
IO 157	GY157 ¹	CR277	GY277 ¹	SR277	GY477
To get ...					
Stage Status Bits	use...				
S0	GY200 ¹				
S1	GY201 ¹				
----	----				
S177	GY277 ¹				
<p>1 . You must have CPU firmware V1.9 or greater to use the GY data type in the RX/WX instructions.</p> <p>2 . Two bytes of DL305 register data are returned with one DL205 V memory location.</p>		<p>Example: Read current value from R400 into memory location V2000. If you're just obtaining I/O or Timer/Counter values, the task is fairly simple. But when you work with data registers, it's a bit more involved. Here's why. To get R400, you examine the table and find that you must use reference V0. You will also notice that you always get at least 2 registers! So you get R400 <i>and</i> R401. Since you only want the contents of R400, you have to add some ladder logic to get rid of the data from R401.</p>			

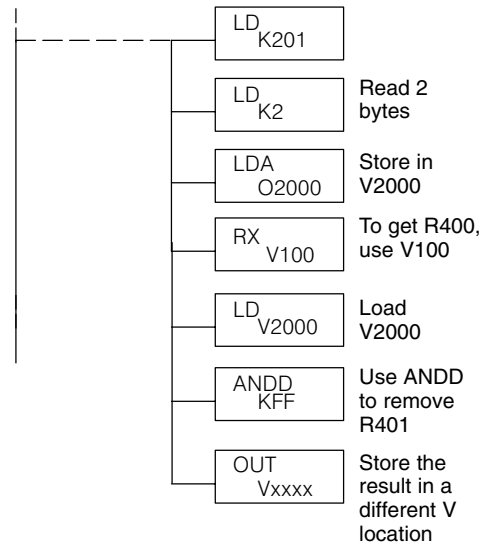

Controlling the communications

Communications Special Relays

Whenever communication is executed with a D2-DCM, chances are the communication will take longer than the actual PLC scan. If the D2-DCM is busy, another request should not be initiated until it is finished. Fortunately, there is an easy solution for this.

There are two SPs for each slot in the CPU base which are used only with the D2-DCM. For example, slot 0 has SP120 and SP121. SP120 is the D2-DCM Busy relay and, when turned on, indicates the D2-DCM is busy. SP121 indicates there is a communication error for slot 0.

You should always use the D2-DCM Busy SP in your RLL programs to ensure the D2-DCM is ready.

The communication error SP is optional, but it is a good way to monitor the communication status in the RLL program. If you use the communication error SP, make sure you place it at the beginning of your communication routines. This is because the communication error relay is always reset (turned off) whenever an RX or WX instruction is executed.

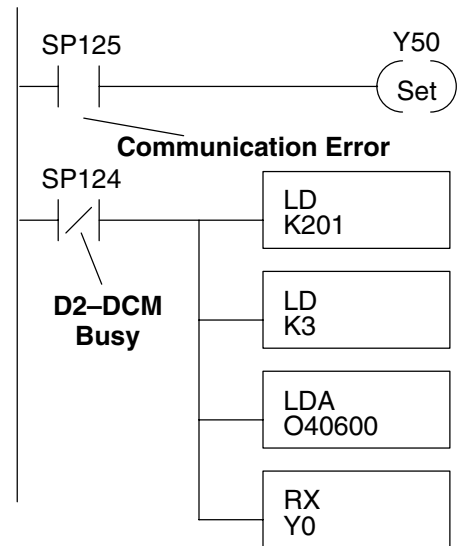

Special Purpose Communication Relays								
I/O Slot Location	0	1	2	3	4	5	6	7
Communication Busy	N/A	SP122	SP124	SP126	SP130	SP132	SP134	SP136
Communication Error	N/A	SP123	SP125	SP127	SP131	SP133	SP135	SP137

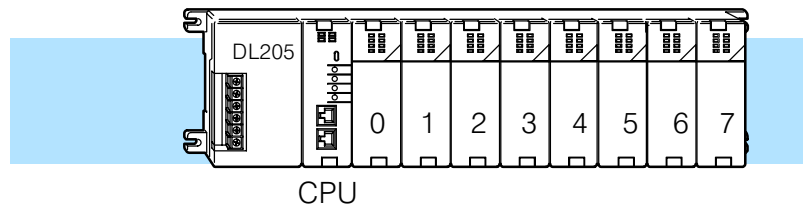

Multiple Read and Write Interlocks

If you're using multiple reads and writes in the RLL program, the routines need to be interlocked to be certain that all the routines are executed. If the interlocks are not used, then the CPU will only execute the first routine. This is because the D2-DCM can only handle one transaction at a time.

In the example, once the RX instruction is executed, C0 is set. When the D2-DCM has finished the communication task, the second routine is executed and C0 is reset.

If you're using RLL^{PLUS}, you can just put each routine in a separate program stage to ensure proper execution. In most all cases, RLL^{PLUS} can be a more efficient way to create an automation program.

The **DirectNET** manual provides a master / slave example with both RLL and RLL^{PLUS} program descriptions.

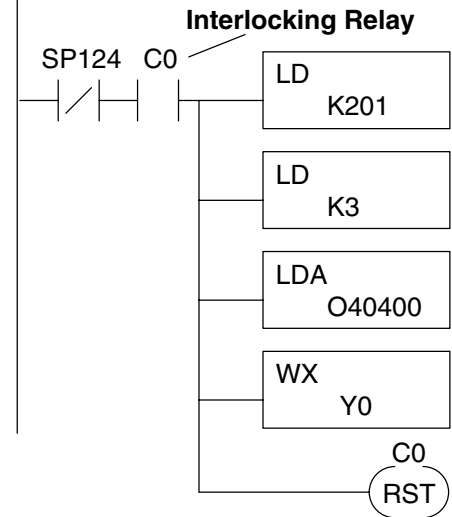
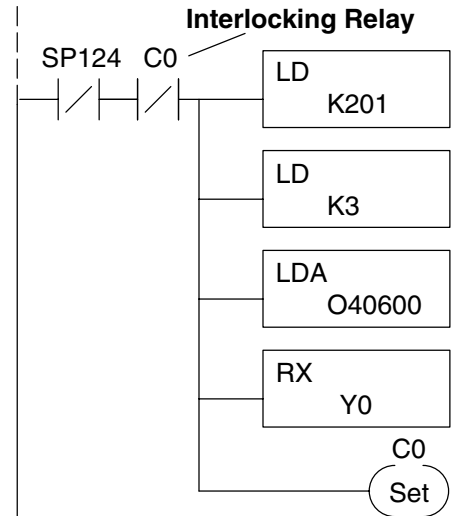

Multiple Read and Write Interlocks

This example is showing three slaves. In this case the address conversions are very simple. Check the Conversion Hints shown above for a more complex example.

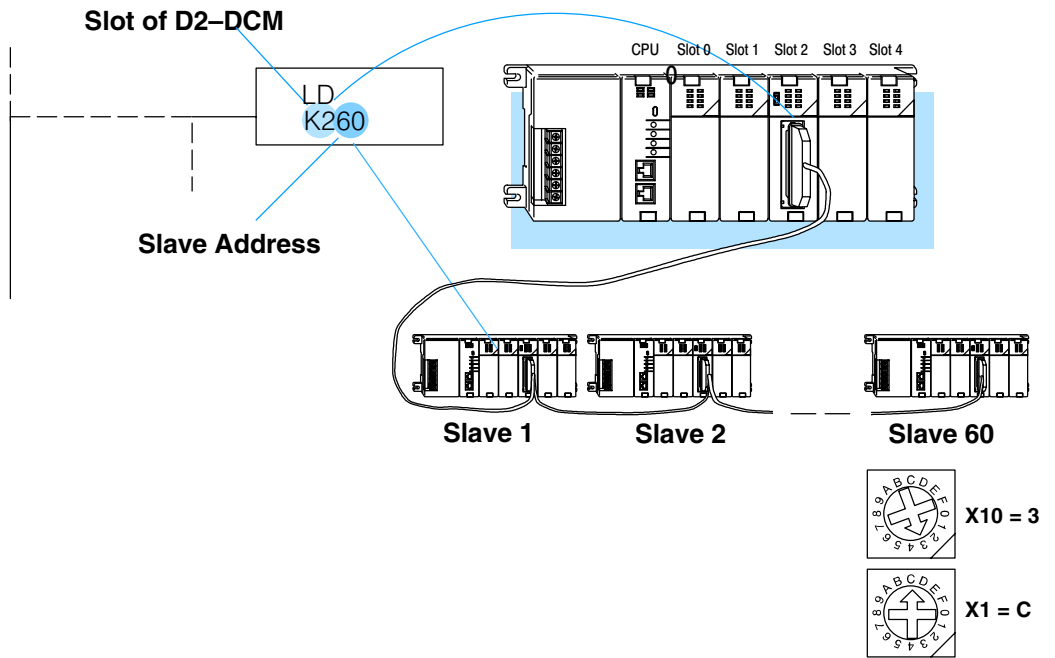

Using the D2–DCM with MODBUS

Introduction

How Does the D2-DCM work with MODBUS?

The D2-DCM can be used as a slave interface to a network using the MODBUS RTU protocol. To use the D2-DCM with MODBUS, your host software must send a MODBUS function code and a MODBUS address to specify a PLC memory location that is understood by the D2-DCM.

Host sends a MODBUS request...

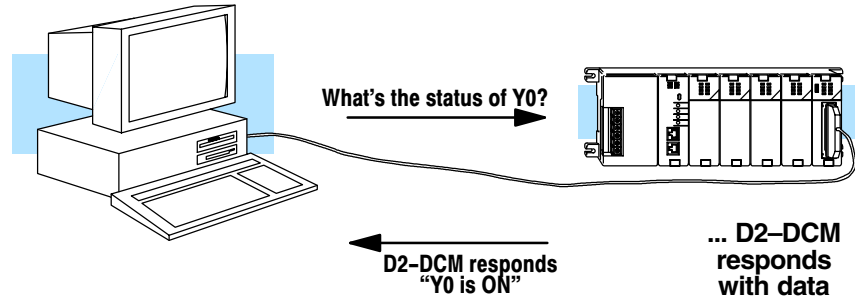

It would be quite difficult to discuss all of the ins and outs of MODBUS in this document. Instead, the purpose of this Appendix is to:

- provide a quick overview of MODBUS Data Types and Function Codes.
- how to determine the proper MODBUS address necessary to allow the host software to access various memory locations in the DL205 system.

One key point to remember is that not all host software packages using MODBUS drivers operate exactly the same way. That is, there are a couple of different ways to achieve the same result, especially when it comes to specifying the needed address for the PLC memory location. *Therefore, it is important that you follow the instructions for your particular software package or network master.*

MODBUS Function Codes Supported

The host software package reads or writes information by sending a MODBUS function code to the D2-DCM. The following table provides a description of the MODBUS function codes supported by the D2-DCM.

MODBUS Code	Function	DL205 Data Types Available
01	Read a group of coils	Y, CR, T, CT
02	Read a group of inputs	X, SP
05	Set / Reset a single coil	Y, CR, T, CT
15	Set / Reset a group of coils	Y, CR, T, CT
03, 04	Read a value from one or more registers	V
06	Write a value into a single register	V
16	Write a value into a group of registers	V



NOTE: The maximum MODBUS secondary address supported by the D2-DCM is 60 (5A hex).

MODBUS Data Types Supported

You are probably accustomed to seeing data types like X input, Y output, C control relay, V memory data registers, etc. for the various types of memory in a DL205 system. For example, if you need to know the status of Y12, then you ask for Y12. MODBUS does not use these same data types, so you have to determine which MODBUS data type corresponds to the PLC memory location that you need. The following table will help.

DL205 Memory Type	Quantity ¹ (Decimal)	PLC Range (Octal)	Corresponding MODBUS Data Type
Inputs (X)	320	X0 – X477	Input
Special Relays (SP)	144	SP0 – SP137 SP540 – SP617	Input
Outputs (Y)	320	Y0 – Y477	Coil
Control Relays (CR)	256	C0 – C377	Coil
Timer Contacts (T)	128	T0 – T177	Coil
Counter Contacts (CT)	128	CT0 – CT177	Coil
Stage Status Bits (S)	512	S0 – S777	Coil
Timer Current Values (V)	128	V0 – V177	Input Register
Counter Current Value (V)	128	V1000 – V1177	Input Register
V Memory, user data (V)	1024	V2000 – V3777	Holding Register
V Memory, user data (V) Non-volatile	256	V4000 – V4377	Holding Register
V Memory, system (V)	106	V7620 – V7737 V7746 – V7777	Holding Register

Determining the MODBUS Address

There are typically two ways that most host software packages allow you to specify a PLC memory location. These are:

- By specifying the MODBUS data type and address.
- By specifying a MODBUS address only.

If the Host Software Requires the Data Type and Address...

Many host software packages allow you to specify the MODBUS data type and the MODBUS address that corresponds to the PLC memory location. This is the easiest method, but not all packages allow you to do it this way. The various MODBUS data types were presented earlier, but they have been included again in the following table.

The actual equation used to calculate the address depends on the type of PLC data you are using. The PLC memory types are split into two categories for this purpose.

- Discrete – X, SP, Y, CR, S, T (contacts), C (contacts)
- Word – V, Timer current value, Counter current value

In either case, you basically convert the PLC octal address to decimal and add the appropriate MODBUS address (if required). The following tables show the exact equation used for each group of data.

DL205 Memory Type	QTY ¹ (Dec.)	PLC Range (Octal)	MODBUS Address Range	MODBUS Data Type
For Discrete Data Types Convert PLC Addr. to Dec. + Start of Range + Data Type				
Inputs (X)	320	X0 – X477	2048 – 2367	Input
Special Relays (SP)	144	SP0 – SP137 SP540 – SP617	3072 – 3167 3280 – 3471	Input
Outputs (Y)	320	Y0 – Y477	2048 – 2367	Coil
Control Relays (CR)	256	C0 – C377	3072 – 3551	Coil
Timer Contacts (T)	128	T0 – T177	6144 – 6271	Coil
Counter Contacts (CT)	128	CT0 – CT177	6400 – 6527	Coil
Stage Status Bits (S)	512	S0 – S777	5120 – 5631	Coil
For Word Data Types Convert PLC Addr. to Dec. + Data Type				
Timer Current Values (V)	128	V0 – V177	0 – 127	Input Register
Counter Current Values (V)	128	V1000 – V1177	512 – 639	Input Register
V Memory, user data (V)	1024	V2000 – V3777	1024 – 2047	Holding Register
V Memory, user data (V) non-volatile	256	V4000 – V4377	2048 – 2303	Holding Register
V Memory, system (V)	106	V7620 – V7737 V7746 – V7777	3984 – 4063 4070 – 4095	Holding Register

DL250-1 Memory Type	QTY ¹ (Dec.)	PLC Range (Octal)	MODBUS Address Range	MODBUS Data Type
For Discrete Data Types Convert PLC Addr. to Dec. + Start of Range + Data Type				
Inputs (X)	512	X0 – X777	2048 – 2560	Input
Special Relays (SP)	512	SP0 – SP137 SP320 – SP717	3072 – 3167 3280 – 3535	Input
Outputs (Y)	512	Y0 – Y777	2048 – 2560	Coil
Control Relays (CR)	1024	C0 – C1777	3072 – 4095	Coil
Timer Contacts (T)	256	T0 – T377	6144 – 6399	Coil
Counter Contacts (CT)	128	CT0 – CT177	6400 – 6527	Coil
Stage Status Bits (S)	1024	S0 – S1777	5120 – 6143	Coil
For Word Data Types Convert PLC Addr. to Dec. + Data Type				
Timer Current Values (V)	256	V0 – V377	0 – 255	Input Register
Counter Current Values (V)	128	V1000 – V1177	512 – 639	Input Register
V Memory, user data (V)	3072 4096	V1400 – V7377 V10000 – V17777	768 – 3839 4096 – 8192	Holding Register
V Memory, system (V)	320	V700 – V777 V7400 – V7777	448 – 768 3840 – 3735	Holding Register

Example 1: V2100

Find the MODBUS address for User V location V2100.

1. Find V memory in the table.
2. Convert V2100 into decimal (1089).
3. Use the MODBUS data type from the table.

PLC Address (Dec.) + Data Type

V2100 = 1088 decimal

1088 + Hold. Reg. = **Holding Reg. 1089**

Timer Current Values (V)	128	V0 - V177	0 - 127	Input Register
Counter Current Values (V)	128	V1000 - V1177	512 - 639	Input Register
V Memory, user data (V)	1024	V2000 - V3777	1024 - 2047	Holding Register

Example 2: Y20

Find the MODBUS address for output Y20.

1. Find Y outputs in the table.
2. Convert Y20 into decimal (16).
3. Add the starting address for the range (2049).
4. Use the MODBUS data type from the table.

PLC Addr. (Dec) + Start Addr. + Data Type

Y20 = 16 decimal

16 + 2049 + Coil = **Coil 2065**

Outputs (Y)	320	Y0 - Y477	2049 - 2367	Coil
Control Relays (CR)	256	C0 - C377	3072 - 3551	Coil

Example 3: T10 Current Value

Find the MODBUS address to obtain the current value from Timer T10.

1. Find Timer Current Values in the table.
2. Convert T10 into decimal (8).
3. Use the MODBUS data type from the table.

PLC Address (Dec.) + Data Type

TA10 = 8 decimal

8 + Input Reg. = **Input Reg. 8**

Timer Current Values (V)	128	V0 - V177	0 - 127	Input Register
Counter Current Values (V)	128	V1000 - V1177	512 - 639	Input Register

Example 4: C54

Find the MODBUS address for Control Relay C54.

1. Find Control Relays in the table.
2. Convert C54 into decimal (44).
3. Add the starting address for the range (3072).
4. Use the MODBUS data type from the table.

PLC Addr. (Dec) + Start Addr. + Data Type

C54 = 44 decimal

44 + 3073 + Coil = **Coil 3117**

Outputs (Y)	320	Y0 - Y477	2048 - 2367	Coil
Control Relays (CR)	256	C0 - C377	3073 - 3551	Coil

If the Host Software Requires an Address ONLY

Some host software packages do not allow you to specify the MODBUS data type and address. Instead, you specify an address only. This method requires another step to determine the address, but it is not difficult. Basically, MODBUS also separates the data types by address ranges as well. This means an address alone can actually describe the type of data and location. This is often referred to as “adding the offset”. One important thing to remember here is that two different addressing modes may be available in your host software package. These are:

- 484 Mode
- 584/984 Mode

We recommend that you use the 584/984 addressing mode if the host software allows you to choose. This is because the 584/984 mode allows access to a higher number of memory locations within each data type. If your software only supports 484 mode, then there may be some PLC memory locations that will be unavailable. The actual equation used to calculate the address depends on the type of PLC data you are using. The PLC memory types are split into two categories for this purpose.

- Discrete – X, GX, SP, Y, CR, S, T (contacts), C (contacts)
- Word – V, Timer current value, Counter current value

In either case, you basically convert the PLC octal address to decimal and add the appropriate MODBUS starting address (as required). The following tables show the exact range used for each group of data.

Discrete Data Types				
Memory Type	PLC Range (Octal)	Address (484 Mode)	Address (584/984 Mode)	Data Type
Global Inputs (GX)	GX0–GX1746	1001 – 1999	10001–10999	Input
	GX1747 – GX3777	—	11000–12048	Input
Inputs (X)	X0 – X1777	—	12049 – 13072	Input
Special Relays (SP)	SP0– SP777	—	13073 – 13584	Input
Global Outputs (GY)	GY0– GY3777	1 – 2048	1 – 2048	Output
Outputs (Y)	Y0 – Y1777	2049 – 3072	2049 – 3072	Output
Control Relays (CR)	C0 – C3777	3073 – 5120	3073 – 5120	Output
Timer Contacts (T)	T0 – T377	6145 – 6400	6145 – 6400	Output
Counter Contacts (CT)	CT0 – CT377	6401 – 6656	6401 – 6656	Output
Stage Status Bits (S)	S0 – S1777	5121 – 6144	5121 – 6144	Output

Word Data Types			
Registers	PLC Range (Octal)	Input/Holding (484 Mode)*	Input/Holding (584/984 Mode)*
V Memory (Timers)	V0 – V377	3001/4001	30001/40001
V Memory (Counters)	V1000 – V1177	3513/4513	30513/40513
V Memory (Data Words)	V1200 – V1377	3641/4641	30641/40641
	V1400 – V1746	3769/4769	30769/40769
	V1747 – V1777	—	31000/41000
	V2000 – V7377	—	41025
	V10000 – V17777	—	44097

* MODBUS: Function 04 (New Feature)

The DL-250, DL-350 and DL450 will support **function 04** read input register (**Address 30001**). To use function 04, put the number '4' into the most significant position (4xxx). Four digits must be entered for the instruction to work properly with this mode.

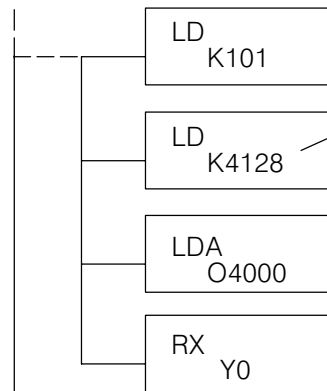

The Maximum constant possible is 4128. This is due to the 128 maximum number of Bytes that the RX/WX instruction can allow. The value of 4 in the most significant position of the word will cause the RX to use function 04 (30001 range).

1. Refer to your PLC user manual for the correct memory mapping size of your PLC. Some of the addresses shown above might not pertain to your particular CPU.
2. For an automated MODBUS/Koyo address conversion utility, download the file **modbus_conversion.xls** from the **www.automationdirect.com** website.

**Example 1: V2100
584/984 Mode**

Find the MODBUS address for User V location V2100.

1. Find V memory in the table.
2. Convert V2100 into decimal (1088).
3. Add the MODBUS starting address for the mode (40001).

PLC Address (Dec.) + Mode Address

$$V2100 = 1088 \text{ decimal}$$

$$1088 + 40001 = \boxed{41089}$$

For Word Data Types		PLC Address (Dec.)	+	Appropriate Mode Address		
Timer Current Values (V)	128	V0 - V177	0 - 127	3001	30001	Input Reg
Counter Current Values (V)	128	V1000 - V1177	512 - 639	3001	30001	Input Reg
V Memory, user data (V)	1024	V2000 - V3777	1024 - 2047	4001	40001	Hold Reg.

**Example 2: Y20
584/984 Mode**

Find the MODBUS address for output Y20.

1. Find Y outputs in the table.
2. Convert Y20 into decimal (16).
3. Add the starting address for the range (2048).
4. Add the MODBUS address for the mode (1).

PLC Addr. (Dec) + Start Address + Mode

$$Y20 = 16 \text{ decimal}$$

$$16 + 2048 + 1 = \boxed{2065}$$

Outputs (Y)	320	Y0 - Y477	2048 - 2367	1	1	Coil
Control Relays (CR)	256	C0 - C377	3072 - 3551	1	1	Coil
Timer Contacts (T)	128	T0 - T177	6144 - 6271	1	1	Coil

**Example 3: T10
Current Value
484 Mode**

Find the MODBUS address to obtain the current value from Timer T10.

1. Find Timer Current Values in the table.
2. Convert T10 into decimal (8).
3. Add the MODBUS starting address for the mode (3001).

PLC Address (Dec.) + Mode Address

$$TA10 = 8 \text{ decimal}$$

$$8 + 3001 = \boxed{3009}$$

For Word Data Types		PLC Address (Dec.)	+	Appropriate Mode Address		
Timer Current Values (V)	128	V0 - V177	0 - 127	3001	30001	Input Reg
Counter Current Values (V)	128	V1000 - V1177	512 - 639	3001	30001	Input Reg
V Memory, user data (V)	1024	V2000 - V3777	1024 - 2047	4001	40001	Hold Reg.

**Example 4: C54
584/984 Mode**

Find the MODBUS address for Control Relay C54.

1. Find Control Relays in the table.
2. Convert C54 into decimal (44).
3. Add the starting address for the range (3072).
4. Add the MODBUS address for the mode (1).

PLC Addr. (Dec) + Start Address + Mode

$$C54 = 44 \text{ decimal}$$

$$44 + 3072 + 1 = \boxed{3117}$$

Outputs (Y)	320	Y0 - Y477	2048 - 2367	1	1	Coil
Control Relays (CR)	256	C0 - C377	3072 - 3551	1	1	Coil
Timer Contacts (T)	128	T0 - T177	6144 - 6271	1	1	Coil

Using the D2–DCM with Modems

Introduction

There are some applications that require a remote connection to the PLC. These remote connections require you to use a modem to communicate between the Personal Computer and the PLC system. Although this manual tends to focus on using the D2-DCM in networking applications, there are a tremendous number of people who simply use the D2-DCM as an extra communications port. The D2-DCM provides additional flexibility in configuration and baud rates compared to the built-in port on the CPU, so it's a logical choice for use with a modem.

It is not hard to establish remote communications with a PLC system via a modem. This appendix provides some guidelines to help you setup the communications link.

System Components There are typically two types of communication paths for modem applications.

- Telephone modems
- Radio modems

Both serve the same basic function, which is to enable data communications over a long distance. However, your choice really depends on your particular application. Radio modems are typically more expensive and can be more difficult to use in some situations. But if you don't have phone lines or dedicated cabling in the area, your choice may be restricted to radio modems anyway.

For the DL205 family of products, any system that is designed to handle modem communications usually contains components from the following list.

- DL240 PLC System with D2-DCM
- PLC System with DL250-1/260 CPU bottom port
- Personal Computer
- 2 modems (one on each end)

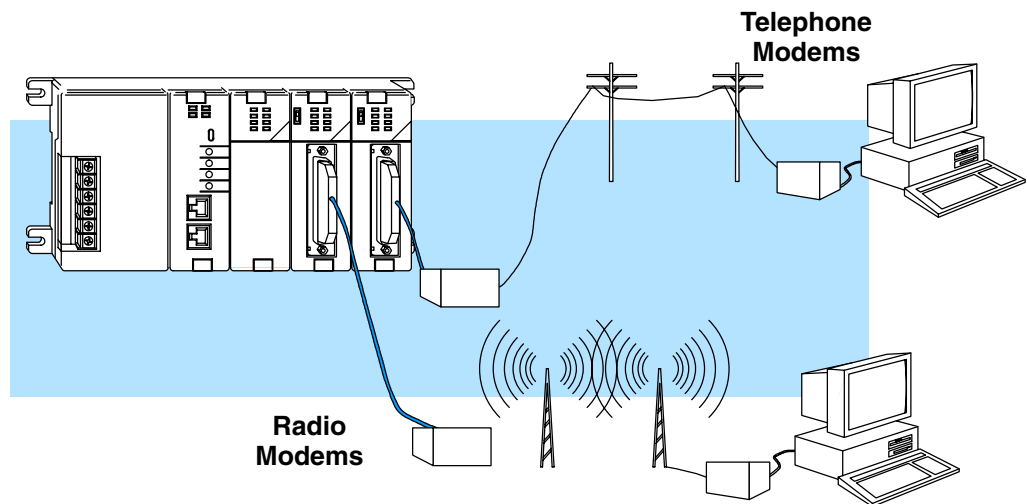

Possible Configurations

Even though most all systems have one or more of the system components, there are a couple of ways that they can be used.

PC Master — Some people need to use modems between a personal computer and the PLC system so that they can perform remote programming and/or data monitoring tasks with PC-based software, such as *DirectSOFT32* or a SCADA system. In this case, the personal computer is the master and the PLC system is the remote slave station.

D2-DCM Master — In other situations, you may be using a D2-DCM as the remote communications master instead of a personal computer. If you are considering this, you **must** have one of the following situations.

- **You have a Leased-line** — You can have a leased (dedicated) phone line if modems are used. A dedicated line is necessary because the D2-DCM cannot issue the dial-up commands, so the carrier must be active at all times.
- **You have a Radio Link** — You also have the option of using radio modems. This is useful when it is not feasible to have hard-wired communications cabling between the remote stations.
- **You have a MDM-TEL** — It has the capability of on contact initiated dialing.

In either case, the cabling and setup requirements share many similarities, which are covered later in this Appendix.

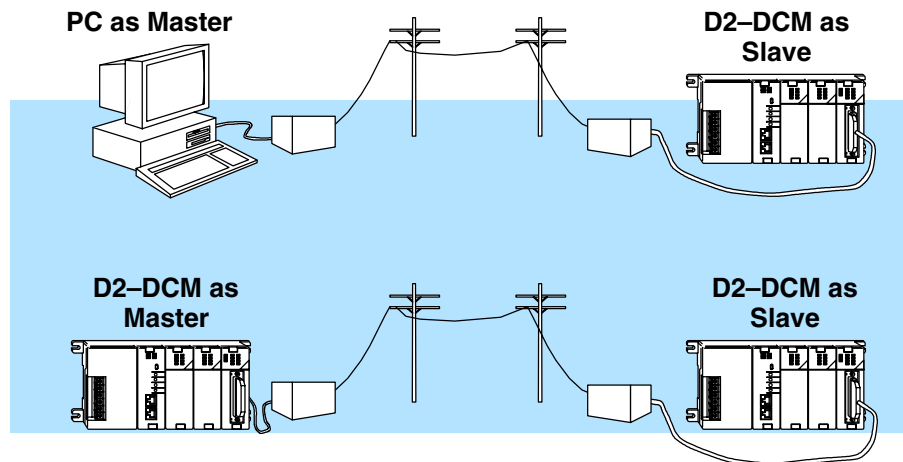

Choosing a Modem

With today's prices, it is possible to buy a high quality modem for a reasonable price. It is recommended that you purchase a modem not because it is inexpensive, but because it has a good reputation. This will save you money (and time) over the long run. It is also suggested that you spend a few extra dollars to get an external modem if possible. The internal versions typically do not have status indicator lights and are much harder to debug during setup, or modem communication failure.

We recommend using **AutomationDirect's MDM-TEL**, Industrial Telephone Modem. It is an external modem which is DIN-rail mounted. This is a rugged industrial telephone modem which has been designed for operation in electrical enclosures which are installed in harsh environments. This MDM-TEL supports all standard Hayes AT commands, Fax Class 1 and Class 2 commands and S-registers, therefore it can be setup as an external modem on any PC. This industrial modem is compatible with any telecommunications or dial-up networking software. The MDM-TEL is also fully supported by **AutomationDirect's** technical support team. More detailed information can be located at www.automationdirect.com.

Set the D2-DCM Switches

For the most part, we suggest that you follow the setup instructions shown earlier in this manual. That is, choose the protocol you're using, set the station address, etc. However, there are a couple of important differences which are discussed here.

Baud Rate & Parity

It is important that you select the following communications parameters when you use the D2-DCM for remote communications.

- 9600 baud
- NO parity

The parity setting is most important. Most popular modems cannot transmit an odd number of bits per character. If parity is enabled, each character would consist of 1 start bit, 8 data bits, 1 parity bit and 1 stop bit, making a total of 11 bits per character. Since this is an odd number, the modem would not work properly. You can experiment with the baud rate settings, but make sure all components are set to the same baud rate.

Delay Time

If you're using a radio modem, you may have to set a delay time for the communications. This time is necessary to allow time for the radio to "key-up" before the data is transmitted. You must match the settings required by your modem.

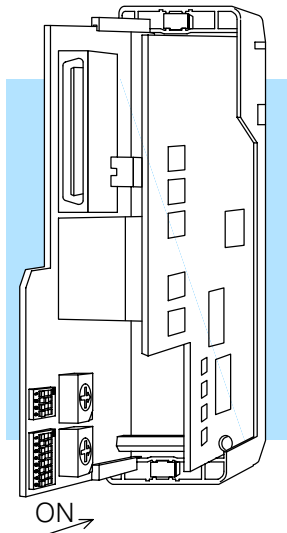

Switch Positions	6	7	8
0	OFF	OFF	OFF
2	ON	OFF	OFF
5	OFF	ON	OFF
10	ON	ON	OFF
20	OFF	OFF	ON
50	ON	OFF	ON
100	OFF	ON	ON
500	ON	ON	ON

*Delay time in milliseconds

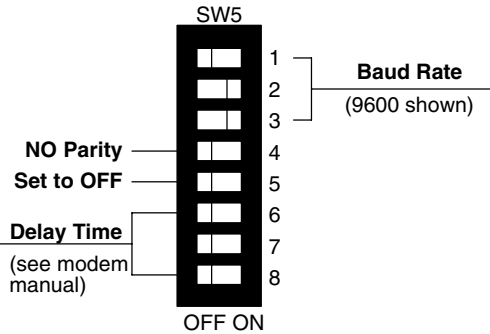

Baud	Switch Positions		
	1	2	3
300	ON	OFF	OFF
600	OFF	ON	OFF
1200	ON	ON	OFF
2400	OFF	OFF	ON
4800	ON	OFF	ON
9600	OFF	ON	ON
19200	ON	ON	ON
38400	OFF	OFF	OFF

Delay Time Considerations for Networks with DL240 Slaves

A couple of scenarios have been mentioned where you may be using a D2-DCM connected to a modem as the master station and a DL240 CPU connected to a modem as the slave station. If you have such a situation, there are a couple of things that you may have to take into consideration.

If you are using a radio modem connected to the bottom port of a DL240, you will probably have to set a delay time for the CPU port. You can do this by loading a BCD value into V7632. This is a special V-memory location which defines the baud rate and/or time delay for the bottom port. It is recommended that you do this on the first scan within your ladder program. The following diagram provides a table of the settings and an example of some simple setup logic that could be included in your RLL program.

V7632	
MSB	LSB
X	X
<u>Delay Codes</u>	
00	No delay
01	2ms delay
02	5ms delay
03	10ms delay
04	20ms delay
05	50ms delay
06	100ms delay
07	500ms delay
<u>Baud Rate Codes</u>	
00:	300 baud
01:	1200 baud
02:	9600 baud
03:	19200 baud

Example:
First Scan Only, Load Delay Time of 5ms & Baud Rate of 19200 for Bottom Port

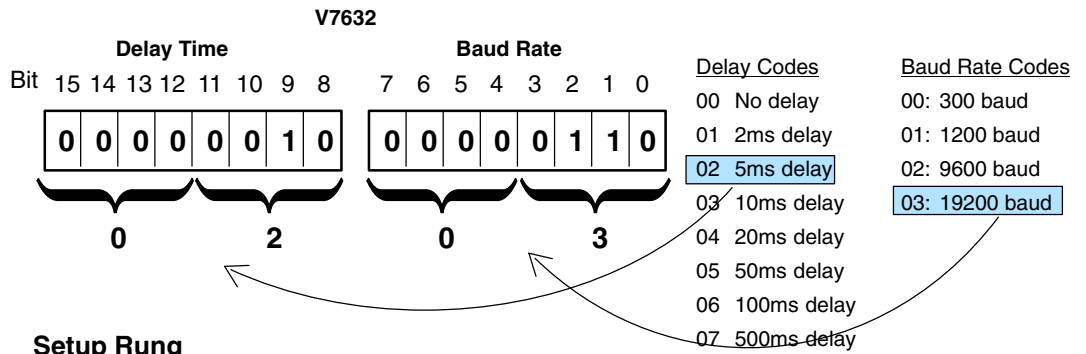

Setup Rung

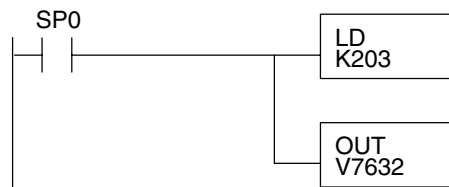

Use the LD (Load) instruction to load the BCD codes for each parameter into the accumulator. The number 0203 is just the code used for our particular example, which is a 5ms delay, 19.2K baud.

Place the value in memory location V7632

Main Ladder Program Begins

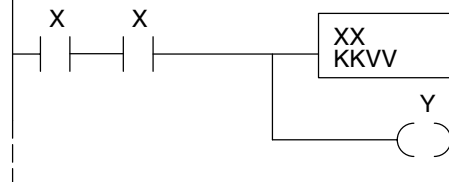

After the parameter setup rung(s) above, we begin the normal ladder program. Use your actual program for this and the following rungs.

Choose the Proper Cables

The exact cables needed really depend on your particular application. In any case, you will probably use one or more of the following connections.

- Personal Computer to modem connection
- Modem to D2-DCM connection
- Modem to DL240 connection

Connecting a Modem to your Personal Computer

Your choice of cable for connecting the modem to your personal computer depends on whether you have a 9-pin port or a 25-pin port on your COM card. In either case, it's usually easier to buy a cable rather than make one. It is suggested that you check your modem documentation to see what the manufacturer recommends. If your documentation does not recommend a cable, you could try the following sources.

- Radio Shack
- Black Box Catalog

Some users prefer to build their own cable. Here are the pinouts that are usually required. Again, check your modem documentation for the exact requirements.



NOTE: The 9-pin diagram can be confusing because it shows TXD – TXD and RXD – RXD connections. This is actually correct because the 9-pin connector conforms to the IBM standard for DTE and the 25-pin side conforms to the standard for DCE. This results in the slight confusion over the terminology used to label the TXD and RXD pins.

9 to 25 Pin Cable

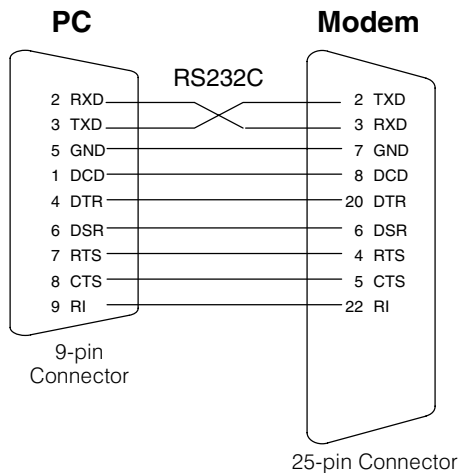

25 to 25 Pin Cable

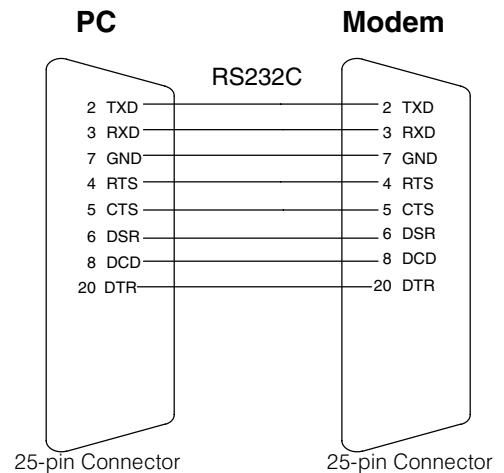

Connecting a Modem to the D2-DCM

The PLC is on the other end of the remote communication link and will typically have a D2-DCM as the communications interface. Just as you needed a cable to connect your personal computer to the modem, you'll also need a cable between the PLC system (D2-DCM) and the receiving modem. Since the D2-DCM and the modem have 25-pin connectors, use the straight-through 25-pin to 25-pin cable diagram shown here.

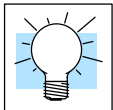
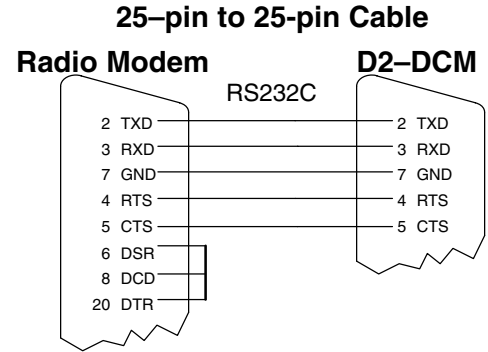
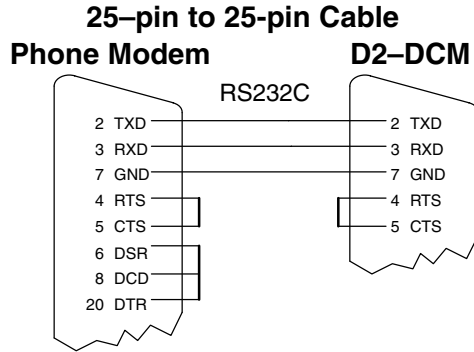

Tip: You can use our D3-DSCBL-2 with a null modem adapter to quickly build a cable which can connect the modem to the D2-DCM (also used with the MDM-TEL modem). You'll need the following parts, which can be obtained at most any electronics store. Since there seems to be a Radio Shack on every corner, we've included their part numbers.

- **D3-DSCBL-2** — Automationdirect DL305 Programming Cable
- **26-1496** — Radio Shack DB25 Null Modem Adapter
- **26-1388** — Radio Shack DB25 Male to DB9 Male Adapter

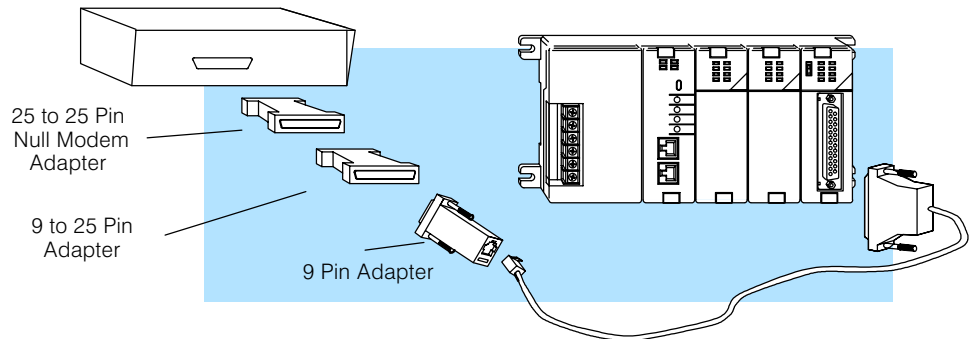

Connecting a Modem to the DL240

Use the cable diagram shown here to connect a modem to the bottom port of a DL240 CPU.

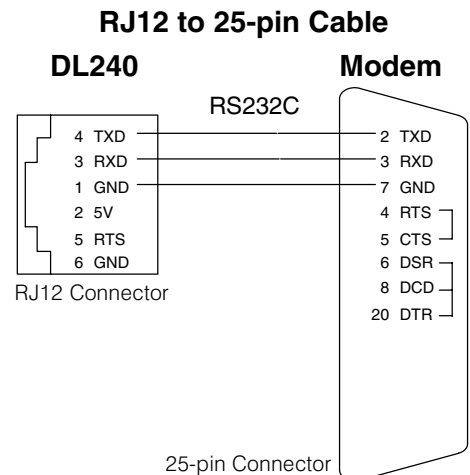

Using the MDM-TEL

The MDM-TEL industrial modem, which is fully supported by **AutomationDirect**, is a sensible choice for your application. The MDM-TEL User Manual, which can be downloaded from the **AutomationDirect** website, will provide more detailed information.

RS232 Connections

Use a straight-through or equivalent serial cable to connect the modem's RS232 female port (DB9 cable male end) to the RS232 male port on a PC or other "Data Terminal Equipment" (DTE) device (DB9 cable female end). The diagram below details the pin-out of a straight-through serial communications cable suitable for connecting a DCE device (MDM-TEL) to a DTE device (PC, PLC or other device). A suitable DB9 RS-232 cable is provided with the MDM-TEL.

MODEM RS232 Connections

Cable for MODEM to IBM COM Port

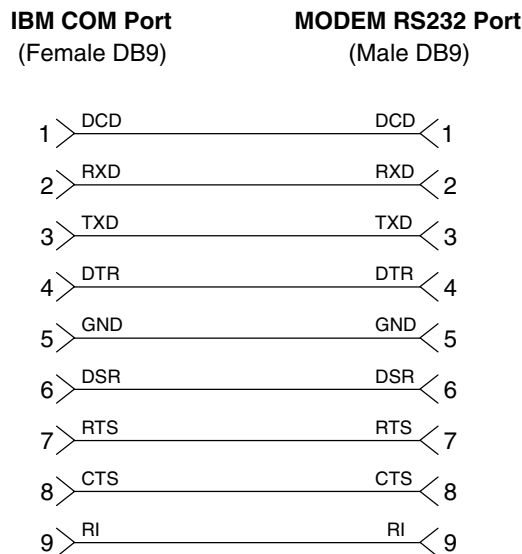

MODEM CABLE WIRING

(Standard DB9 Cable)

To simplify the connection between the D2-DCM and the MDM-TEL modem purchase a D3-DSCBL-2 cable available from **AutomationDirect**. The null modem adapter supplied with the modem is required when using this cable.



The MDM-TEL Setup Wizard

A modem setup utility is provided on the MDM-TEL CD to help you quickly configure the modem. In most applications, no knowledge of modem AT commands or S register contents is necessary. Pre-configured profiles, for common situations, are provided for convenience.

D2-DCM as Master

If You are Using a D2-DCM as Master

If you are using the D2-DCM as a master connected directly to a modem, then you must be using one of two types of modems. In either case, there are no special procedures that are required.

- **Leased-line Modem** — If you have a leased line modem, it tries to establish communications with the remote modem as soon as the power is turned on. The carrier stays active as long as the power is on. (That's why they call them "dedicated" lines.) After they are connected, the RX or WX instruction in the RLL program controls the data transmission between the stations. That is, when the RX or WX is executed, it automatically causes the D2-DCM's Request to Send line to go high. The modem responds with a Clear to Send and the communications begins.
- **Radio Modems** — If you have a radio modem, the RX or WX instruction in the RLL program controls the data transmission between the stations. That is, when the RX or WX is executed, it automatically causes the D2-DCM's Request to Send line to go high. The modem responds with a Clear to Send and the communications begins. The radio modem broadcasts the request and (hopefully) the remote station will receive it and respond accordingly.
- **MDM-TEL** — If you have a MDM-TEL modem, you can have the modem dial a preconfigured phone number by applying +24VDC to the "From PLC" terminal on the modem. When the modem connects to another modem and establishes communications, the modem will then apply +24VDC to the "to PLC" terminal. This input to the PLC is used to initiate RX or WX commands from the RLL program. If you do not have either a sourcing DC output or a sinking DC input, you will need to add a D2-08CDR module to your system in order to control the signals to/from the modem.

Using *DirectSOFT32*

Creating a Modem Link

DirectSOFT32 uses Telephony Application Programming Interface (TAPI) for modem configurations. The TAPI protocol allows applications to control modems or other telephony devices for operations such as dialing, answering, or disconnecting a connection. With the TAPI protocol, all of the modem support is centralized by the Windows operating system.

By using the TAPI interface, you will use the Windows modem setup utilities to configure the modem. Configuring the modem in this manner should simplify the setup process and allow you to select the most recent drivers for your modem.

If there is an existing modem connected to your PC for Internet or fax use, the modem setup will have to be changed. Some of the features will have to be disabled in order to communicate to the PLCs. To avoid making any changes to the existing modem configuration, you will need to install the same modem a second time. Windows will change the name by adding a number to the end i.e., “*modemname#2*” each time you add the same modem to your PC. Refer to your PC and/or modems installation manual for additional information on setting up your modem.

Modem Setup

The first series of examples were performed in Windows 2000 and will illustrate how to configure the modem connected to your PC. The examples may differ depending on your Windows operating system.

1. Install the modem if not already installed. Refer to the modem’s documentation for installation information. If the modem is to be used for other devices you will need to install it a second time.
2. Once you have successfully installed the modem, you will need to edit its properties. In the Windows **Start** field, select **Settings > Control Panel**.

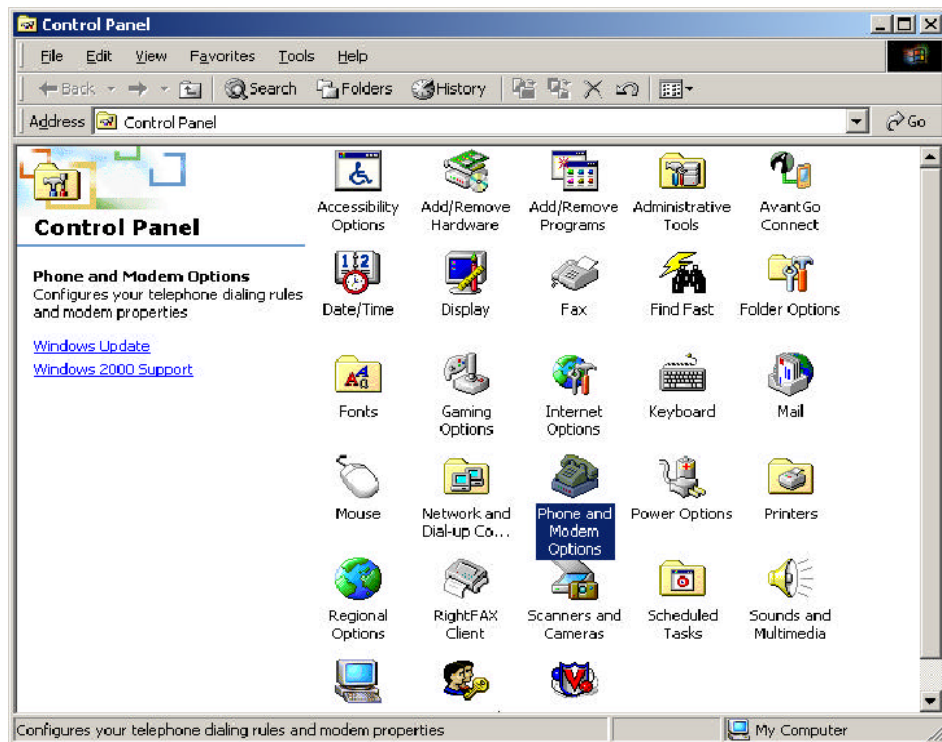

3. Select the **Phone and Modem Options** icon. A dialog box with all available modems installed will appear.
4. Choose the **Modems** tab, then click on **Properties** at the bottom.

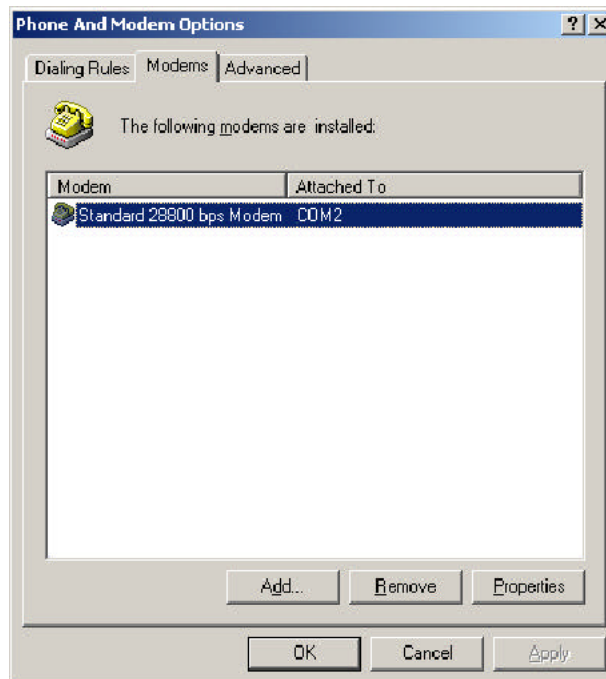

5. Choose 9600 as the **Maximum Port Speed**.

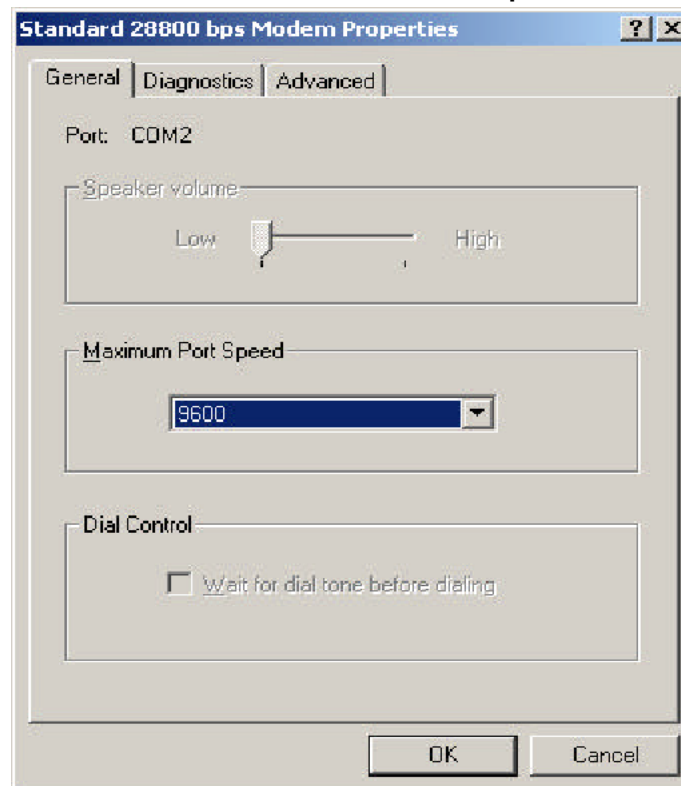

6. Select the **Advanced** tab and click on **Change Default Preferences**.

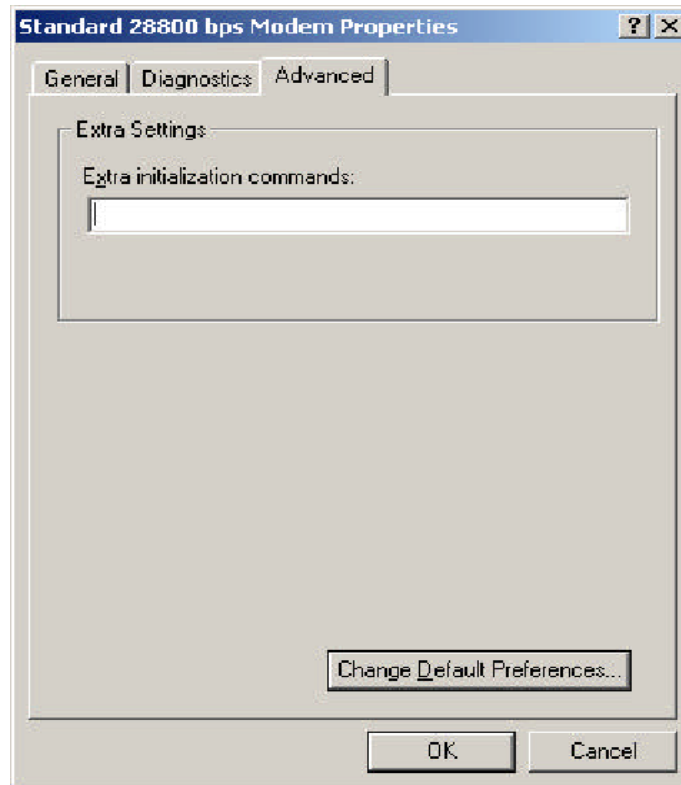

7. Make **Port speed** 9600, and choose None for **Flow control**.

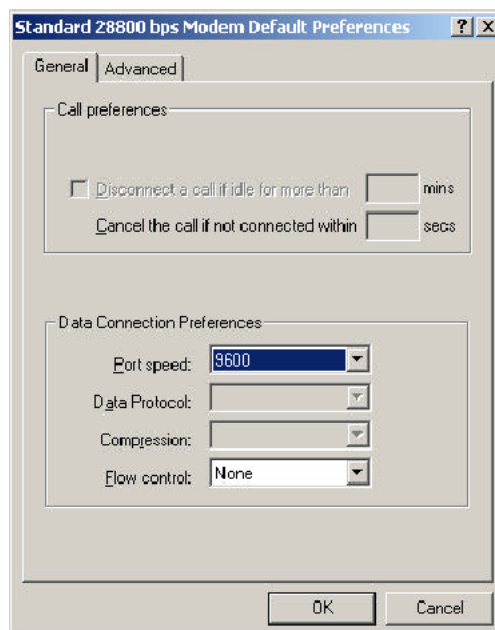

- Click on the **Advanced** tab and choose 8 **Data bits**, None **Parity** and 1 **Stop bits**.

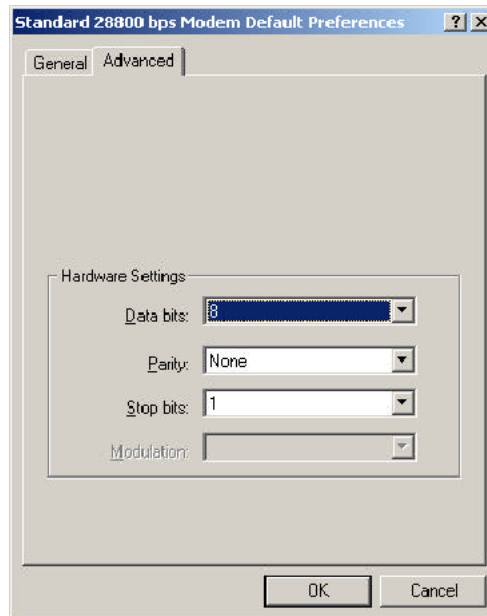

- Click **OK** until all dialog boxes are closed. This will setup your Windows driver so **DirectSOFT32** can use the Windows TAPI control when accessing the modem.

Configuring the Link

With the modem configured correctly, the link to the PLC can now be established. The next series of steps will provide the information necessary for configuring the link using *DirectSOFT32*.

1. The LinkWizard can automatically determine the majority of the communication settings; however, you will need to manually setup the modem specific information (modem type, phone number, etc.). To activate the Link Wizard in the Launch Window, right click on the **Comm Links** icon in the **DSLlaunch** tree and select **Add Link**.

Right Click to
select Add Link

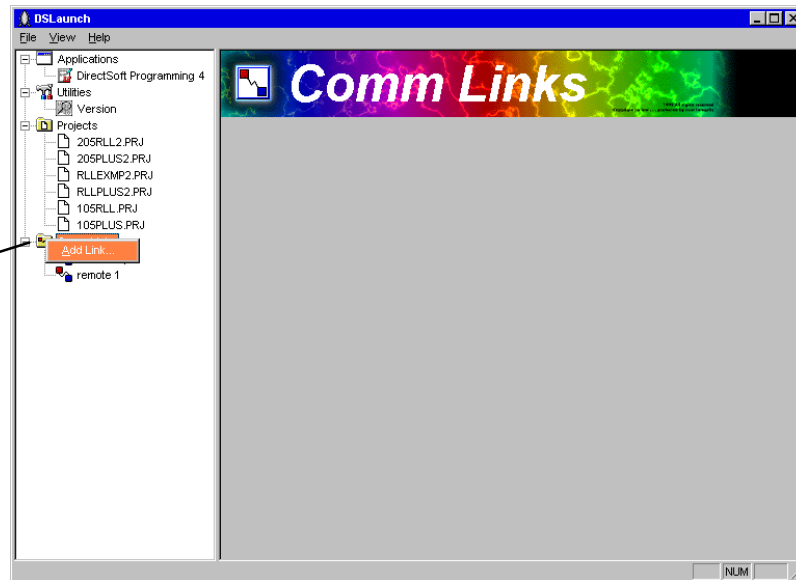

2. Select **Modem** as the device and click the **Next** button.

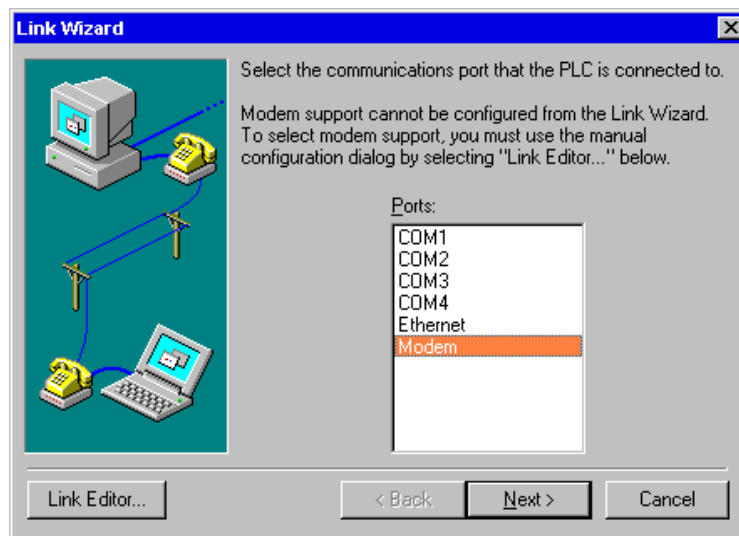

- The Configure Link dialog box should now be present. First, choose the PLC family and the PLC CPU Type. Click once on the appropriate item in the **PLC Family** and a list of available CPUs for that family will appear to the right. Click once to select the appropriate **PLC Type**. Also give the link a name and description.

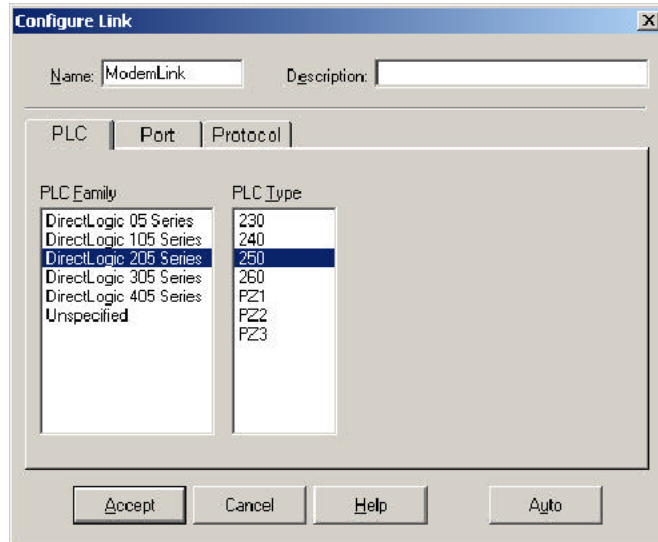

- Click the **Port** tab of the dialog to display the port configuration dialog. This dialog allows you to setup up the port to match your modem's configuration. Follow the steps below:
 - Select **Modem** in the **Devices** column.
 - Select the modem type that you configured earlier in this procedure. You can verify or modify the settings by clicking on the **Properties** button or you can create a new modem by clicking on the **Add** button.
 - Enter the dialing information for your modem.

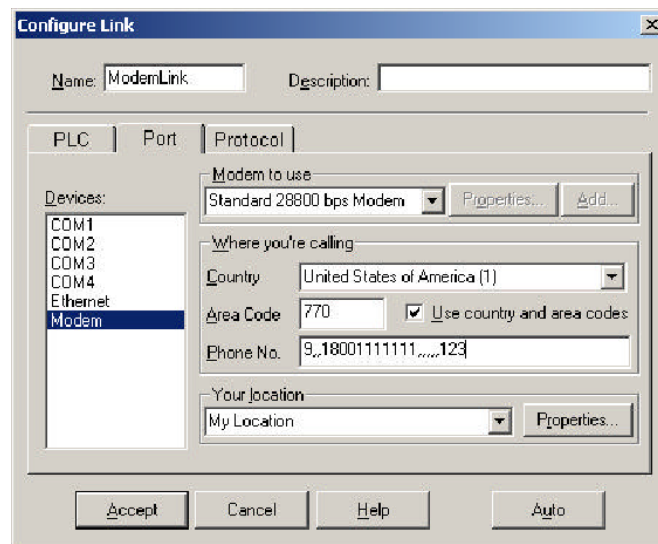

5. Click the **Protocol** tab to display the communication protocol dialog box. This dialog allows you to further define the communication parameters.

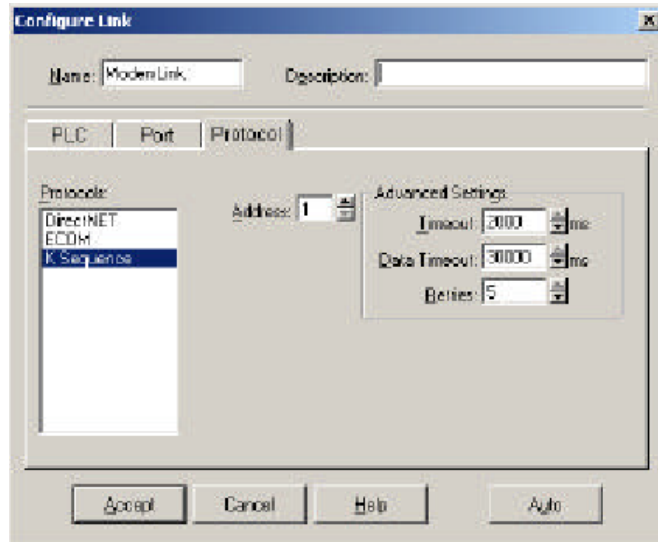

- Select the communication protocol to use. Refer to the chart in Appendix A for a breakdown of the various CPUs, and which protocols are supported on which ports.
 - If the PLC has been given a node **Address** other than 1, enter the new address now.
 - You can adjust the time-outs and retries on this dialog, however, the default values should work for you.
6. Click the **Accept** button to save this link configuration. The following dialog will appear. If you click **Yes**, **DirectSOFT32** will dial the modem and attempt to verify that it can communicate with the PLC connected to the other modem using the parameters defined in the link. **DirectSOFT32** will hang-up once the connection is made. If you click **No**, the link configuration will simply be saved to disk.



- After successfully creating a link, the Launch Window will have an entry for the link that you have created. The name that you assigned to the link should appear in the menu tree under the **Comm Links** icon. If the link is highlighted, the main launch window screen will change with all of the links information displayed.

