



Errata Sheet

This Errata Sheet contains corrections or changes made after the publication of this manual.

Product Family:	DL205 / DL305	Date:	September 2018
Manual Number	D2-DCM		
Revision and Date	2nd Edition; February 2003		

Change to Table of Contents

There is a typo on the first page of the Table of Contents. "Install" is spelled "Insall" for the section named "Install the D2-DCM".

Change to Page 2. Introduction

Add the following note to this page:

NOTE: The D3-DCM module is only supported by the D3-350 processor only.

Change to Page 7. Specifications

In the Operating Specifications table, revise the "CPU Required" entry. It should say:

D2-240 (firmware V1.8 or later), D2-250-1 and D2-260

Change to Page 11. Building the Cable

The NOTE at the bottom of the page is incorrect. Only the D2-230 and D2-240 CPUs support RS232 only. D2-250(-1) and D2-260 CPUs support RS232/422/485 without extra hardware.

Change to Page 12. Building the Cable (continued)

Change the reference in the first paragraph to "Belden 9855" cable to "AutomationDirect L19772-1 (Belden 8102) or equivalent".

Change to Page 13. Building the Cable (continued)

In the first paragraph, change the last sentence to "For example, AutomationDirect L19772-1 (Belden 8102) or equivalent has a nominal characteristic impedance of 100 ohms".

In the top wiring drawing ("Line-to-Line Termination for the D2-DCM"), change both "120 Ohm Resistor" callouts to "100 Ohm Resistor".

In the bottom wiring drawing, change the "65 Ohm Resistors" callouts to "51 Ohm Resistors".

In the top drawing, move the termination resistor on the left connector (Master) from the 24-25 pins to the 16-17 pins.



Errata Sheet

This Errata Sheet contains corrections or changes made after the publication of this manual.

The Change to Page 17. D2–DCM Switch Settings

Add the following note near the first bullet point, “*Direct*NET Slave”:

NOTE: Although it is not listed in the switch settings, K-sequence is also available whenever the D2–DCM is set for DirectNET Slave operation.

Change to Page 18. D2–DCM Switch Settings (continued)

There is an error in the last paragraph, “Response Delay Time”. The first sentence refers to switch “SW4”. It should say “SW5”. (SW4 is used for firmware updates.)

Change to Page 21. Install the D2–DCM and Starting the Network

Add the following note to this page:

D3-DCM cannot be mounted in the farthest slot from the CPU in a base. It requires 300 mA of +9 V base power. Make sure you will not exceed the available base power budget by installing the D3-DCM.

See the DL305 User Manual for complete details on power budget calculations.

Changes to Appendix A. Cable Diagrams

Page A-4. Point-to-Point RS422 D2–DCM as Master

In the lower left drawing there are some pin number errors for the DL405 port 1 25-pin connector. The correct pin numbers are:

19 +RTS (not 10 as shown)

18 -RTS (not 11 as shown)

11 +CTS (not 12 as shown)

23 -CTS (not 13 as shown)

In the top set of drawings, change the callout that says “DL405 CPU Bottom Port” to DL405 Port 1”



Errata Sheet

This Errata Sheet contains corrections or changes made after the publication of this manual.

Change to Appendix A. Cable Diagrams (continued)

Page A-7. Revisions were made to both drawings:

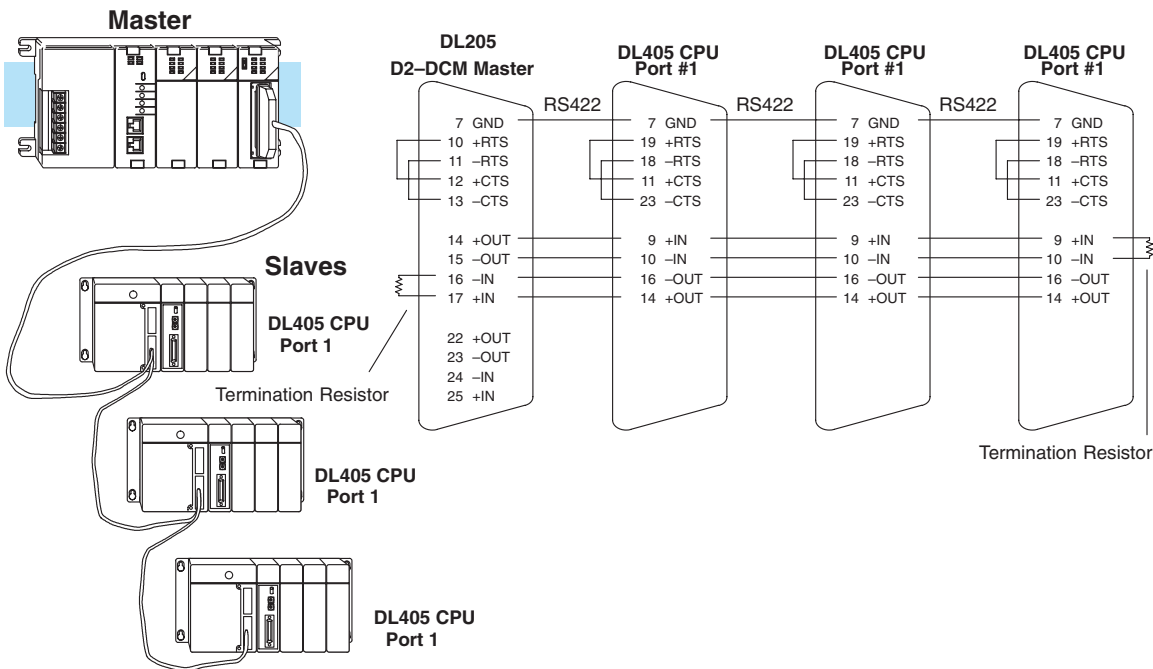
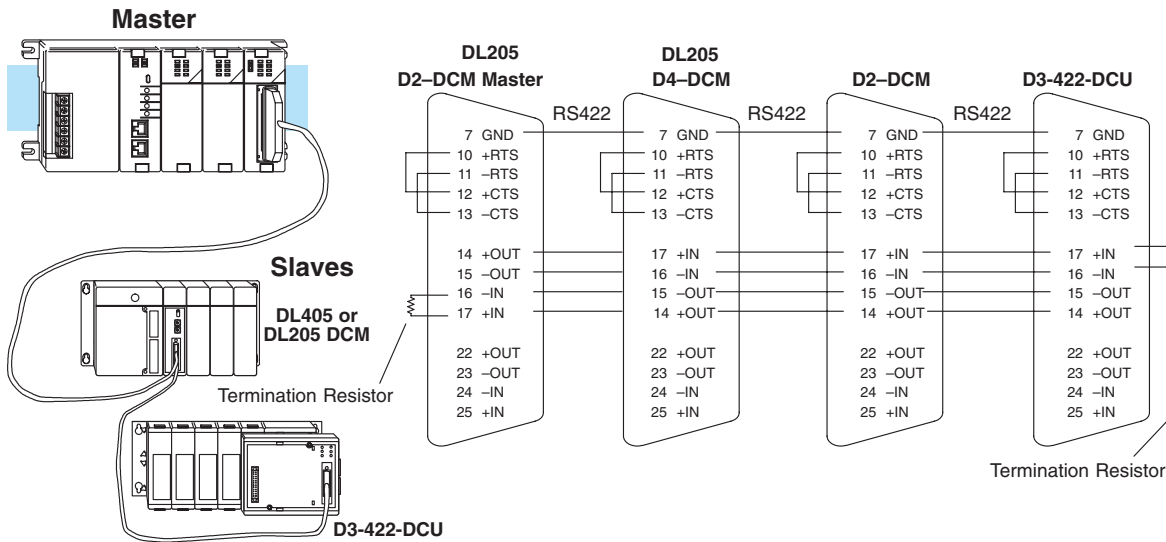

Change to Appendix A. Cable Diagrams (continued)

Page A-8. Change the call-out that says "DL240 CPU Bottom Port or DL450 Phone Jack" to: "DL450 Port 2 (RJ12)"

D2–DCM

Data Communication

Module

In This Manual. . . .

- Introduction
- Building the Communication Cable
- Setting the D2–DCM Switches
- Installing the D2–DCM and Starting the Network
- Verification and Troubleshooting

Overview

The D3-DCM module is only supported by the D3-350 processor only.

The Purpose of this Manual

This manual is designed to allow you to setup and install your DL205 Data Communications Module (D2-DCM). This is the only manual you will need if you are using the D2-DCM as an extra general purpose communication port for your DL205 PLC system. If you plan on using the D2-DCM as a network master or slave for a **DirectNET** network, this manual covers the basic steps for setting up the D2-DCM and the RX/WX instructions needed in your RLL program.

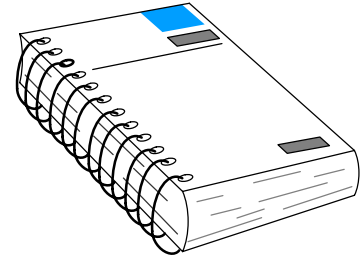

If you plan on using a personal computer as the network master, it may be helpful to read the **DirectNET** manual first. In either case, the **DirectNET** manual can be useful because it provides detailed descriptions of network configurations, various cable connections, etc.

Supplemental Manuals

Depending on which products you have purchased, there may be other manuals that are necessary or helpful for your application. These are some suggested manuals:

User Manuals

- **DirectNET** Network Guide part number DA-DNET-M
- **DirectSoft32** Programming Software part number PC-DSOFT32-M

If you plan to use your D2-DCM to communicate with another PLC, you will need the appropriate user manual for the other PLC.

If you plan to use your D2-DCM module as an interface to HMI or PC Control software or to an Operator Interface panel, you will need to refer to the documentation for that product.

Who Should Read this Manual

If you need an additional communications port for your DL205 PLC and you understand the basics of installing and programming PLCs, this is the right manual for you. This manual gives you the information you need to set up an active port on the D2-DCM module.

Technical Support

We strive to make our manuals the best in the industry and rely on your feedback in reaching our goal. If you cannot find the solution to your particular application, or, if for any reason you need additional technical assistance, please call us at

770-844-4200.

Our technical support team is glad to work with you in answering your questions. They are available **weekdays from 9:00 a.m. to 6:00 p.m. Eastern Time**. We also encourage you to visit our website where you can find technical and nontechnical information about our products and our company.

www.automationdirect.com

Conventions Used



The “light bulb” icon in the left-hand margin indicates a **tip** or **shortcut**.



The “note pad” icon in the left-hand margin indicates a **special note**.

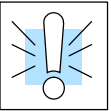

The “exclamation mark” icon in the left-hand margin indicates a **warning** or **caution**. These are very important because the information may help you prevent serious personal injury or equipment damage.

Key Topics for Each Chapter

The beginning of each chapter will list the key topics that can be found in that chapter.

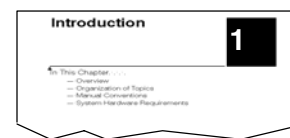

D2-DCM Hardware

The following diagram shows the major D2-DCM components. The address selection switches and the communication dipswitches are of special importance.

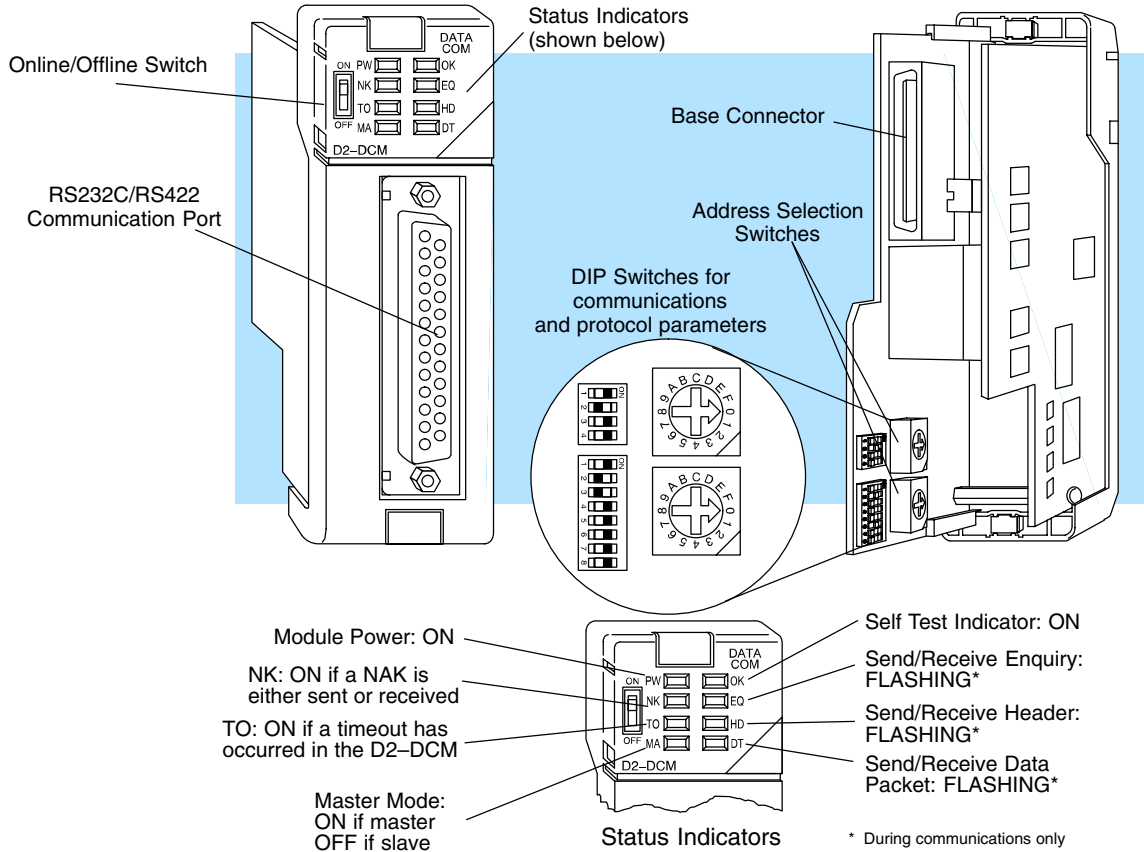

The DL205 Data Communications Module (D2-DCM) is a general purpose communications interface that can be used in a DL205 system that has a D2-240/250-1/260 Central Processing Unit (CPU). **The D2-DCM cannot be used with a DL230 CPU.** The module can go in any base slot, except for Slot 0, which is next to the CPU. This module is primarily used for three reasons.

- As a network master or slave interface to a **DirectNET** network
- As an extra general purpose communications port to connect a personal computer or operator interface
- As a network interface to a MODBUS[®] network using the RTU protocol

Applications

As a *DirectNET* Interface

The D2-DCM can be used as a network interface for applications that require data to be shared between PLCs, or between PLCs and an intelligent device (such as a host computer). The D2-DCM can be configured as either a master or slave station and allows you to upload or download virtually any type of system data including Timer/Counter data, I/O information, and V-memory information.

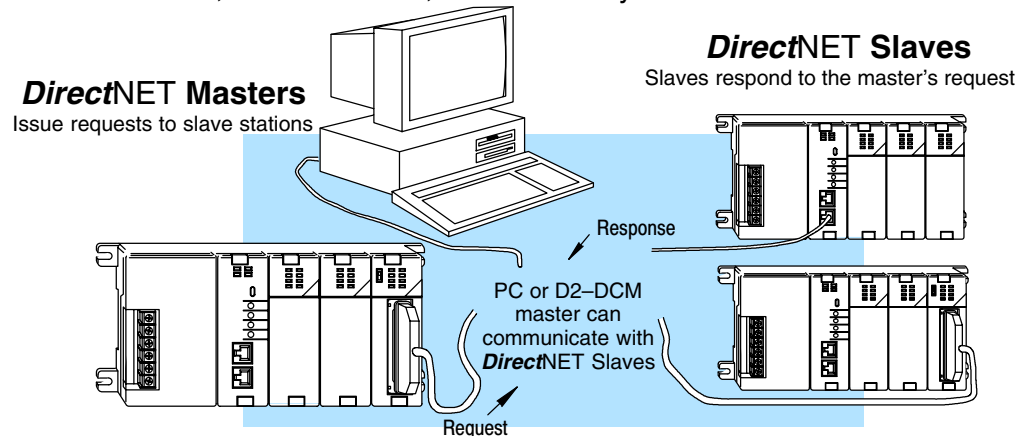

Using a D2-DCM as a Network Master

The DL205 D2-DCM can be used with a D2-240/250-1/260 CPU to serve as a network master. Your CPU must have firmware V1.8 or later. **It cannot be used with a DL230 CPU.** (A master is the network station that *initiates* requests for data from other stations on the network). You simply use special RLL instructions (RX and WX) inside of your RLL program to initiate the data exchange. The D2-DCM takes communication requests issued by the PLC program instructions and automatically converts these requests into network commands that read data from or write data to another network station.

The PLC program is really very simple and only requires a few instructions. Appendix A provides an overview of the instructions. Or, see the *DirectNET* Manual for network details.

Using a D2-DCM as a Network Slave

The D2-DCM can also be used with a D2-240/250-1/260 CPU to serve as a network slave station. **It cannot be used with a DL230 CPU.** In this case, the D2-DCM “listens” to the network for any messages that contain the D2-DCM’s address. The D2-DCM deciphers the network commands, carries out the request to read or write data, and sends confirmation and/or information to the master station.

Possible Slaves

- D2-240/250-1/260 CPU (bottom port)
- D2-240/250-1/260 w/ D2-DCM
- D3-330 or D3-330P w/ DCU
- D3-340 (either port)
- D4-430 (bottom port)
- D4-440 (bottom port)
- D4-450 (phone jack or bottom port)
- Any DL405 CPU w/ D4-DCM

Possible Masters

- D2-240/250-1/260 w/ D2-DCM
- D3-340 CPU (bottom port)
- Any DL405 CPU w/ D4-DCM
- D4-450 CPU (bottom port)
- Host computer w/*DirectSOFT* DSData Server

As an Extra Communication Port

As an extra communication port, the D2-DCM supports the **DirectNET** protocol just like the bottom port on the D2-240/250-1/260 CPU, but at higher baud rates. In general, if you can connect a device to the bottom port on the D2-240/250-1/260 CPU, then you can also connect the same device to the D2-DCM. These devices can be a variety of things, such as operator interfaces or personal computers.

Since the D2-DCM does not require any programming, you can simply set the D2-DCM communication parameters, connect the appropriate RS232C or RS422 cables, and start transferring data.

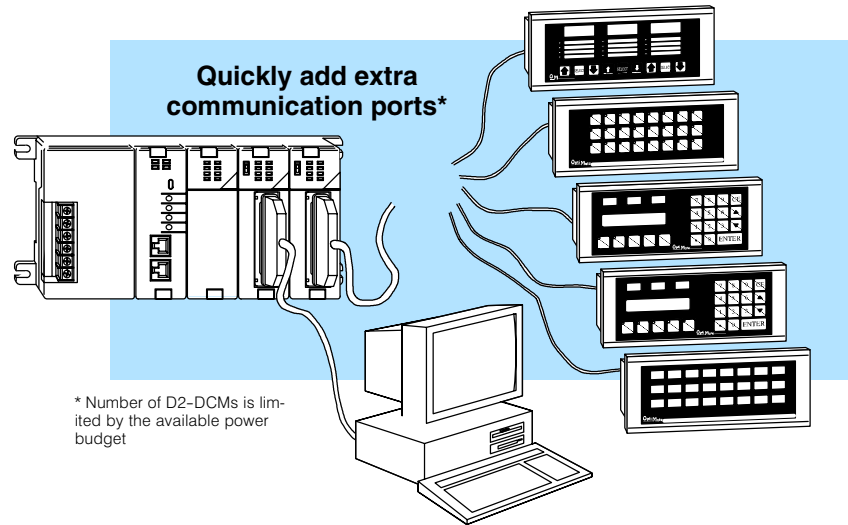

As a MODBUS® Network Interface

The D2-DCM can be used as a slave interface to connect your DL205 system to a MODBUS® network using the MODBUS® RTU protocol. The host system must be capable of issuing the MODBUS® commands to read or write the appropriate data. **Appendix C provides additional information on using the D2-DCM as a MODBUS slave interface.** This manual does not describe the MODBUS® protocol. We recommend that you reference the Gould MODBUS® Protocol Reference Guide (P1-MBUS-300 Rev. B) for details on the protocol. There may be more recent editions of this manual, so check with your MODBUS® supplier before ordering the documentation.

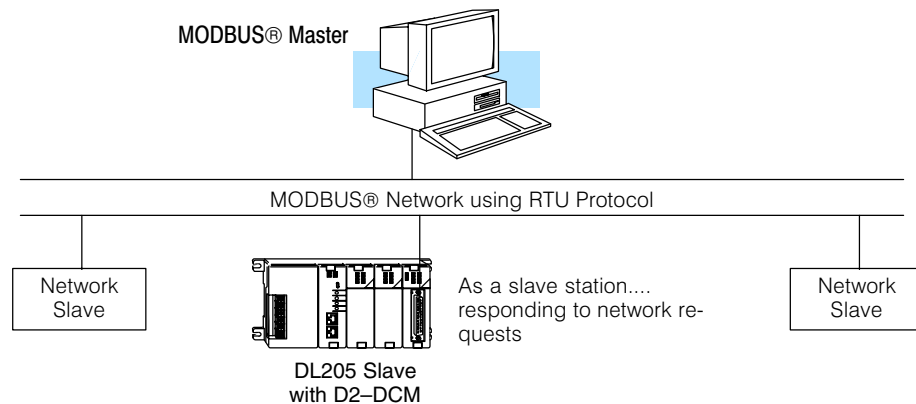

Specifications

Environmental Specifications

Operating Temperature	32° F to 131° F (0° to 55° C)
Storage Temperature	-4° F to 158° F (-20° to 80° C)
Operating Humidity	5 to 95% (non-condensing)
Air Composition	No corrosive gases permitted
Vibration	JIS C0040
Shock	JIS C0041
Voltage Isolation	1500 VAC, 1 minute duration
Insulation Resistance	10M ohms at 500 VDC
Noise	NEMA ICS3-304

Operating Specifications

Power Budget Requirement	300ma @ 5 VDC
Maximum number of modules	limited only by power budget
CPU Required	D2-240/250-1/260 minimum firmware V1.8 or later
Location of module	CPU base only any slot except Slot 0 or CPU slot
Interface	Serial RS232C / RS422 half-duplex, DTE, Asynchronous, 8 bits/character, odd or no parity
Baud Rates	300 to 38.4K baud, switch selectable
Maximum Distance	RS232C – 49ft (15 meters) RS422 – 3300 feet (1000 meters)
Protocol	DirectNET ¹ K-sequence (proprietary) MODBUS [®] RTU
Diagnostics	Automatic check of ROM/RAM, communications, switch settings, and LEDs

D2-240 (firmware V1.8 or later), D2-250-1 and D2-260

Note 1: Also compatible with Hostlink and/or CCM2 protocols. These names were used by previous vendors of compatible Koyo designed products.

Using your D2-DCM– Five Steps

STEP 1. Familiarize yourself with the communications options of D2-DCM in the Introduction.

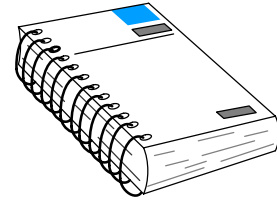

STEP 2. Build the communication cable that fits your needs.

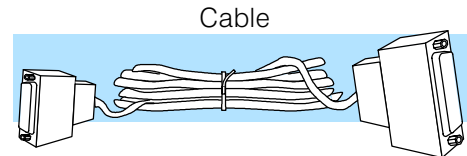

STEP 3. Set the D2-DCM switches. (Baud rate, parity, etc).

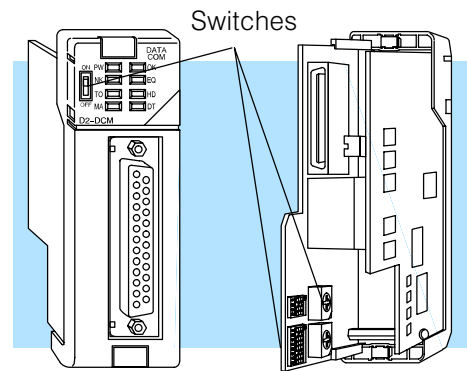

STEP 4. Install the D2-DCM in any slot except for Slot 0, which is next to the CPU.

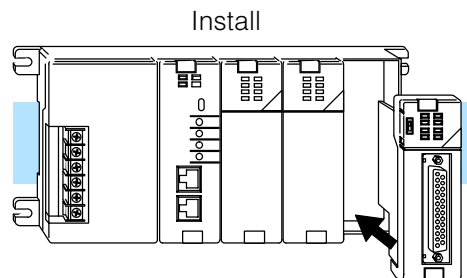

STEP 5. Verify correct network operation by using the indicators and the troubleshooting chart.

