

PRODUCT DESCRIPTION:

KEY

PRODUCT CODE:

KEY4

DYNAMIC 3D VIEW:

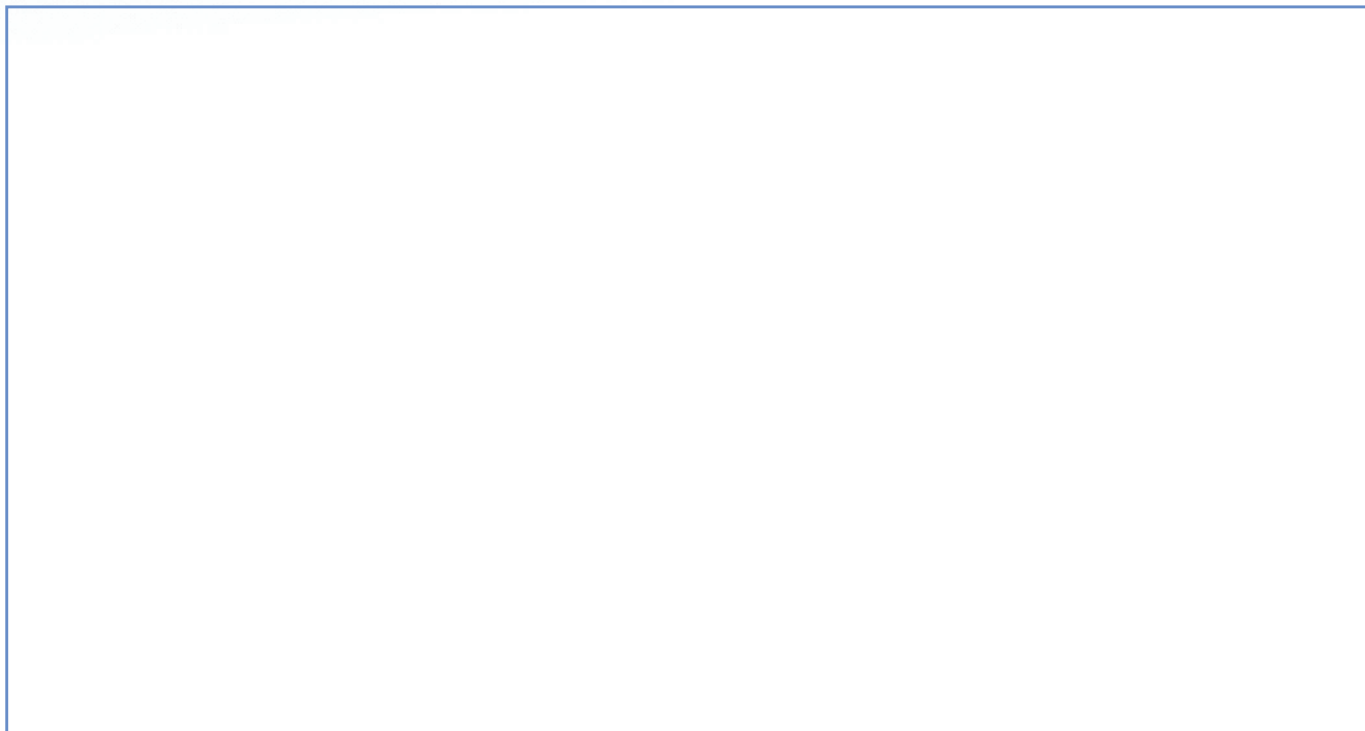

STATIC 3D VIEW:



TECHNICAL VIEW:

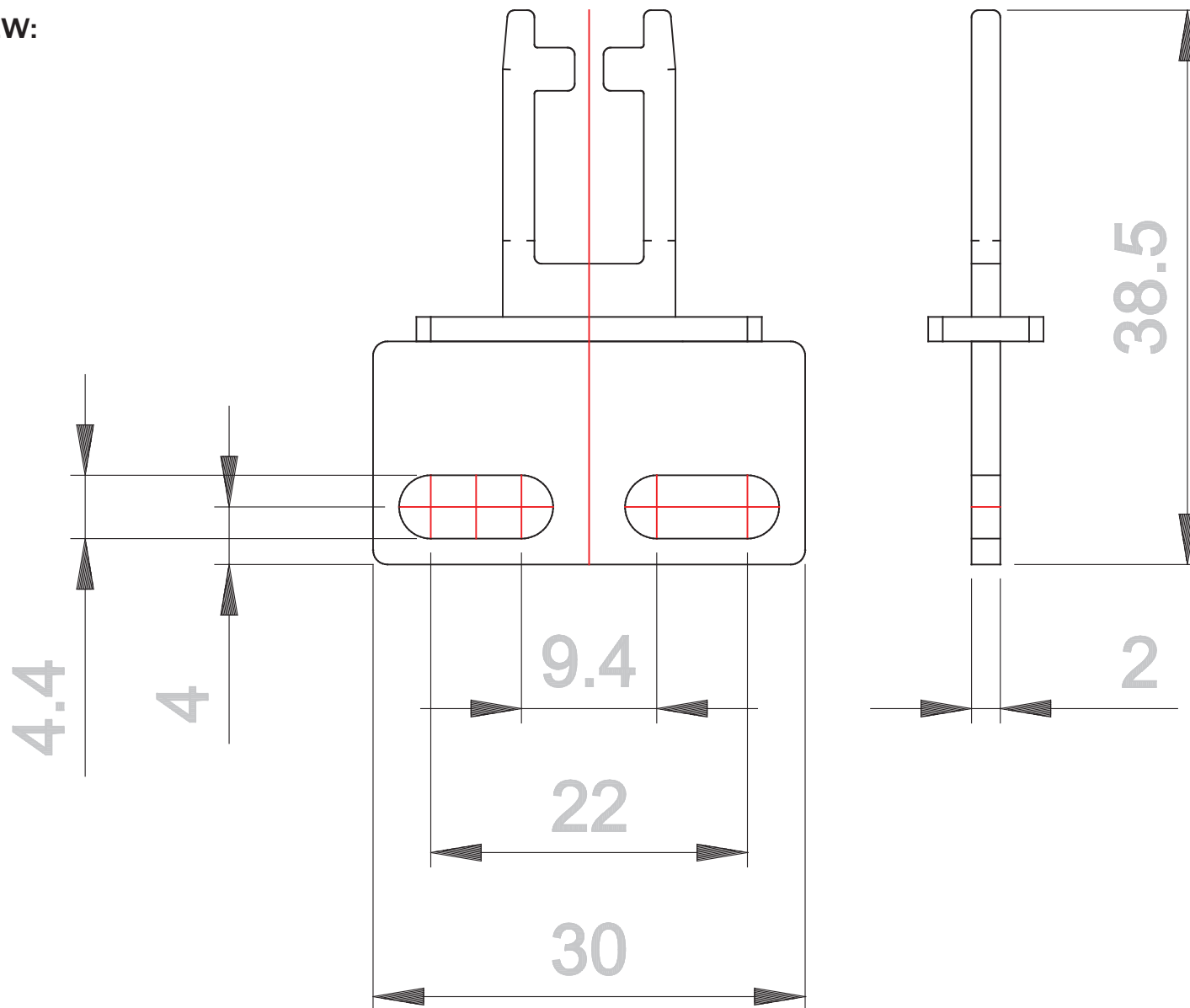

DETAILS:

Code	KEY4
Description	Flat key
Material	stainless steel
Mounting	Using two fixing holes
IP Degree of Protection	/
Compatible product series	K10, K80

PRODUCT DRAWING RELEASE:

Datasheet creation date: 23/01/2023 11:48

Last Modification (geometry): 08/02/2022 09:17

tel. +39 039 9906408
+39 039 9903468
fax +39 039 9906203Via Novarino 9/L
23899 Robbiate (LC)
ITALYwww.comepi.it
comepi@comepi.it
tecnico@comepi.it