





REPLACEMENT PARTS



CONTENTS OF THIS CHAPTER

<i>Replacement Parts Overview</i>	9-2
<i>Panel Mounting Clip Replacements</i>	9-3
<i>HMI-BRK-1</i>	9-3
<i>HMI-BRK-2</i>	9-3
<i>Logo Label Insert - HMI-LOGO-LBL</i>	9-4
<i>3-wire Communications Terminal Block - HMI-3TB</i>	9-5
<i>DC Power Terminal Block - C0-4TB</i>	9-5
<i>Panel Gasket - HMI-xW-GSK</i>	9-6
<i>Gasket Replacement Installation Instructions:</i>	9-6

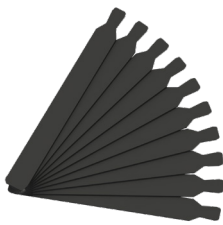
REPLACEMENT PARTS OVERVIEW

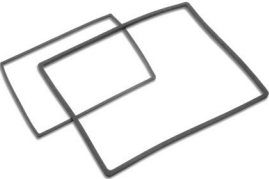
Part Number		Description
<u>HMI-BRK-1</u>		C-more panel mounting brackets, replacement. Package of 2. For use with C-more CM5-T4W 4in HMI.
<u>HMI-BRK-2</u>		C-more panel mounting brackets, replacement. Package of 8. For use with C-more CM5 series 7in, 10in, 12in, 15in and 22in HMIs.
<u>HMI-LOGO-LBL</u>		C-more blank label insert, replacement. Package of 10. For use with C-more CM5 series HMI front bezel.
<u>HMI-3TB</u>		C-more pluggable terminal block, replacement, 3-pole. Package of 2. For use with 3-wire RS-485 communications port on C-more CM5 series HMIs.
<u>CO-4TB</u>		CLICK terminal blocks, replacement, 4-pole. Package of 2. For use with CLICK PLCs.
<u>HMI-4W-GSK</u>		C-more panel mounting gasket, replacement. For use with C-more CM5-T4W 4in HMI.
<u>HMI-7W-GSK</u>		C-more panel mounting gasket, replacement. For use with C-more CM5-T7W 7in HMI.
<u>HMI-10W-GSK</u>		C-more panel mounting gasket, replacement. For use with C-more CM5-T10W 10in HMI.
<u>HMI-12W-GSK</u>		C-more panel mounting gasket, replacement. For use with C-more CM5-T12W 12in HMI.
<u>HMI-15W-GSK</u>		C-more panel mounting gasket, replacement. For use with C-more CM5-T15W 15in HMI.
<u>HMI-22W-GSK</u>		C-more panel mounting gasket, replacement. For use with C-more CM5-T22W 22in HMI.

PANEL MOUNTING CLIP REPLACEMENTS

Replacement panel mounting clips are available for **C-more** CM5 Series panels.

HMI-BRK-1

HMI-BRK-1 mounting clips fit CM5-T4W. Two clips per package with screws.



HMI-BRK-2

HMI-BRK-2 mounting clips fit CM5-T7W, CM5-T10W, CM5-T12W, CM5-T15W and CM5-T22W. Eight clips per package with screws.



MOUNTING CLIP INSTRUCTIONS

- 1) Position the touch panel through the cutout in the control cabinet door and hold in place. Position the mounting clips as appropriate for your model. Refer to Chapter 2.
- 2) Tighten the mounting screws in an alternating fashion while observing the front of the touch panel.

The goal is to make sure the front bezel is pulled up against the enclosure sheet metal uniformly, and the touch panel gasket is fully compressed all the way around its perimeter. Tighten the screws to a torque rating shown in the table below. Avoid over-tightening the screws to the point that they start to deform or bend the bezel or mounting clip.

Touch Panel Size	Enclosure Thickness Range	Mounting Clip Screw Torque	Material
4-inch	0.039 - 0.20 inch [1 - 5 mm]	21 - 28 oz-in [0.15 - 0.20 Nm]	Metal
7-inch through 22-inch		135 - 149 oz-in [0.95 - 1.05 Nm]	

LOGO LABEL INSERT - HMI-LOGO-LBL

C-more CM5 series panels include one customizable logo label. Additional logo labels can be purchased in packs of 10.

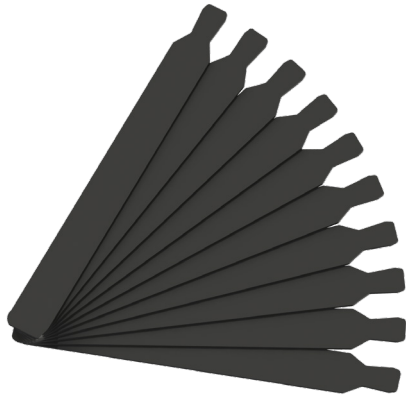

Removal- Insert small tool such as a jewelers screwdriver and pull tab away from housing.



Installation - Insert HMI-LOGO into the slot in the side of the panel and lock tab into place.

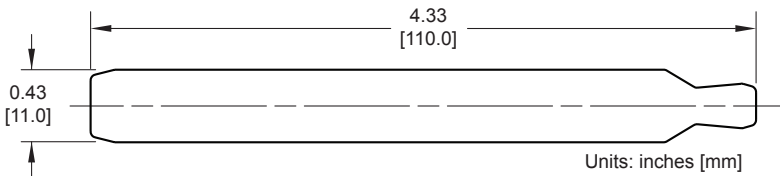
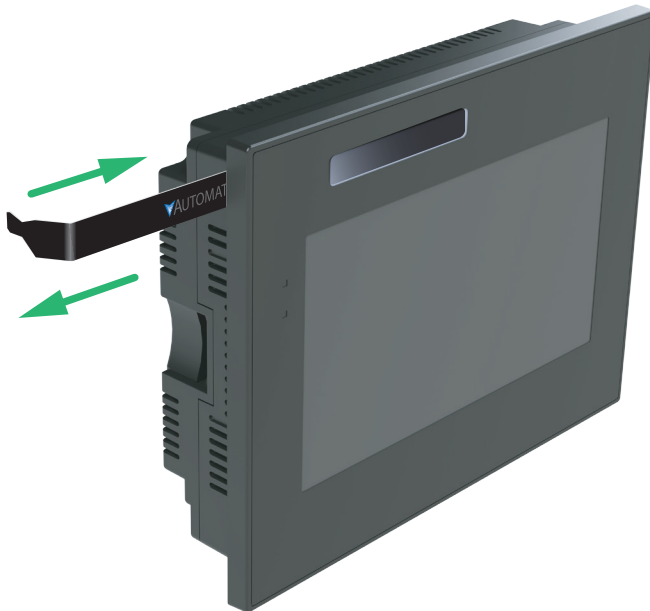

3-WIRE COMMUNICATIONS TERMINAL BLOCK - HMI-3TB

C-more CM5 series 3-wire communications terminal block replacement. Two (2) terminal blocks per package.



HMI-3TB Tightening Torque	
Cable torque	minimum 1.95 lb-in (0.22 Nm)

NOTE: Use 60 / 75 °C copper conductors only, 16 - 28 AWG

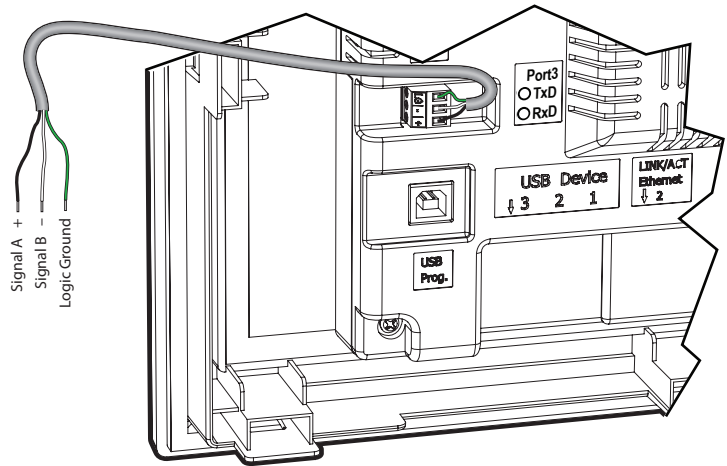

DC POWER TERMINAL BLOCK - C0-4TB

C-more CM5 series 4-wire DC power connector terminal block replacement. Two (2) terminal blocks per package.



C0-4TB Tightening Torque	
Power connector screw torque	35.4 oz-in (0.25 Nm)

NOTE: Use 60 / 75 °C copper conductors only, 16 - 24 AWG

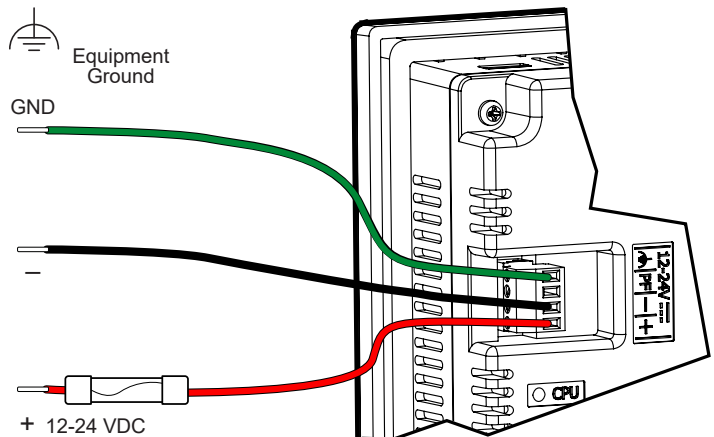

PANEL GASKET - HMI-xW-GSK

Replacement NEMA 4/4X touch panel gaskets for **C-more** CM5 series panels

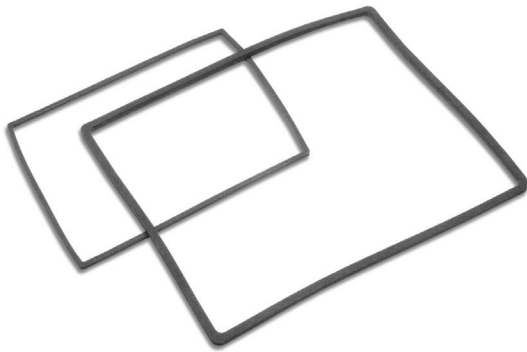

GASKET REPLACEMENT INSTALLATION INSTRUCTIONS:

Preparation: Disconnect input power and all other connections, then remove the touch panel from the control cabinet. In a clean environment, place the panel face down on a lint-free soft surface to prevent scratching the front of the panel.

Step 1

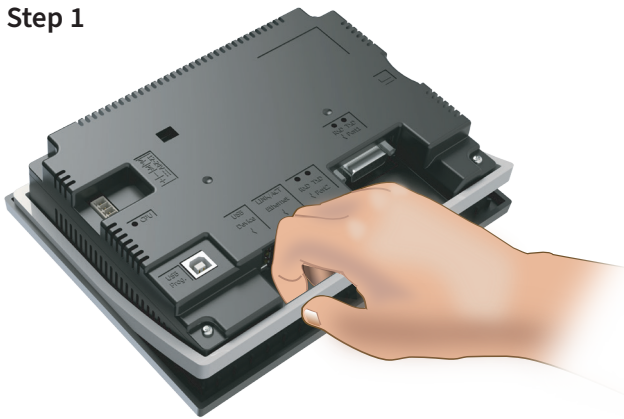

Start at one corner and pull the old gasket out of the channel that holds the gasket in place. Pull the gasket up as you work around the entire perimeter of the touch panel. Discard the old gasket.

Step 2

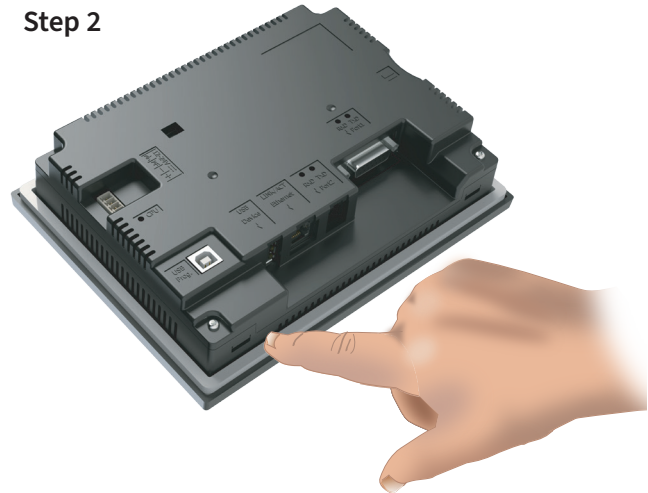

Lay the new gasket over the channel so that the long and short sides of the gasket match up to the long and short sides of the touch panel. Start at one corner and match the gasket's corner to the channel's corner. Press the gasket into the channel and work all away around the perimeter of the touch panel. Re-install the touch panel.