

series41 Standard Display



Product image



Dimensional drawing

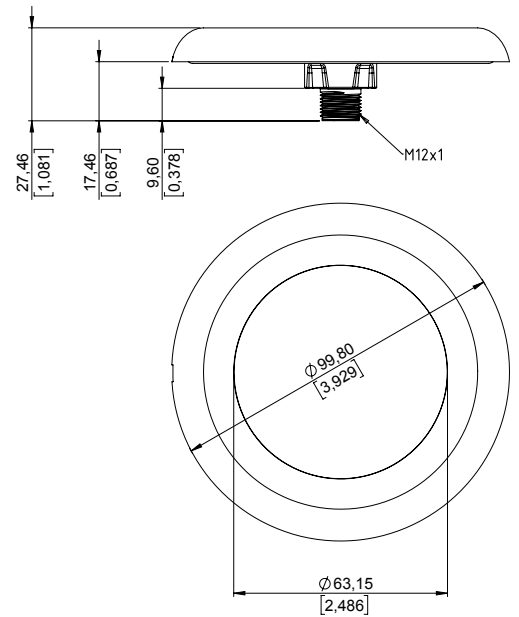

Connection plan

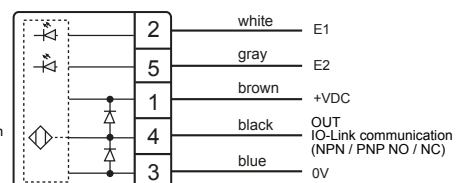
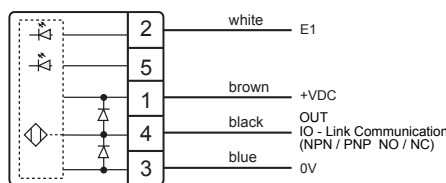
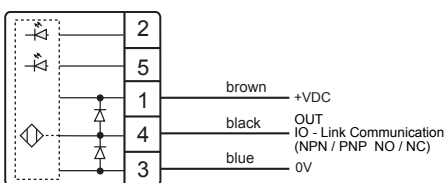

Plug

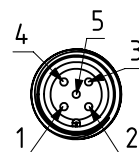
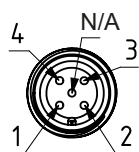
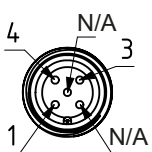

series41 Standard Display

Technical specifications

series41	
Operating voltage	DC 24 V (19,2...28,8 V)
Load current	Max. 200 mA
Reverse polarity protection	Protection of all cables/lines
Short circuit protection	Protected against short circuit and overload
Voltage drop	Max. 2,5 V bei 200 mA load current
Power consumption at 24 V	Max. 90 mA
Operating temperature	-25°C (-13°F)...+50°C (122°F)
Degree of protection IP	Front IP69K Maximum unevenness in mounting surface < 0,2 mm
Degree of protection IK	IK08
Communication interface	IO-Link specification V1.1
Measuring principle	Capacitive
Type of actuation	Touch
Actuation force	No actuation force required
Max. altitude	3000 m above sea level
Relative air humidity	Max. 95%, non-condensing