





Warnings and Cautions

Warning 	Dangerous Voltage Warning: warns of situations in which a high voltage can cause injury and/or equipment damage. The text next to this symbol describes ways to avoid danger.
Warning 	General Warning: warns of situations that can cause physical injury and/or equipment damage by means other than electrical. The text next to this symbol describes ways to avoid the danger.

General Safety Instructions

Warning 	Be sure to read, understand, and follow all safety instructions.
Warning 	Only qualified electricians should carry out all electrical installation and maintenance work on reactors.
Warning 	All wiring must be in accordance with the National Electrical Code (NEC) and/or any other codes that apply to the installation site.
Warning 	Disconnect all power before working on the equipment. Do not attempt any work on a powered reactor.
Warning 	The reactor, VFD, motor, and other connected equipment must be properly grounded.
Warning 	The VFD terminals and connected cables are at a dangerously high voltage when power is applied to the VFD, regardless of motor operation.

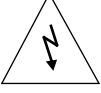
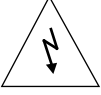
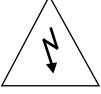
Torque Tables

Part Number	Terminal Torque	Ambient Temperature
LR-10P2-1PH	10 lb-in	40°C max
LR-10P5-1PH	10 lb-in	40°C max
LR-11P0-1PH	20 lb-in	40°C max
LR-20P5-1PH	10 lb-in	40°C max
LR-21P0-1PH	10 lb-in	40°C max
LR-22P0-1PH	20 lb-in	40°C max
LR-23P0-1PH	20 lb-in	40°C max

Part Number	Terminal Torque	Ambient Temperature
LR2-10P2-1PH	10 lb-in	40°C max
LR2-10P5-1PH	10 lb-in	40°C max
LR2-11P0-1PH	20 lb-in	40°C max
LR2-11P5-1PH	20 lb-in	40°C max
LR2-20P2-1PH	9 lb-in	50°C max
LR2-20P5-1PH	9 lb-in	50°C max
LR2-21P0-1PH	10 lb-in	40°C max
LR2-21P5-1PH	10 lb-in	40°C max
LR2-22P0-1PH	20 lb-in	40°C max

AutomationDirect

3505 Hutchinson Road
 Cumming, GA, USA 30040
 800-633-0405

Single-Phase Reactor Installation Guide

AutomationDirect

automationdirect.com

AutomationDirect

automationdirect.com

Single-phase Line Reactor

Installation Instruction

When installing the line reactor on the INPUT side of the Variable Frequency Drive (VFD), please use the following guidelines when wiring the unit:

The Line Reactor is a single-phase device and should be wired in series and positioned on the input side of the VFD.

Termination connections are illustrated on the product label. A1 and C1 are the input terminals where the incoming power is to be wired. As a result, A2 and C2 are the output terminals. In these cases, either the upper terminals or lower terminals can be used as the input terminals as long as the selection is consistent. For example, if an upper terminal is selected as the input, all upper terminals must be input terminals. Wiring from the output terminals should connect to the input of the VFD.

Refer to NEC wiring practices for appropriate wire sizes for your application.

Power Wiring: Only use 75°C copper conductors unless the wire connector is marked for Al/Cu, then the use of aluminum wire is permitted.

When applied to a 1-phase drive and 1-phase motor, and fed by 1-phase power, reactors are sized for the motor FLA.

When applied to a 3-phase drive and 3-phase motor, and fed by 1-phase power,

reactors are sized by the drive rated current or 173% of motor current.

In standard 40°C ambient or less installations, a clearance of 3 inches on all sides of the reactors and its enclosure is recommended for assisting in heat dissipation and ample wire bending space. This is a general guideline for typical applications. If the reactor is being installed next to a heat sensitive instrument or control device, we recommend reviewing specific requirements or heat limitations.

These reactors are designed to be floor-mounted or wall-mounted. Large open-style devices should be panel-mounted by incorporating a bracket that would act as a shelf to support the reactor and/or enclosure. When installing an open style device in an existing control cabinet, drive cabinet, motor control center, or other large enclosure, the reactor should be mounted in the lower half of the cabinet to prevent hot spots or pockets of heat (this typically allows better thermal dissipation and heat convection).

Din Rail Kit

Part Number	Description	Dimensions
LR2-DR1	35mm DIN Rail Mount for: LR2-20P2-1PH, LR2-20P2, LR2-20P5, LR2-40xx, LR2-41xx, LR2-42xx, LR2-43xx, LR2-51xx, LR2-52xx	Clips 1.8" x 0.6" Screws 10/32
LR2-DR2	35mm DIN Rail Mount for: LR2-20P5-1PH, LR2-20P7, LR2-21P0, LR2-21P5, LR2-22P0, LR2-44P0, LR2-45P0, LR2-47P5, LR2-53P0, LR2-54P0, LR2-55P0, LR2-57P5	4.25" x 4.13"

Adapter Plate Kit

Part Number	Description	Dimensions
LR2-AP1	Universal Mount for: LR2-20P2-1PH, LR2-20P2, LR2-20P5, LR2-40xx, LR2-41xx, LR2-42xx, LR2-43xx LR2-51xx, LR2-52xx	4.45" x 2.63"
LR2-AP2	Universal Mount for: LR2-20P2-1PH, LR2-20P2, LR2-20P5, LR2-40xx, LR2-41xx, LR2-42xx, LR2-43xx LR2-51xx, LR2-52xx	4.45" x 3.51"

Field Wiring Information

Below is the typical wiring diagram for the Single-phase reactor applied to the front end of the Variable Frequency Drive (VFD).

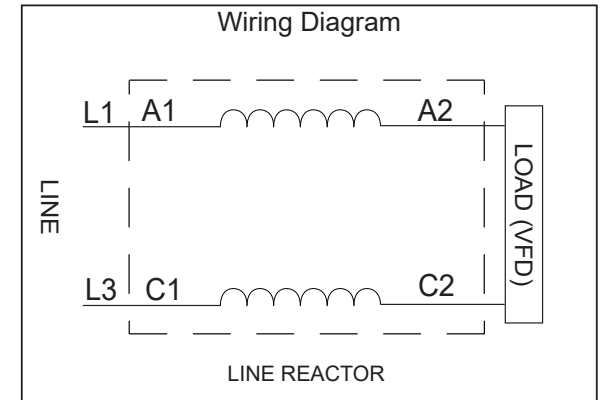

Line reactors with LR2 part numbers are supplied with B phase coils, no wires should be connected to terminals B1 and B2 for single phase applications.

Reactors should be wired and located as close to the front end of the VFD as possible to have the greatest success in both protecting the VFD as well as mitigating line harmonics.

Product Specifications

- Single-phase, 600 Volt Class
- UL Listed; File E197592
- CE Marked
- Current-rated device
- 200% rated current for 3 minutes
- Maximum Temperature Rise: 135°C