

PANEL CUTOUT DETAIL

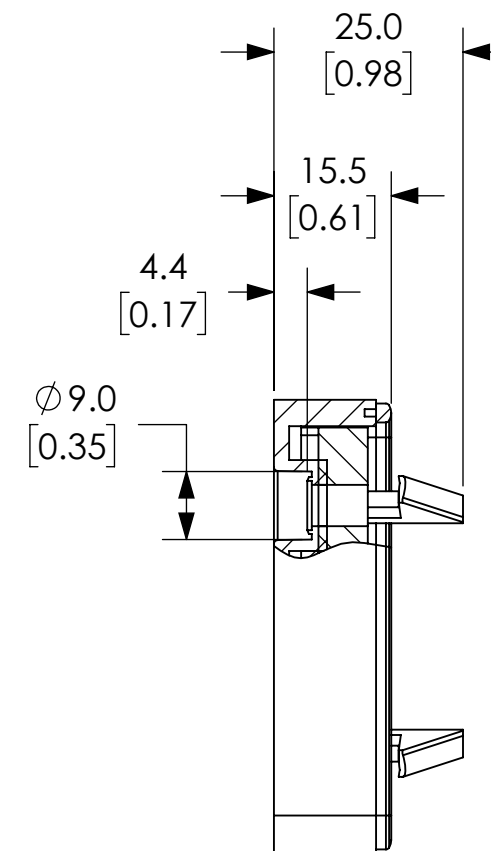
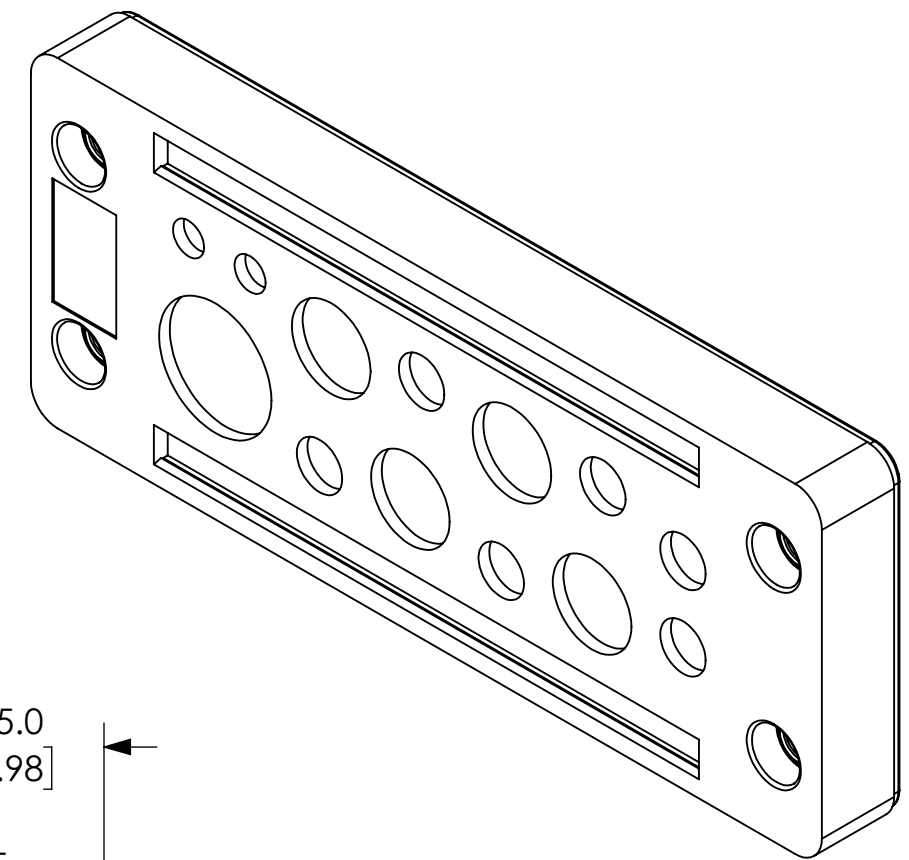
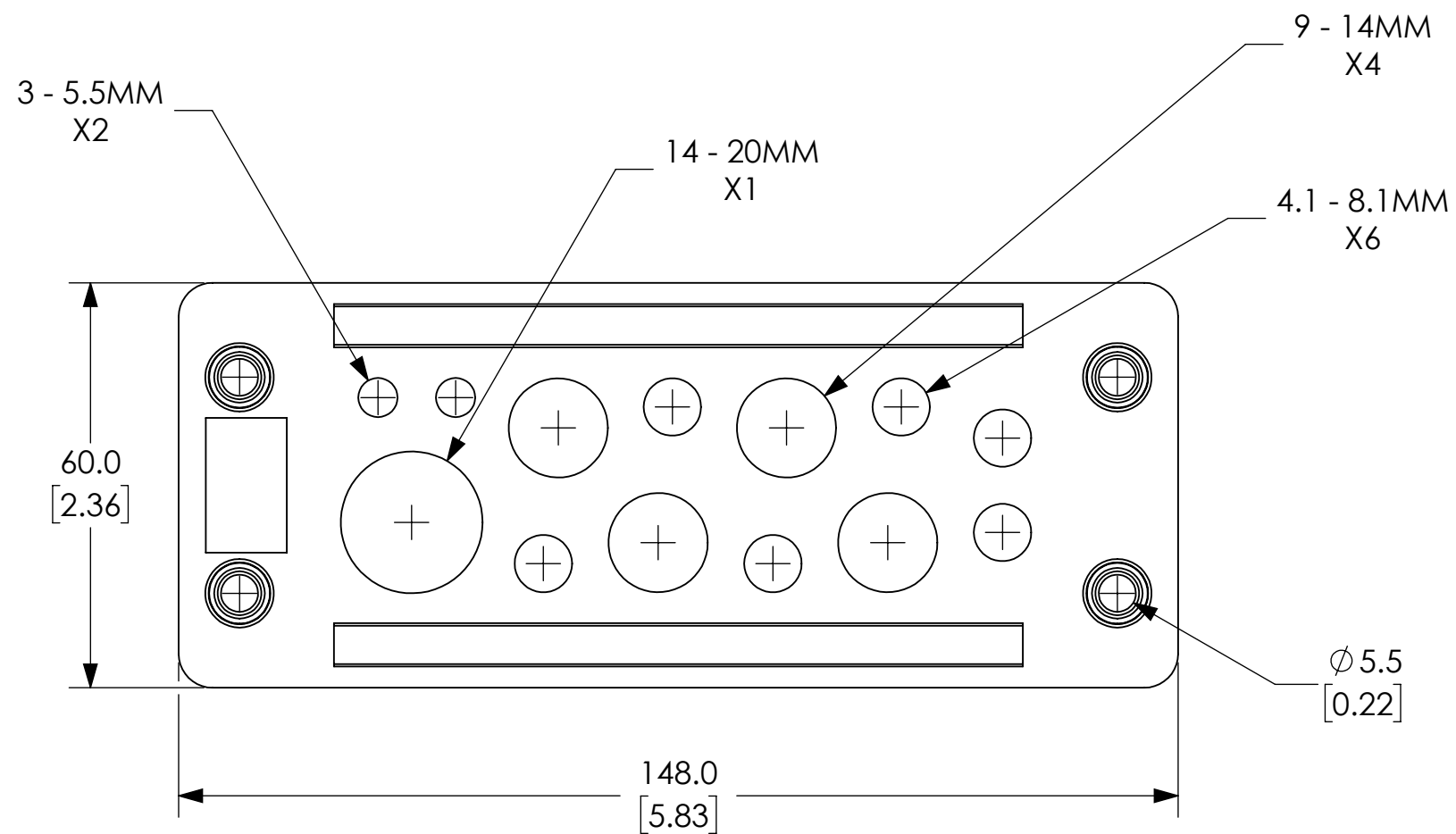

NOTES:

1. DIMENSIONS CAN BE CHANGED BY MANUFACTURER WITHOUT NOTICE.
2. DIMENSIONS DO NOT IMPLY TOLERANCE.

567335

Units: mm [inches]

Scale: Full

MURRPLASTIK KDP/X SERIES FRAME