

LASER SENTINEL FEATURES

- 1.) ETHERNET INPUT CONNECTOR (CONFIGURATION PC OR HOST)
- 2.) DIRECT MOUNTING HOLES (2)
- 3.) BRACKET MOUNTING HOLES (4)
- 4.-5.) I/O CONNECTORS (8+12 POLES OR 17+8 POLES, ACCORDING TO MODEL)
- 6.) ETHERNET OUTPUT CONNECTOR (TO SLAVES)
- 7.) DEVICE CLASS AND WARNING LABELS

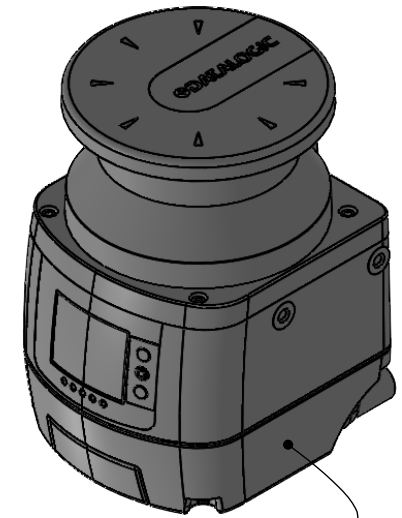

ISOMETRIC VIEW

7

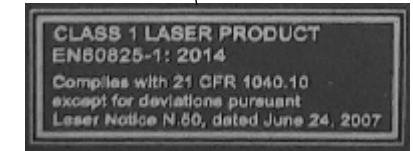
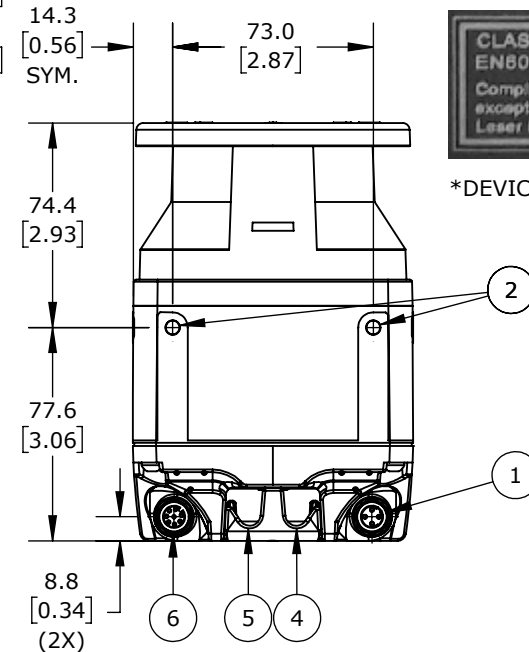
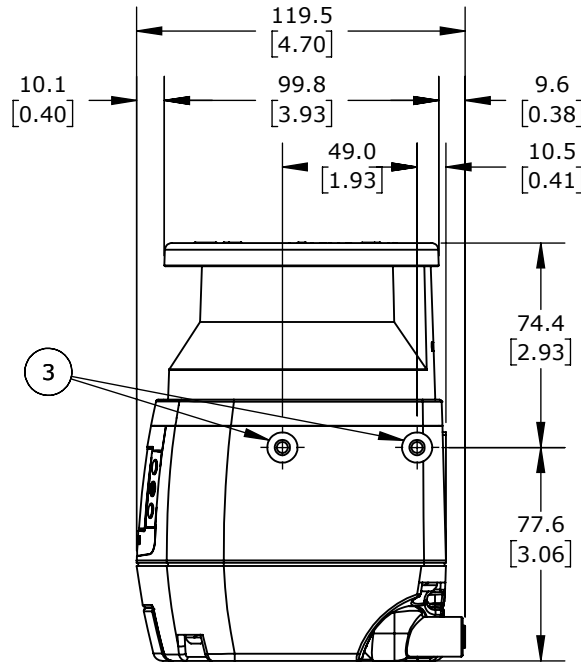
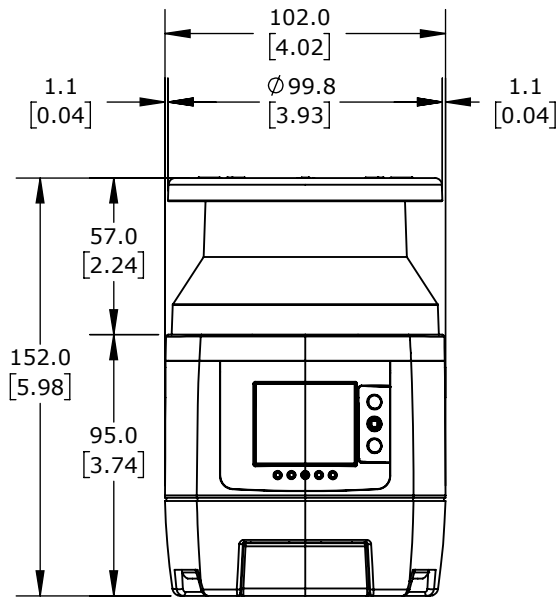

*DEVICE CLASS & WARNING LABEL

DATASENSING SLS MASTER REMOTE

SLS-M5-0812-E

AutomationDirect.com
1-800-633-0405

3rd ANGLE	NOT TO SCALE	PART DIMENSIONS MAY DIFFER SLIGHTLY DUE TO MANUFACTURER'S VARIANCES	METRIC UNITS USED FOR PART DESIGN	UNLESS OTHERWISE SPECIFIED UNITS ARE: mm [inch]	MODEL REV. --	DRAWING DATE 2/11/2026	SHEET 1 OF 1
-----------	--------------	---	-----------------------------------	--	---------------	------------------------	--------------