

SAGINAW CONTROL & ENGINEERING

SCE-SAHCB70T97

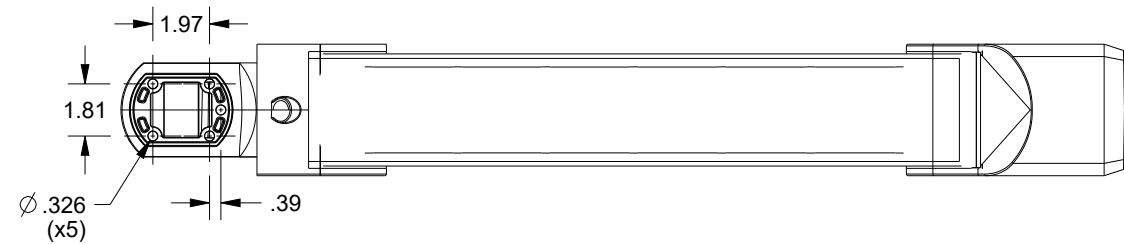
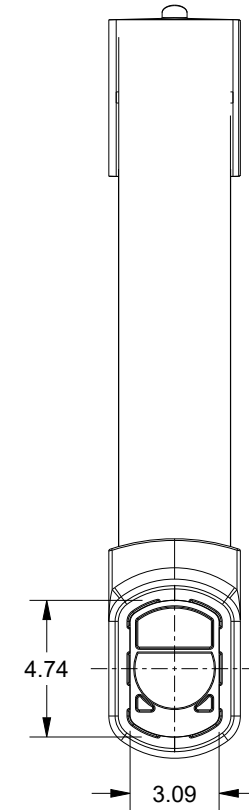
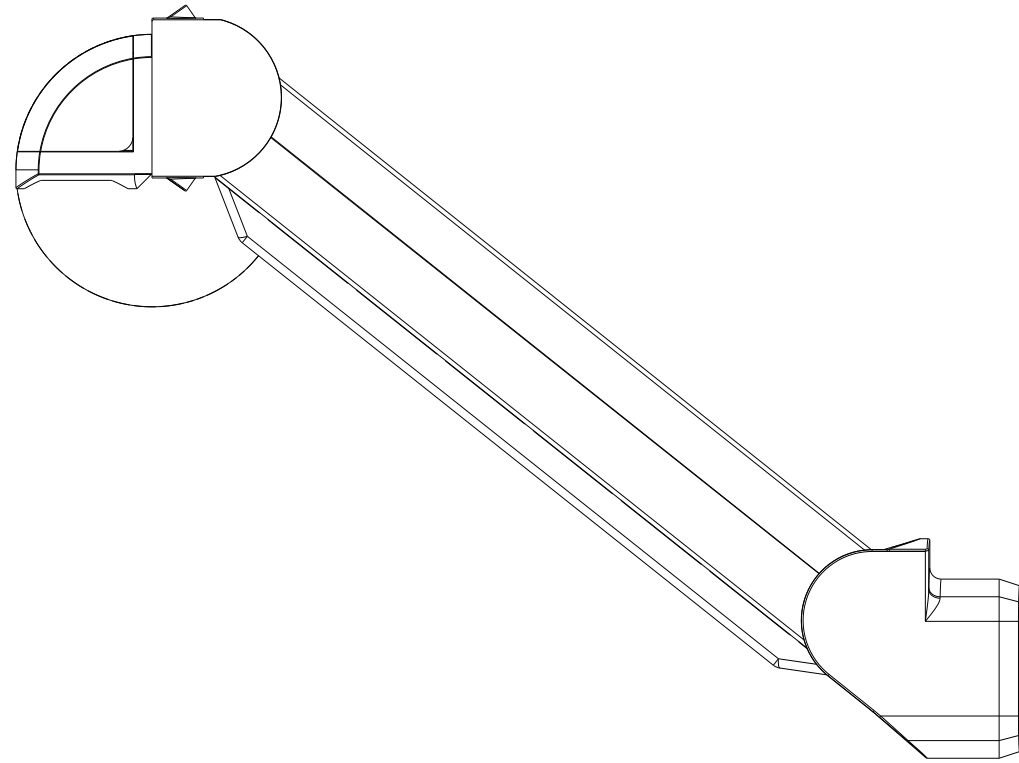
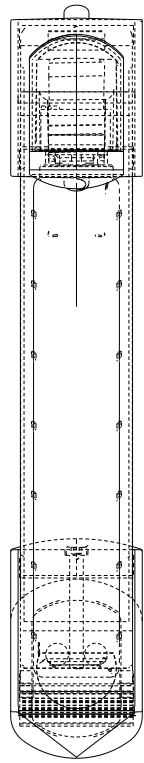
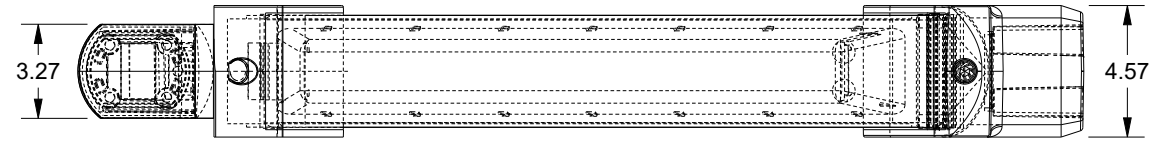

DESCRIPTION:
Suspension Arm Component - Counter Balance Arm -
70 to 97 lbs. 8.12 X 6.97 X 40.67 in. - Die Cast Aluminum -
RAL 7035 Gray