

SECTION A-A

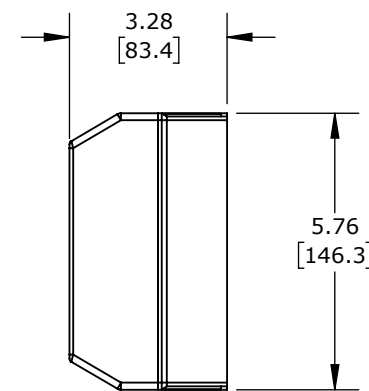
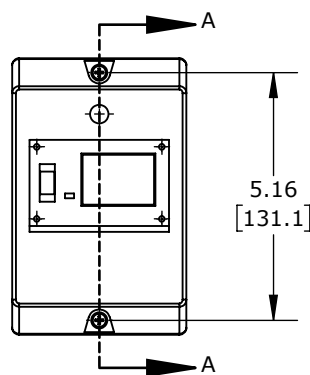

EASY TESYS SERIES ENCLOSURE WITHOUT MANUAL MOTOR PROTECTOR, 5.12 X 3.66 X 3.31IN, POLYCARBONATE, IP55. FOR USE WITH SCHNEIDER ELECTRIC GP2E01 TO GP2E32 MANUAL MOTOR PROTECTORS.

SCHNEIDER ELECTRIC MANUAL MOTOR PROTECTOR

GV2MC02

AutomationDirect.com
1-800-633-0405



3rd
ANGLE

NOT TO
SCALE

PART DIMENSIONS MAY DIFFER SLIGHTLY
DUE TO MANUFACTURER'S VARIANCES

INCH UNITS USED FOR
PART DESIGN

UNLESS OTHERWISE
SPECIFIED UNITS ARE:

inch
[mm]

LATEST VERSION
8/31/2023

SHEET 1 OF 1