

ISOMETRIC VIEW

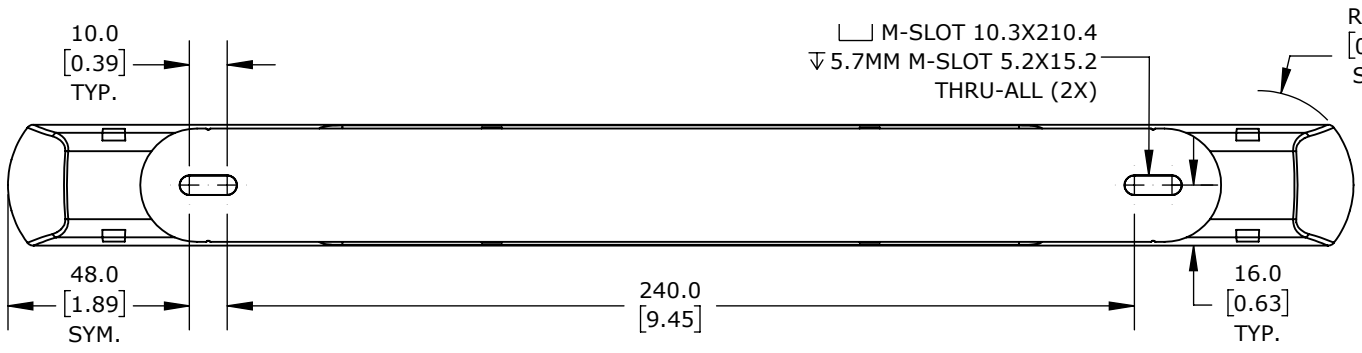
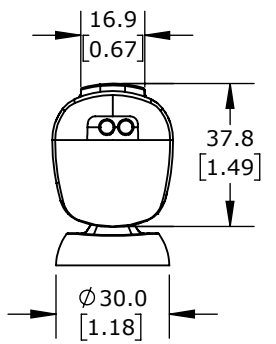
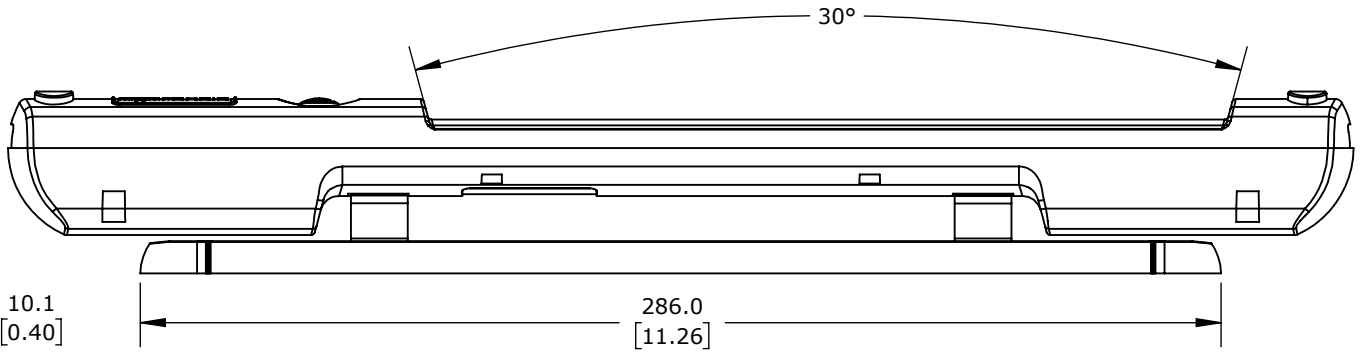
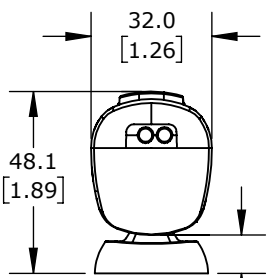
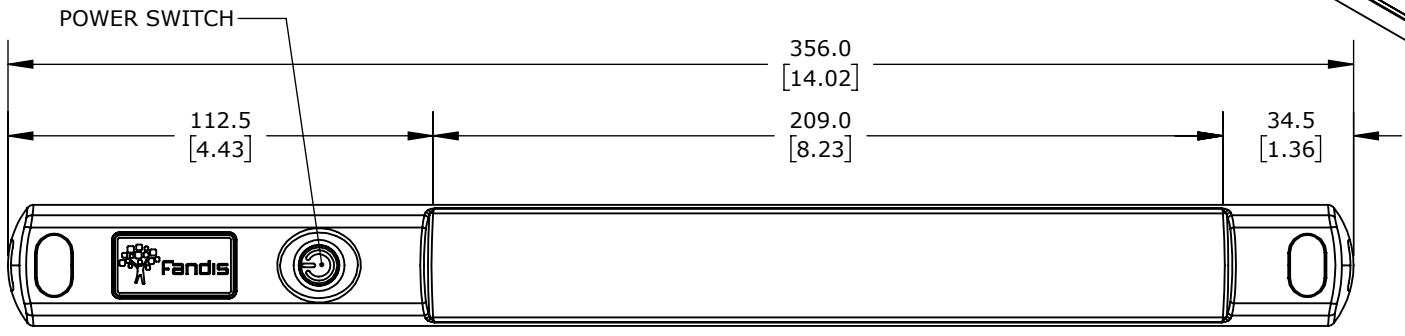

FANDIS LUMEIS ENCLOSURE LIGHTS

FLL-A2306USTB

AutomationDirect.com
1-800-633-0405

3rd ANGLE	NOT TO SCALE	PART DIMENSIONS MAY DIFFER SLIGHTLY DUE TO MANUFACTURER'S VARIANCES	METRIC UNITS USED FOR PART DESIGN	UNLESS OTHERWISE SPECIFIED UNITS ARE: mm [inch]	MODEL REV. --	DRAWING DATE 12/18/2025	SHEET 1 OF 1
-----------	--------------	---	-----------------------------------	--	---------------	-------------------------	--------------