

DETAIL A  
SCALE 1 : 4

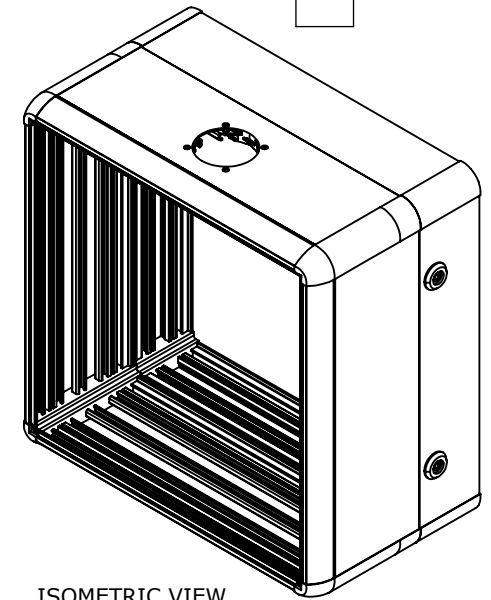

ISOMETRIC VIEW

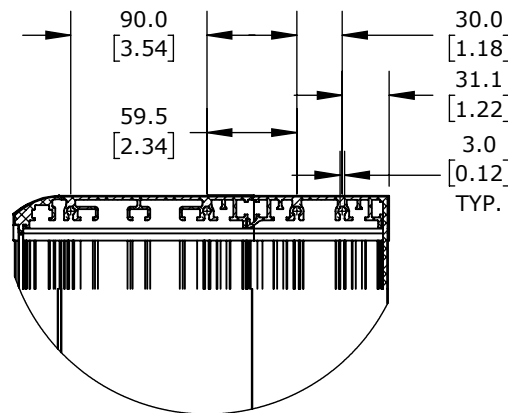
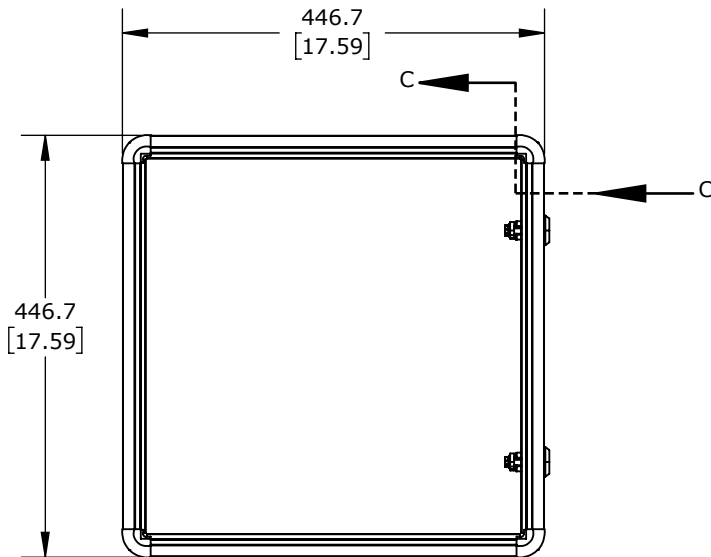

SECTION B  
SCALE 1 : 5

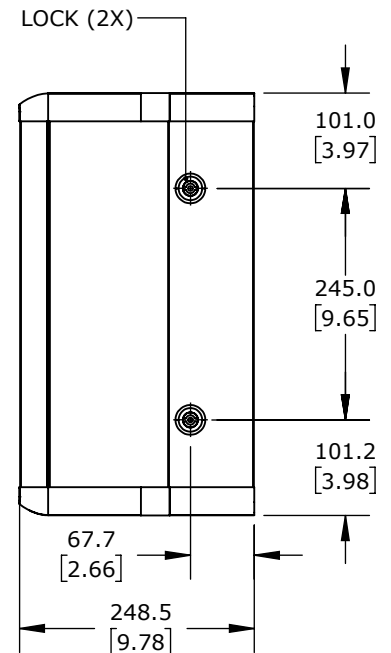

TEKNOKOL ECO SERIES HMI ENCLOSURE, 16 X 16 X 9IN (HXWXD), SUSPENSION MOUNT, ALUMINUM, NATURAL FINISH, SCREW COVER.

ECO1590.0009

AutomationDirect.com  
1-800-633-0405



3rd  
ANGLE

NOT TO  
SCALE

PART DIMENSIONS MAY DIFFER SLIGHTLY  
DUE TO MANUFACTURER'S VARIANCES

METRIC UNITS USED  
FOR PART DESIGN

UNLESS OTHERWISE  
SPECIFIED UNITS ARE:

mm  
[inch]

LATEST VERSION  
8/28/2024

SHEET 1 OF 1