

DETAIL A
SCALE 1 : 4

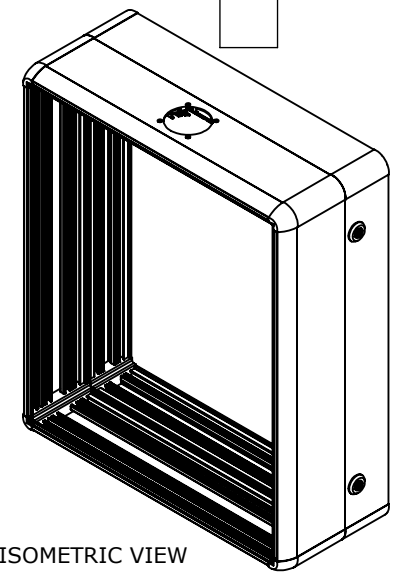

ISOMETRIC VIEW

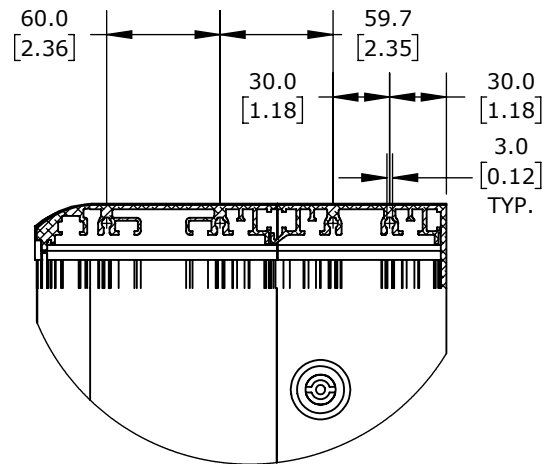
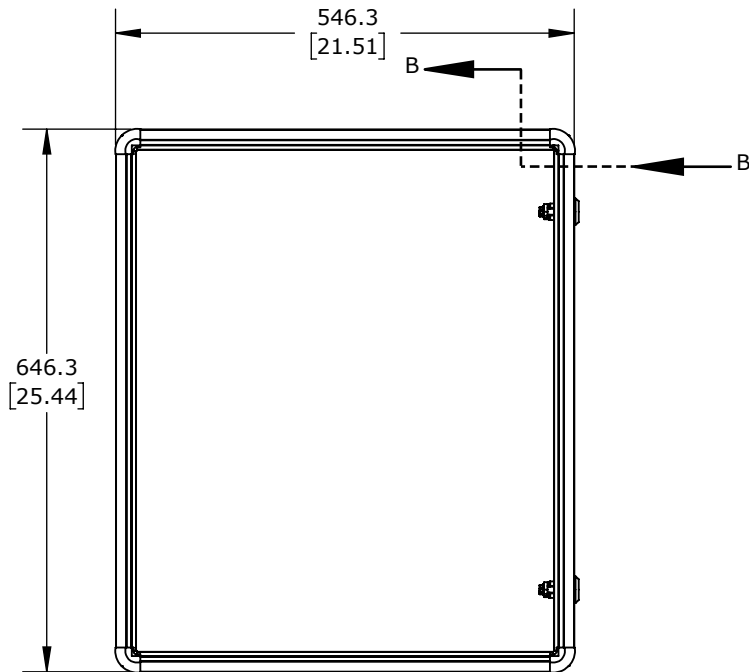

SECTION B
SCALE 1 : 4

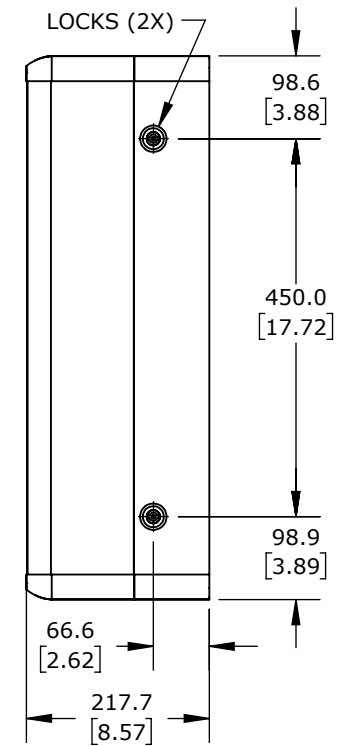

TEKNOKOL ECO SERIES HMI ENCLOSURE, 20 X 24 X 8IN (HXWXD), SUSPENSION MOUNT, ALUMINUM, NATURAL FINISH, SCREW COVER.

ECO1290.0015

AutomationDirect.com
1-800-633-0405



3rd
ANGLE

NOT TO
SCALE

PART DIMENSIONS MAY DIFFER SLIGHTLY
DUE TO MANUFACTURER'S VARIANCES

METRIC UNITS USED
FOR PART DESIGN

UNLESS OTHERWISE
SPECIFIED UNITS ARE:

mm
[inch]

LATEST VERSION
8/28/2024

SHEET 1 OF 1