

PANEL CUTOUT DETAIL

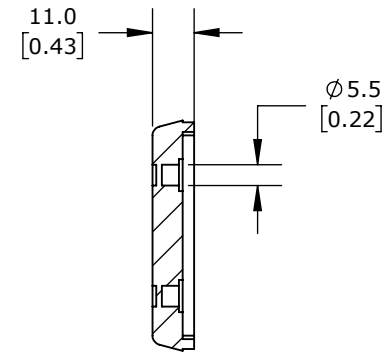
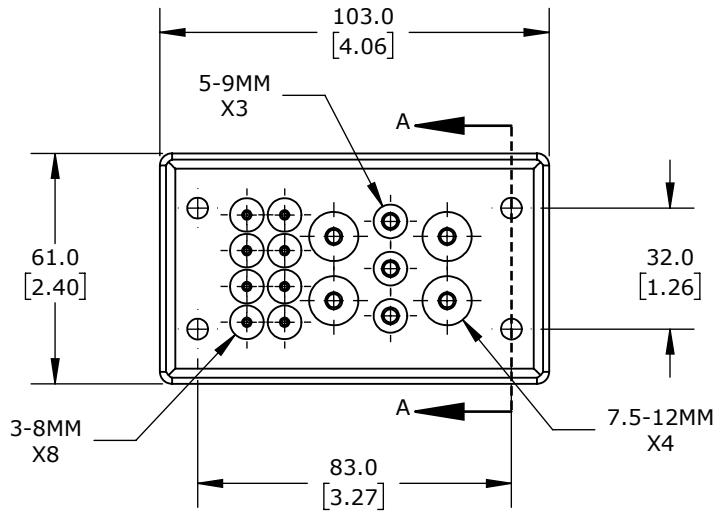
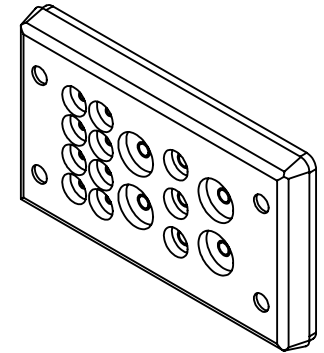

SECTION A-A

POLYPROPYLENE FRAME, TPS GROMMET BLOCK, 10-PIN FRAME, BLACK, (8) 3-8MM, (3) 5-9MM AND (4) 7.5-12MM OPENING(S), UL TYPE 4X AND 12, IP65 IP66 IP67. PACKAGE OF 5.

MURRPLASTIK KDP/Z CABLE ENTRY SYSTEM FRAME

567403

AutomationDirect.com
1-800-633-0405



3rd
ANGLE

NOT TO
SCALE

PART DIMENSIONS MAY DIFFER SLIGHTLY
DUE TO MANUFACTURER'S VARIANCES

METRIC UNITS USED
FOR PART DESIGN

UNLESS OTHERWISE
SPECIFIED UNITS ARE:

mm
[inch]

LATEST VERSION
10/14/2024

SHEET 1 OF 1