

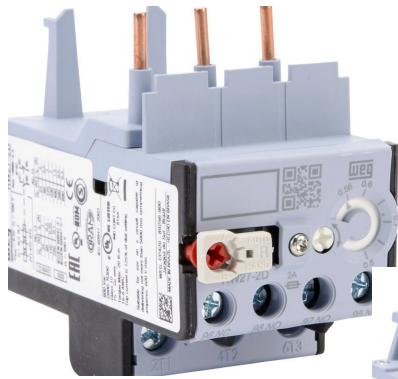

Thermal Overload Relays

RW Series – Bi-Metallic



RW27-2D3-D008

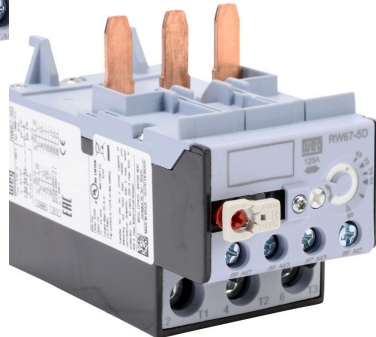

RW67-5D3-U080

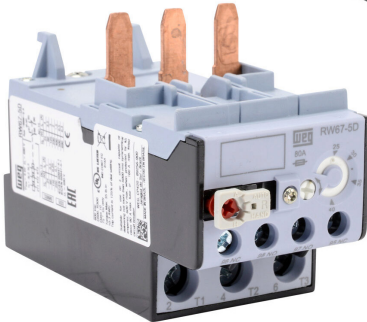

RW67-5D3-U040

Overview

An extended operational service life is one of the main features you'll find in RW overload relays. WEG's RW Thermal Overload Relays are designed for use with, and as perfect complement to, WEG contactors. RW overload relays can be mounted directly under WEG contactors, assuring electrical and mechanical operation as an open across-the-line starter. Accessories are also available for separate mounting.

Features

- 3-pole version available
- Direct mounting to WEG contactors with no accessory required (accessories also available for separate mounting)
- Phase-loss and current unbalance sensitivity protection
- Class 10 trip characteristics
- Selectable RESET button (auto or manual)
- Isolated 1NO and 1NC auxiliary contacts



UL File No. E189202

RW Series Contactor Catalog Number Sequence

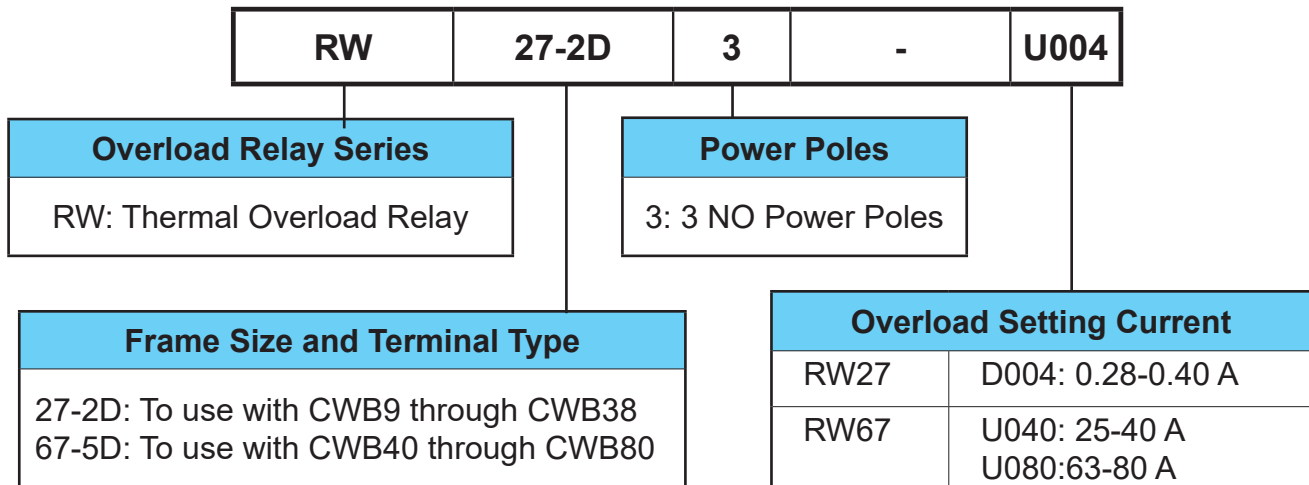

Table intended as reference only and not to create part numbers.
For complete list of overload setting ranges, refer to selection guide tables.



Thermal Overload Relays RW Series – Bi-Metallic

Multifunction Reset/Test Button

The thermal overload relay has a multifunction RESET/TEST button that can be set in four different positions:

- A - Automatic RESET only
- AUTO - Automatic RESET / TEST
- HAND - Manual RESET / TEST
- H - Manual RESET only

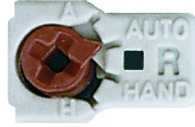

In HAND and AUTO positions, when the RESET button is pressed, both NO (97-98) and NC (95-96) contacts change states.

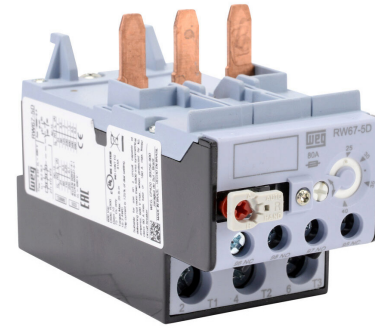

RW67-5D3-U040

Operation

In the H (manual RESET only) or A (automatic RESET only) position, the test function is blocked. However, in the HAND (manual RESET/TEST) or AUTO (automatic RESET/TEST) positions it is possible to simulate the test and the trip functions by pressing the RESET button.

When set in the H or HAND position, the RESET button must be pressed manually to reset the overload relay after a tripping event. On the other hand, when set in A or AUTO position, the overload relay will reset automatically after a tripping event.

The H, HAND, AUTO or A function settings are selected by rotating without pressing the red button and placing it in the desired position.

When changing from HAND to AUTO, the RESET button must be slightly pressed while the red button is rotated.

Function	H	HAND	AUTO	A
Relay Reset	Manual1	Manual1	Automatic	Automatic
Auxiliary Contact Trip Test 95-96 (NC)	Function is disabled	Test is allowed	Test is allowed	Function is disabled
Auxiliary Contact Trip Test 97-98 (NO)	Function is disabled	Test is allowed	Test is allowed	Function is disabled

Note: A recovery time of a few minutes is necessary before resetting the thermal overload relay.

Recovery Time

The RW thermal overload relays have thermal memory. After tripping due to an overload, the relay requires a certain period of time (the "recovery time") for the bimetal strips to cool down. The relay can only be reset once it has cooled down. The recovery time depends on the characteristic tripping curves and the level of the tripping current. After tripping due to overload, the recovery time allows the load to cool down.

Dial FLA Setting

The trip current is set via a continuously adjustable dial designed with the motor's full load current (FLA) in mind.

Temperature compensation

Because RW thermal overload relays include a fourth bimetallic strip in addition to the three that are directly heated by the motor current, ambient temperature variations in the range of -4°F to +140°F [-20°C to +60°C] are no obstacle for accurate protection of your motors even in the toughest conditions.

Phase Failure Sensitivity

WEG overload relays include phase failure sensitivity protection as a standard. This feature ensures fast tripping in case of phase-loss, protecting your motor and avoiding expensive repairs/corrective maintenance.



Thermal Overload Relays RW Series – Bi-Metallic

Three-Pole Thermal Overload Relay Class 10 For Use With CWB Contactors

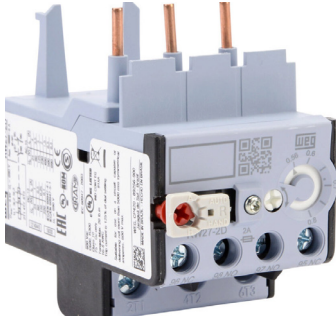

RW27-2D3-D008

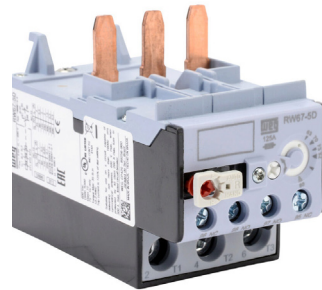

RW67-5D3-U080

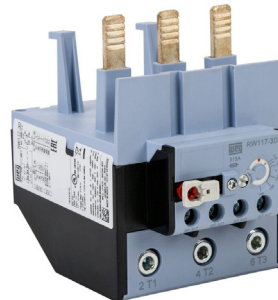

RW117-3D3-U140

Features

- Adjustable trip current
- Phase-loss sensitivity
- Trip Class 10
- Built-in auxiliary contacts: 1 NO and 1 NC
- Ambient temperature compensation (-4°F to +140°F [-20°C to +60°C])
- Multi-function button: Hand/ Auto/Reset

RW Series Bi-Metallic Thermal Overload Relays Selection Guide

Part Number	Price	Matching Contactor	Setting Range (A)		Max. Fuse (A)	Drawing
			Minimum	Maximum		
RW27-2D3-D008	\$28.00	CWB9 CWB12 CWB18 CWB25 CWB32 CWB38	0.56	0.80	15	PDF
RW27-2D3-D012	\$28.00		0.8	1.20	15	PDF
RW27-2D3-D018	\$28.00		1.2	1.80	15	PDF
RW27-2D3-D028	\$28.00		1.8	2.80	15	PDF
RW27-2D3-U004	\$28.00		2.8	4	15	PDF
RW27-2D3-D063	\$28.00		4	6.30	25	PDF
RW27-2D3-U008	\$28.00		5.6	8	30	PDF
RW27-2D3-U010	\$28.00		7	10	40	PDF
RW27-2D3-D125	\$28.00		8	12.5	50	PDF
RW27-2D3-U017	\$28.00		11	17	60	PDF
RW27-2D3-U023	\$28.00		15	23	90	PDF
RW27-2D3-U032	\$28.00		22	32	90	PDF
RW27-2D3-U040	\$31.50		32	40	90	PDF
RW67-5D3-U040	\$54.00	CWB40 CWB50 CWB65 CWB80	25	40	90	PDF
RW67-5D3-U050	\$54.00		32	50	125	PDF
RW67-5D3-U057	\$54.00		40	57	150	PDF
RW67-5D3-U063	\$54.00		50	63	150	PDF
RW67-5D3-U070	\$63.00		57	70	175	PDF
RW67-5D3-U080	\$63.00		63	80	200	PDF
RW117-3D3-U080	\$106.00	CWB95-CWB125	63	80	200	PDF
RW117-3D3-U097	\$120.00		75	97	225	PDF
RW117-3D3-U112	\$125.00		90	112	250	PDF
RW117-3D3-U140	\$143.00		110	140	315	PDF



Thermal Overload Relays RW Series – Bi-Metallic

Separate Mounting Bracket



BF27-2D

RW Series Bi-Metallic Thermal Overload Relays Mounting Bracket Selection Guide				
<i>Part Number</i>	<i>Price</i>	<i>Description</i>	<i>Mounting on Overload Relays (2- or 3-Pole)</i>	<i>Dimensional Drawing</i>
<u>BF27-2D</u>	\$8.50	Enables overload relay to be directly mounted to a back panel via screws or DIN rail	RW27-2D	PDF
<u>BF67-5D</u>	\$15.00	Enables overload relay to be directly mounted to a back panel via screws or DIN rail	RW67-5D	PDF



Thermal Overload Relays

RW Series – Bi-Metallic

RW Series Bi-Metallic Thermal Overload Relays Specifications – General Data and Main Contacts

			RW27	RW67
Standards			IEC 60947 / UL 508	
Setting Current	A		0.28-40	25-80
Tripping Class			10	
Temperature Compensation			Continuous	
Rated Insulation Voltage U_i (Pollution Degree 3)	IEC 60947	V	690	
	UL/CSA	V	600	
Rated Impulse Withstand Voltage U_{imp}			kV 6	
Rated Operational Frequency			Hz 0-400	
Degree of protection Protection against direct contact from the front when actuated by a perpendicular test finger (IEC 536)			IP20 Finger and back-of-hand proof	
Ambient Temperature	Operating temperature		-25°C to +60°C [-13°F to +140°F]	
	Storage temperature		-40°C to +70°C [-40°F to +158°F]	
Environmental Testing (IEC 60 068-2-3, IEC 60 068-2-30)			Damp heat. Constant	
Current Heat Loss				
Lower Value of Setting Range	W		0.9	1.5
Higher Value of Setting Range	W		1.7	4.7

RW Series Bi-Metallic Thermal Overload Relays Specifications – Auxiliary Contacts

			RW27	RW67
Standards			IEC 60947-4-1, UL 508	
Rated Insulation Voltage U_i (Pollution Degree 3)	IEC	V	690	
	UL/CSA	V	600	
Rated Operational Voltage U_e	IEC	V	690	
	UL/CSA	V	600	
Rated Thermal Current I_{th} ($\theta \leq 55^\circ\text{C}$)			A 6	
Rated Operational Current I_e				
AC-14 / AC-15 (IEC 60947-5-1)	24V	A	4	
	60V	A	3.5	
	125V	A	3	
	230V	A	2	
	400V	A	1.5	
	500V	A	0.5	
	690V	A	0.3	
UL, CSA			C600	
DC-13 / DC-14 (IEC 60947-5-1)	24V	A	1	
	60V	A	0.5	
	110V	A	0.25	
	220V	A	0.1	
UL, CSA			R300	
Short-Circuit Protection With Fuse (RK5)			A 6	
Minimum Voltage / Admissible Current (IEC 60947-5-4)			17V / 5ma	



Thermal Overload Relays

RW Series – Bi-Metallic

RW Series Bi-Metallic Thermal Overload Relays Specifications Terminal Capacity and Tightening Torque – Main Contacts

			RW27	RW67
Current Setting	A		0.28-40	25-80
Cable Size (75°C [167°F]) / Cu Cable				
Flexible Cable	1 cable	mm²	1.5-10	6.0-35
	2 cables	mm²	1.5-10	–
Cable With Terminal or Rigid Cable	1 cable	mm²	1.5-6	6.0-35
	2 cables	mm²	1.5-6	–
Busbar		mm²	–	–
Tightening Torque		N•m [lb•ft]	2.3 [1.69]	4.0 [2.95]
UL Cable Size (75°C [167°F]) / Cu Cable		AWG	16 to 8	10 to 3
Tightening Torque (UL)		N•m [lb•in]	2.26 [20]	3.95 [35]

RW Series Bi-Metallic Thermal Overload Relays Specifications Terminal Capacity and Tightening Torque – Auxiliary Contacts

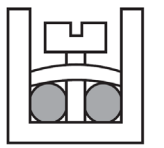
			RW27	RW67
Type of Screws			M3.5x10 Philips	M3.5x10 Philips
Cable Size (75°C [167°F]) / Cu Cable				
Cable With or Without Terminal	mm²		2 x 1-2.5	2 x 1-2.5
Wire	AWG		16-12	16-12
Tightening Torque	N•m [lb•in]		1.5 [13]	1.5 [13]



Thermal Overload Relays RW Series – Bi-Metallic

RW Series Bi-Metallic Thermal Overload Relays Specifications – General Technical Data

			<i>RW27</i>
Standards			IEC 60947-1, UL 508
Rated insulation voltage U_i (Pollution Degree 3)	<i>IEC/EN 60947-4-1</i>	V	690
	<i>UL, CSA</i>	V	600
Rated impulse withstand voltage U_{imp} (IEC 60947-1)		kV	6
Rated operational frequency		Hz	25-400
Use with direct current?			Yes
Maximum operation per hour		ops/h	15
Protection degree (IEC 60529)	Main contacts		IP10
	Auxiliary contacts		IP20
	Frontal		IP20
Mounting			Direct on the contactor
Resistance to Impact (IEC 60068-2-27 - 1/2 sinusoid)		g/ms	10/11
Ambient Temperature	Transport and storage		-50°C to +80°C [-58°F to +176°F]
	Operating		-20°C to +70°C [-4°F to +158°F]
	Temperature compensation		-20°C to +60°C [-4°F to +140°F]
Altitude		m [ft]	2000 [6562]

RW Series Bi-Metallic Thermal Overload Relays Specifications – Main Contacts

			<i>RW27</i>
Rated Operational Voltage U_e	<i>IEC 60947-4-1</i>	V	690
	<i>UL, CSA</i>	V	600
Setting Current / Max Fuse (Class RK5)	A		0.28-0.4 / 2
			0.43-0.63 / 2
			0.56-0.8 / 2
			0.8-1.2 / 4
			1.2-1.8 / 6
			1.8-2.8 / 6
			2.8-4 / 10
			4-6.3 / 16
			5.6- 8 / 20
			7-10 / 25
			8-12.5 / 25
			10-15 / 35
			11-17 / 40
			15-23 / 50
	22-32 / 63		
	32-40 / 90		
Average Power Dissipation Per Pole		W	≤3



Thermal Overload Relays RW Series – Bi-Metallic

RW Tripping Characteristics

These tripping characteristics show the tripping of RW in relation to the current. They show the mean values of the tolerance ranges at an ambient temperature of 68°F (20°C), starting from cold stats. The tripping time of the overload releases at operational temperature is reduced to approximately 25% of the values shown. Under normal operational conditions, all Three-Phases of the RWs should be loaded.

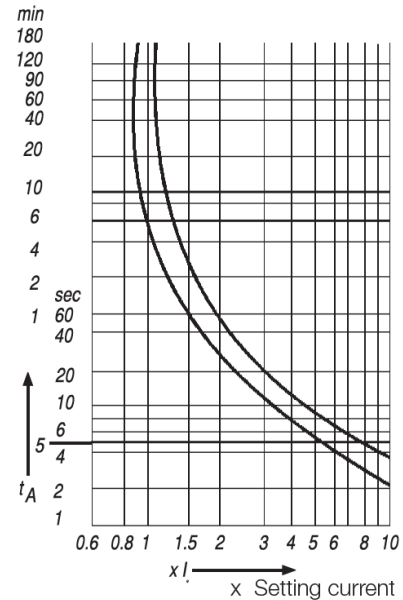

Altitude and Temperature Derating

Derating of an RW overload relay is based on two possible factors.

Ambient temperature:

Temperature compensation considers a factor according to which the rated current must be reduced when ambient temperature is higher than 60°C [140°F].

Altitude:

Altitude compensation involves both rated current and voltage.

- Current compensation considers a factor according to the rated current must be reduced.
- For voltage, altitude limits the higher operating voltage the overload relay can be used.

Derating Calculation

The derating of the permissible operating current for installation altitudes above 2000m (6667 ft) and ambient temperatures over 60°C (140°F) is calculated according to the following formula:

Total derating = Derating altitude x Derating ambient temperature

Temperature Compensation (F [C])	Current Correction Factor
149 [65]	0.94
158 [70]	0.87
167 [75]	0.81
176 [80]	0.73

Derating Example

Here is an example of how derating is calculated.

- Altitude: 3000m (10,000 ft)
- K1 = 0.96
- Ambient temperature: 70°C (158°F)
- K2 = 0.87

Total current derating = 0.96 x 0.87 = 0.84 x Ie

In this case, the maximum rated voltage that can be connected to the RW overload relay is 550V.

In order to select the proper overload relay, choose a device with a current range that accommodates the following:

$$\text{Overload Setting Point} = \text{FLA motor} / (\text{K1} \times \text{K2})$$

As in the example above, K1 x K2 = 0.84

For a motor with FLA = 20A:

$$\text{Overload Setting Point} = 20 / 0.84 = 23.8\text{A}$$

Altitude	Voltage Correction (Ue)
Up to 2000m (6667ft)	690
Up to 3000m (10,000 ft)	550
Up to 4000m (13,333 ft)	480
Up to 5000m (16,667ft)	420

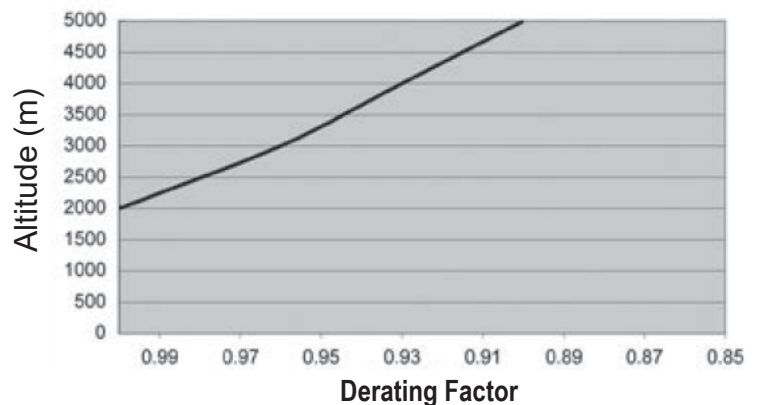



Thermal Overload Relays

RW Series – Bi-Metallic



RW117 Technical Specifications		
Compliance With Standards		IEC 60947-1 and UL 508
Frequency Limits		25 - 400 Hz
Use in Direct Current		Yes
Maximum Frequency of Operation Cycles		15 operations per hour
Protection Rating (IEC 60529)	Main terminals	IP10
	Auxiliary contacts	IP10
	Other regions	IP20
Mounting		Directly to contactors or with screws and DIN rail 35mm (EN 50022) using an accessory
Resistance to Mechanical Shocks (IEC 60068-2-27, 1/2 sine wave)		10 / 11 g/ms
Ambient Temperature	Transport and storage	-50°C to 80°C [-58°F to 176°F]
	Operation	-20°C to 70°C [-4°F to 158°F]
Maximum operation altitude without modification in the rated values	Temperature compensation	-20°C to 60°C [-4°F to 140°F]
Maximum Operation Altitude Without Modification of the Rated Values		2000m

RW117 Main Contacts Specifications		
Rated Insulation Voltage U_i Pollution Degree 3	IEC 60947-4-1	690V
	UL, CSA	600V
Rated Impulse Withstand Voltage U_{imp}		6kV
Current Settings / Maximum Fuse (gL/gG)		63-80 / 200 A
		75 - 97 / 225 A
		90 - 112 / 250 A
		110 - 140 / 315 A
Average Power Dissipation Per Pole		≤5.5 W

RW117 Auxiliary Circuit Technical Specifications		
Compliance With Standards		IEC 60947-1 and UL 508
Rated Insulation Voltage U_i Pollution Degree 3	IEC	690V
	UL, CSA	600V
Rated Operational Voltage U_i	IEC	690V
	UL, CSA	600V
Conventional Thermal Current I_{th} ($\theta \leq 55^\circ\text{C}$)		6A
Rated Operational Current		
AC-14/AC-15 (IEC 60947-5-1)	24V	4A
	60V	3.5 A
	125V	3A
	230V	2A
	400V	1.5 A
	500V	0.5A
	690V	0.3A
UL, CSA		C600
DC-13/DC-14 (IEC 60947-5-1)	24V	1A
	60V	0.5A
	110V	0.25A
	220V	0.1A
UL, CSA		R300
Short Circuit Protection With Fuse (gI/gG)		6A
Minimum Voltage/Permissible Current (IEC 60947-5-4)		17V / 5mA

Thermal Overload Relays

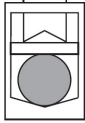
RW Series – Bi-Metallic

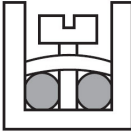
RW117 Terminal Capacity and Tightening Torque (Power Circuit) Specifications		
Mounting System Screw Type		M10 Allen
Conductor Connection at the Bottom		
Flexible Conductor		25 - 36 mm ²
Conductor With Terminal/Ferrules		25 - 36 mm ²
Flexible Conductor		25 - 36 mm ²
Wire / Cable AWG		8 - 1/0 AWG
Torque		6 N•m
Mounting System Screw Type		
Screw Type		M12 Hexagonal
Cable With Terminal/Ferrules		-
Busbars (mm) - Maximum Size		2 x (60x10 mm ²)
Torque		26 N•m
RW117 Terminal Capacity and Tightening Torque (Auxiliary Contacts) Specifications		
Mounting System Screw Type		M3.5x10 Philips
Conductor Cross-Section		
Wire / Conductor With or Without Terminal/Ferrules		2 x (1-2.5 mm ²)
Torque		1.5 N•m



Thermal Overload Relays RW Series – Bi-Metallic

Separate Mounting Bracket



BF27-2D

RW Series Bi-Metallic Thermal Overload Relays Mounting Bracket Selection Guide				
<i>Part Number</i>	<i>Price</i>	<i>Description</i>	<i>Mounting on Overload Relays (2- or 3-Pole)</i>	<i>Drawing</i>
<u>BF27-2D</u>	\$8.50	Enables overload relay to be directly mounted to a back panel via screws or DIN rail	RW27-2D	PDF
<u>BF67-5D</u>	\$15.00	Enables overload relay to be directly mounted to a back panel via screws or DIN rail	RW67-5D	PDF
<u>BF117-3D</u>	\$17.00	35mm DIN rail/panel mount adapter, for use with RW117-3D series thermal overload relays.	RW117-3D	PDF



RW-E Series Solid State Overload Relays

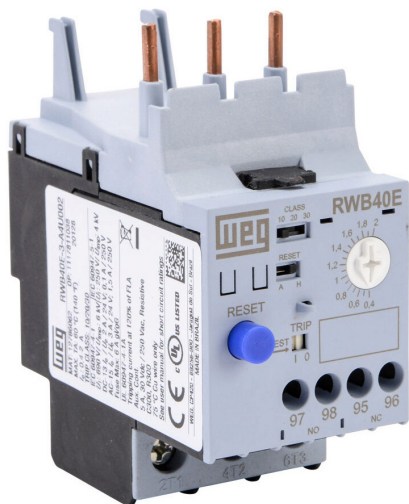

RWB40E-3-A4U002

Overview

RW-E Series Solid State Overload relays are developed with cutting-edge technology to meet the most demanding standards worldwide. With their wide current/AMP setting range, RW-E Series OL Relays can be used for protection of electric motors of different power ratings. The benefit is versatility and flexibility for manufacturers due to the possibility of standardization of control panels. This Solid State Overload Relay can be directly mounted on WEG Contactors (CWB line) providing very reliable and flexible motor starter units. The RW-E Series counts on two independent and highly reliable built in auxiliary contacts that assure the motor is switched off when a failure occurs.

Features

- 3-pole solid state overload relays with adjustable trip class: 10, 20 and 30
- Self-powered
- Wide 5:1 adjustment range
- Thermal memory
- Phase-loss protection (less than 5s)
- Phase unbalance protection (>40% between phases)
- Temperature compensated (-20°C [-4°F] up to +60°C [+140°F])
- Manual or automatic reset modes
- Direct mounting on CWB9-38 contactor
- Separate mounting is possible with accessories
- 1NO + 1NC built in auxiliary contacts



UL File No. E189202

RW-E Solid-State Overload Relay Catalog Number Sequence

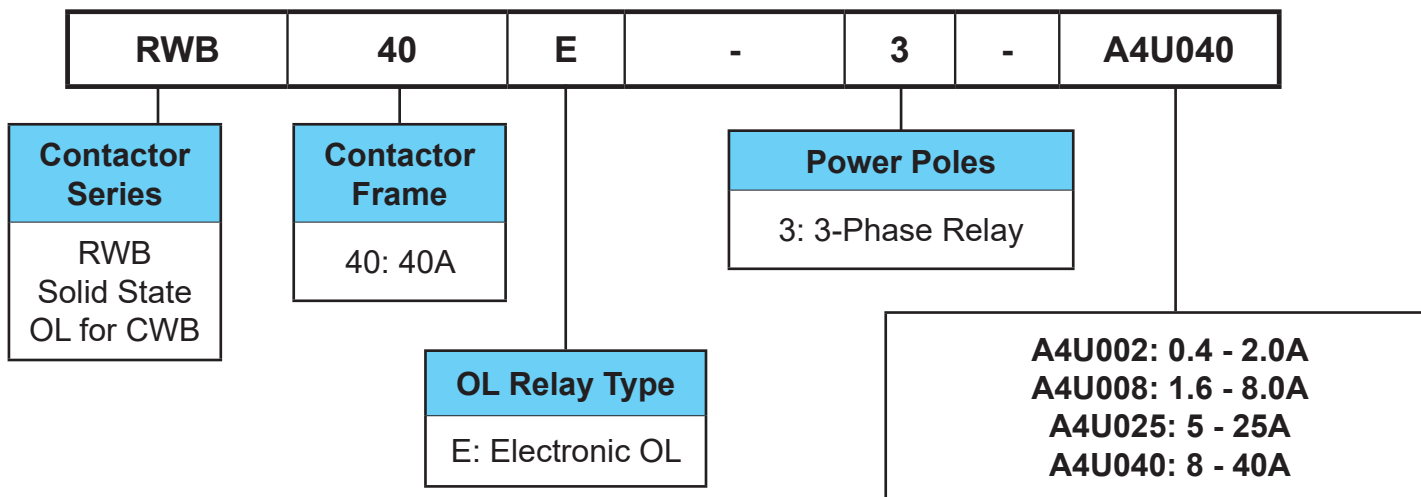

Table intended as reference only and not to create part numbers.

Weg RW-E Series Solid State Overload Relays

Suitable for a Wide Range of Applications

RW-E Series solid-state overload relays are suitable for protecting motors in a wide range of industrial applications including those where long starting time is required. Motors used in low, medium or heavy duty applications can be properly protected just by selecting the proper trip class (10, 20 or 30 according to IEC 60947-4-1) on the DIP-switches.

Additionally, the microprocessor electronic circuits of RW Series solid-state overload relays are temperature compensated according to IEC 60947-4-1, which means that throughout the temperature range of -20°C [-4°F] up to +60°C [140°F], the tripping point is not affected and performs consistently without undesirable tripping.

The RW-E Series also features thermal memory which assures that the heating and cooling effects of motors are modeled and that proper protection is guaranteed even after downtime periods.

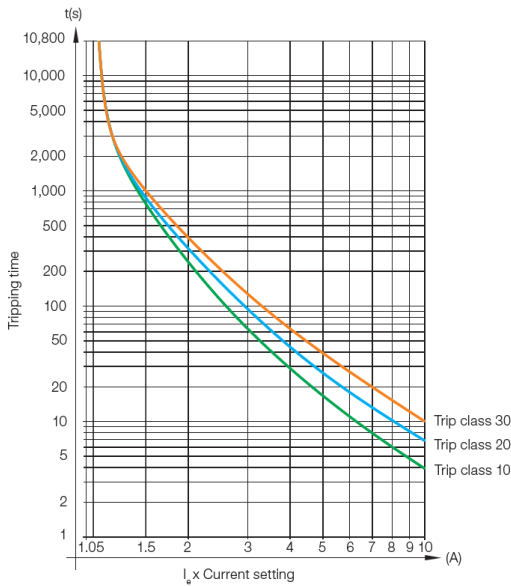

Trip Class	Multiples of Current Setting			
	1.05 x I _r	1.2 x I _r	1.5 x I _r	7.2 x I _r
10	-	T _p <2h	T _p <4min	4<T _p ≤10s
20	-	T _p <2h	T _p <8min	6<T _p ≤20s
30	-	T _p <2h	T _p <12min	9<T _p ≤30s

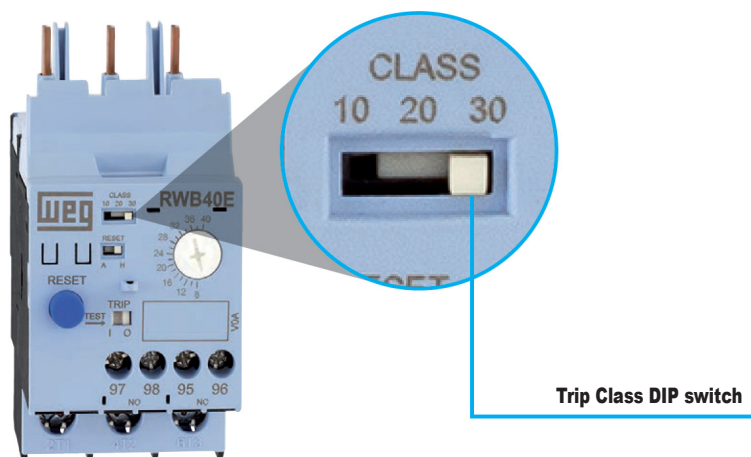

Trip Class DIP switch



RW-E Series Solid State Overload Relays

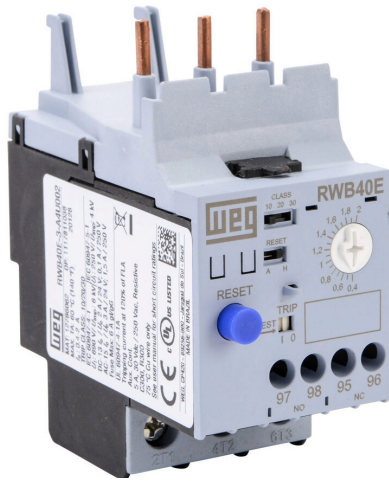

RWB40E-3-A4U002

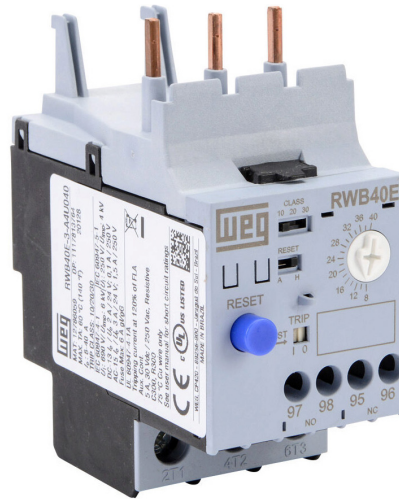

RWB40E-3-A4U040

RW-E Series Solid-State Overload Relays Selection Guide							
Part Number	Price	For Direct Mounting on Contactors	Current Range A	Max. Fuse (gL/gG) A	Diagram	Weight (kg [lb])	Dimensional Drawing
RWB40E-3-A4U002	\$53.00	CWB9 through CWB38	0.4-2	16		0.25 [0.55]	PDF
RWB40E-3-A4U008	\$53.00		1.6-8	32			PDF
RWB40E-3-A4U025	\$53.00		5-25	63			PDF
RWB40E-3-A4U040	\$83.00		8-40	125			PDF

Note: Not to be used in single-phase applications.



RWB-E Series Solid State Overload Relays

Mounting Kit



BF27-2D

RW-E Series Solid-State Overload Relays Mounting Kit Selection Guide

<i>Part Number</i>	<i>Price</i>	<i>Description</i>	<i>For Use With</i>	<i>Weight (kg [lb])</i>	<i>Dimensional Drawing</i>
<u>BF27-2D</u>	\$8.50	Enables the overload relay to be mounted directly to a panel via screws or 35mm DIN rail	RWB40E	0.05 [0.11]	PDF



RW-E Series Solid State Overload Relays

RW-E Series Series Solid State Overload Relays Specifications – General Data			
			RWB40E
Standards			IEC 60947-4-1, IEC 60947-5-1, IEC 60947-1, UL 60947-1, UL 60947-4-1A and UL 508
Rated Insulation Voltage U_i (Pollution Degree 3)	IEC 60947-4-1	V	690
	UL/CSA	V	600
Rated impulse withstand voltage U_{imp}		kV	6
Rated Operational Frequency (Sinusoidal Networks)		Hz	50/60
Suitable for use	Three-phase loads		Yes
	Single-phase/two-phase loads		No
	DC current loads		No
Trip class (IEC 60947-4-1)			10, 20 or 30, selectable
Additional featured protections	Phase-loss		Yes, <5s
	Phase unbalance		Yes, >40%
Reset	Manual/minimum downtime for reset		Yes / instantaneous
	Automatic/minimum downtime for reset		Yes / ≥90s
Maximum Operations Per Hour			30
Protection degree (IEC 60529)	Main contacts		IP10
	Auxiliary contacts		IP20
Mounting			Direct mounting on contactor or directly on the panel via screws or 35mm DIN rail when using the mounting kit accessory (BF27-2D)
Mechanical shock resistance 1/2 sinusoid			15g / 11ms
Vibration resistance (IEC 60068-2-6)			6g / 30-300 Hz
Ambient Temperature	Transport and storage		-50°C to +80°C [-58°F to +176°F]
	Operating		-20°C to +60°C [-4°F to +140°F]
	Temperature compensation		-20°C to +60°C [-4°F to +140°F]
Altitude			2000m [6562ft]

RW Series Series Solid State Overload Relays Specifications – Main Contacts			
			RWB40E
Rated Operational Voltage U_e (Pollution Degree 3)	IEC 60947-4-1	V	690
	UL/CSA	V	600
Current Setting / Max Fuse (RK5)		A	0.4-2 / 16 1.6-8 / 32 5-25 / 63 8-40 / 125
Setting Current / Average Power Dissipation Per Pole		W	0.4-2 / 0.07 1.6-8 / 0.06 5-25 / 0.38 8-40 / 1.5



RW-E Series Solid State Overload Relays

RW-E Series Series Solid State Overload Relays Specifications – Auxiliary Contacts

			<i>RWB40E</i>
Rated Insulation Voltage U_i (Pollution Degree 3)	IEC 60947-4-1	V	250
	UL/CSA	V	600
Rated Impulse Withstand Voltage U_{imp} (IEC 60947-1)		kV	4
Rated Operational Voltage U_e	IEC 60947-4-1	V	250
	UL/CSA	V	600
Rated Thermal Current $I_{th} \leq 60^\circ\text{C}$		A	5
Rated Operational Current I_e			
AC-14/AC-15 (IEC 60947-5-1)	24V	A	3
	120V	A	3
	250V	A	1.5
DC-13 (IEC 60947-5-1)	24V	A	2
	60V	A	0.4
	110V	A	0.22
	125V	A	0.22
	250V	A	0.1
NEMA Control Circuit Ratings	UL, CSA		C300 / R300
Short-Circuit Protection With Fuse		A	6
Minimum Voltage / Admissible Current (IEC 60947-5-4)			12V / 10mA

RW-E Series Series Solid State Overload Relays Specifications Terminal Capacity and Tightening Torque – Main Contacts

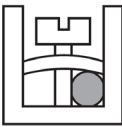
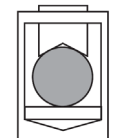
			<i>RWB40E</i>
Type of Screw			M3.5 Flat / Phillips #2
Cable Size			
Flexible Cable	mm ²		–
Cable With Terminal / Rigid Cable	mm ²		–
AWG Wire			–
Tightening Torque	N•m [lb•ft]		–
Wire			
Flexible Cable	mm ²		1-10
Cable With Terminal / Rigid Cable	mm ²		1-10
Wire	AWG		16-8
Tightening Torque	N•m [lb•ft]		1.7

RW-E Series Series Solid State Overload Relays Specifications Terminal Capacity and Tightening Torque – Auxiliary Contacts

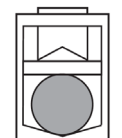
			<i>RWB40E</i>
Type of Screw			Flat / Phillips #1
Cable Size			
Cable With or Without Terminal	mm ²		1 x 1-2.5
Wire	AWG		16-12
Tightening Torque	N•m [lb•ft]		0.8 [0.59]

WEG RW-E Series Solid State Overload Relays

Technical Data

Motor Protection – Alternating Current

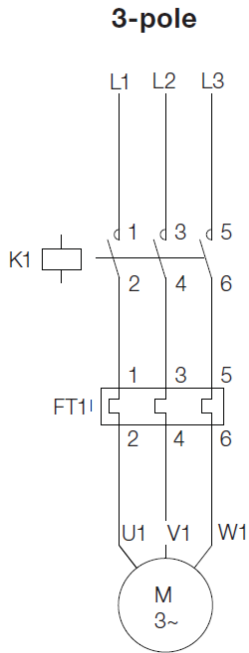

Typical Connection – Contactor + Overload Relay

Direct On Line Starter (1 Direction of Rotation)

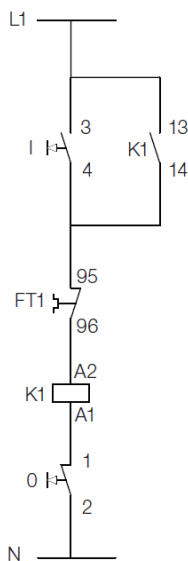

Direct On Line Starter (2 Directions of Rotation)

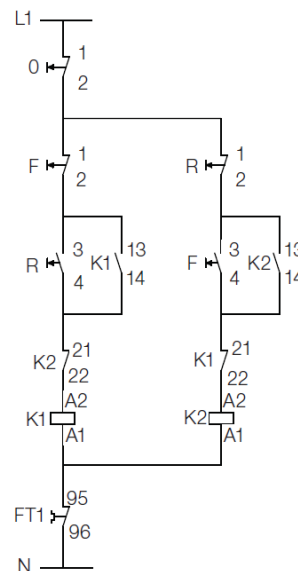



RW-E Series Solid State Overload Relays

RWB40E Mounting Position

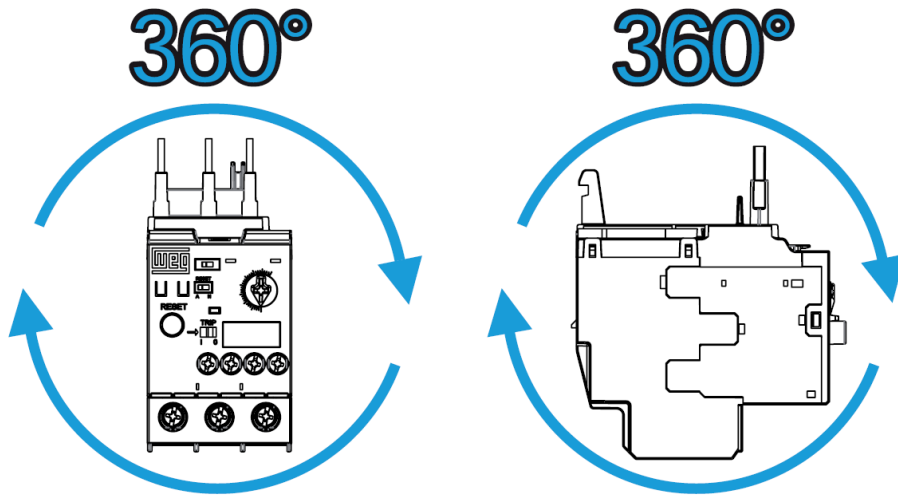

Mounting Position