



Multi-Channel Electronic Circuit Breakers



Features

- Space saving ECB's with two, four, and eight channels
- Models range from 0.5-10A nominal current, adjustable for each channel via sealable selector switch
- One illuminated, three color button per channel simplifies switching (on/off), resetting, and on-site diagnostics
- Time-delayed switching of channels
- NEC Class 2 3.8 A fixed models available
- Remote input resets tripped channels or switches on/off any number of channels via pulse sequence.
- Easy to use Push-In CAGE CLAMP® terminals.

Applications

- 24VDC Circuit Protection
- PLC Input Power
- PLC I/O points
- Sensors
- Motor Controlled Circuits
- Control Instrumentation
- Relays
- Actuators
- Valves

Overview

The electronic circuit breaker distributes and monitors the load current over several circuits. They reliably recognize overloads and short circuits on an output. The circuit breakers' electronics permit brief current peaks and switch longer overloads off. The rated current for each output can be individually set with a current selector switch, which is accessible from the front. The outputs are time-delay and load-dependant activated to avoid overload current. If the rated current is exceeded for a set time, the output will be switched off automatically and can be switched on after a waiting time (thermal relaxation) using the pushbutton or the remote signal-input S1. The pushbutton can also be used to switch the output manually. The state of each output is also indicated with a multi-colored LED. Upon overload, the remaining circuits are separated from the defective current path without reverse feed, thanks to Active Current Limiting. A drop in voltage will not hinder the reliability of the respective circuit.

Multiple Channel Electronic Circuit Breaker Selection Chart

Part Number	Price	Channel Units	Weight g [lbs]	Nominal Output Current (Per Channel)	Mounting	Output Voltage	Active Current Limitation	Connection	Wiring	Drawing Link
787-1662-004-1000	\$262.00	2	200 [0.44]	3.8 A	35mm DIN rail	24VDC	Yes, NEC Class 2	Push-in CAGE CLAMP®	Diagram 2	PDF
787-1662-006-1000	\$236.00	2	170 [0.37]	0.5-6 A			Yes		Diagram 1	PDF
787-1662-106-000	\$189.00	2	170 [0.37]	1-6 A I			No		Diagram 3	PDF
787-1662	\$189.00	2	200 [0.44]	2-10 A			No		Diagram 4	PDF
787-1664-004-1000	\$368.00	4	205 [0.45]	3.8 A			Yes, NEC Class 2		Diagram 6	PDF
787-1664-006-1000	\$327.00	4	170 [0.37]	0.5-6 A			Yes		Diagram 5	PDF
787-1664-106-000	\$243.00	4	210 [0.46]	1-6 A			No		Diagram 7	PDF
787-1664	\$233.00	4	170 [0.37]	2-10 A			No		Diagram 8	PDF
787-1668-006-1000	\$554.00	8	440 [0.97]	0.5-6 A			Yes		Diagram 9	PDF
787-1668-106-000	\$390.00	8	490 [1.08]	1-6 A			No		Diagram 10	PDF
787-1668	\$390.00	8	440 [0.97]	2-10 A			No		Diagram 11	PDF



Multi-Channel Electronic Circuit Breakers

Multiple Channel ECB Specifications	
Nominal Input Voltage	24VDC
Input Voltage Range	18 – 30VDC
Total Number of Channels	See Selection Chart
Nominal Output Voltage	24VDC
Output Voltage Range	18 – 30VDC
Voltage Drop	See Product Insert
Nominal Output Current	See Selection Chart
Trip Time	16ms to 5s [Load-dependent]
Switch-On Capacity	See Product Insert
Switch-On Behavior	Time-delayed channel switching [Load-dependent, min. 50ms / max. 5s]
Active Current Limitation	See Selection Chart
Signaling	2,4, or 8 x Status LED [green/yellow/red] 1 x Control input 2 x active signal output [Ui max. 4 mA]
Operation Status Indicator	See LED Operation Table Below
Remote Input	18 – 30VDC signal, for 500ms switches on/off and resets the tripped channels
Fuse Protection	15A [Internal Fuse]
Isolation Voltage	DC 0.5 kV
Protection Type	IP20 [per EN 60529]
Reverse Voltage Protection	No
Transient Suppression	Suppressor diode [33V]
Series/Parallel Operation of Single Channels	Not Permitted
Tightening Torque	N/A
Weight	See Selection Chart
Connectors	Push-In CAGE CLAMP®, Input [+] 20-8 AWG, Input [-], Output, Signaling 28-12 AWG
Agency Approvals	EN 60950; EN 61000-6-2; EN 61000-6-3; UL 508; UL 2367; DNV GL; CE; RoHS
Surrounding Air Temperature (Operation)	-25 to 70°C [-13 to 158°F]
Surrounding Air Temperature (Storage)	-25 to 85°C [-13 to 185°F]
Relative Humidity	5 to 96% [no condensation permissible]
Derating	No derating Models **787-1664 & 787-1668 [greater than or equal to 50°C [122°F]; see instruction manual]
Pollution Degree	2

LED Operation		
State/Description	Output	LED
Initialization	Off	Off
Output on, function OK	On	Green
Output Current > rated current	On	Green flashing
Output was switched off manually or through signal input S1	Off	Red
Output was switched off automatically (over current), thermal relaxation active	Off	Red flashing
Output was switched off automatically (over current), thermal relaxation finished	Off	Orange flashing
Output malfunction (internal fuse blown)	Off	Red flashing fast



Multi-Channel Electronic Circuit Breakers

Wiring Diagrams

Diagram 1

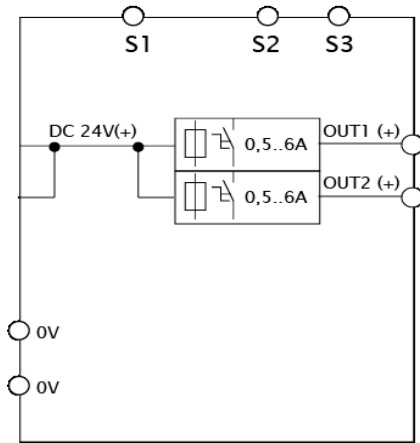

Diagram 2

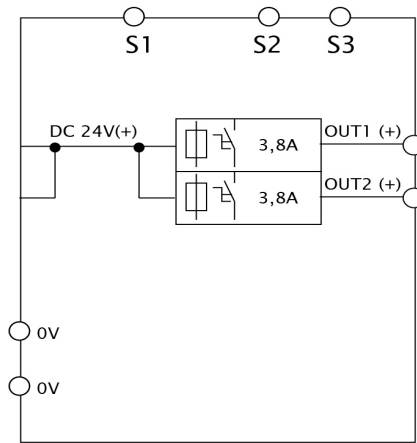

Diagram 3

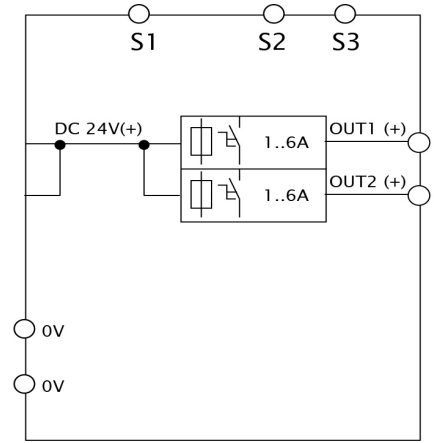

Diagram 4

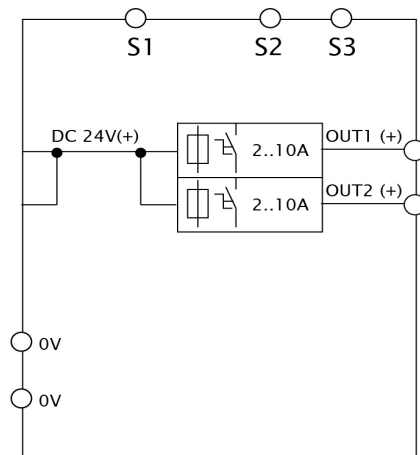

Diagram 5

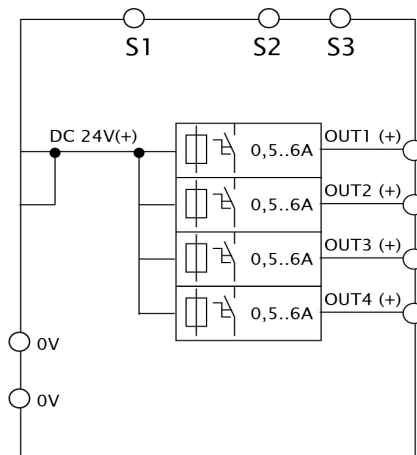
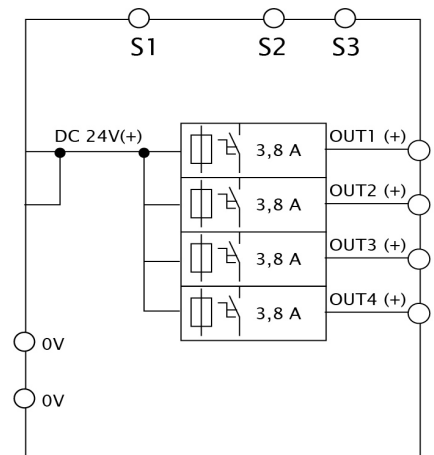

Diagram 6





Multi-Channel Electronic Circuit Breakers

Wiring Diagrams

Diagram 7

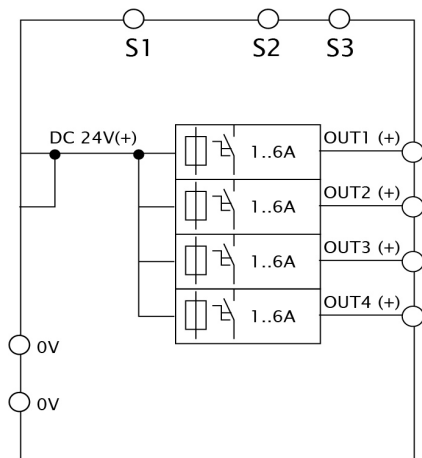

Diagram 8

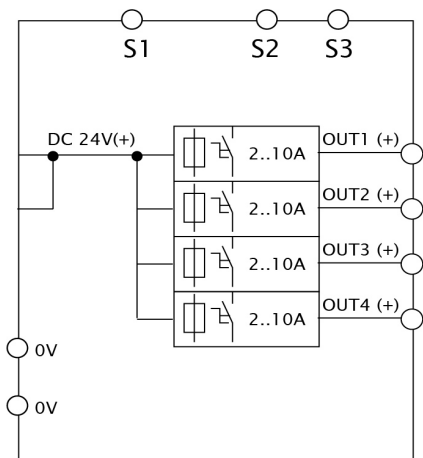

Diagram 9

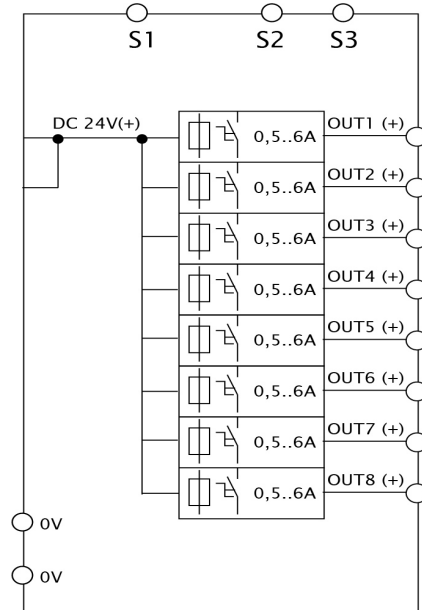

Diagram 10

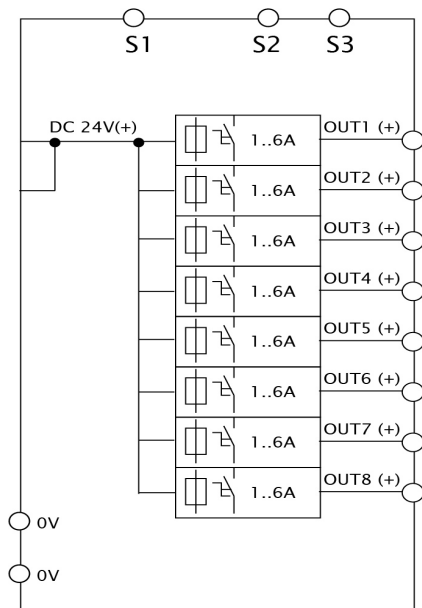

Diagram 11

