

# IDEM SCR73 Series Single/Dual Channel Viper Safety Relays



SCR73-280005

The Viper Safety Relays series from IDEM are designed with enhanced LED diagnostics and simplified wiring. Applications include guard door monitoring, emergency stop devices and sensors. The SCR73 series' internal logic uses force guided relays to achieve cross monitoring. This ensures that a single fault does not lead to the loss of the safety function and that all faults are detected at or before the next safety demand.

*Note: Not for use with safety light curtains*

## Features

- Single or dual channel operation
- Monitored manual or automatic start
- Up to 7 safety output contacts and 3 auxiliary output contacts
- Easy diagnostics of status via 6 LEDs
- 45mm DIN rail mounting



### Safety Data per EN 13849-1

<b>Category</b>	4
<b>Performance level</b>	Ple
<b>MTTF<sub>d</sub></b>	71a (High)
<b>DC<sub>avg</sub></b>	99% (High)

### Safety Data per IEC/EN 62061, IEC/EN 61508

<b>Sil CL</b>	SIL CL 3
<b>Sil</b>	SIL3
<b>HFT</b>	1 (Dual channel)
<b>DC<sub>avg</sub></b>	99% (High)
<b>SFF</b>	90-99%
<b>PFH<sub>d</sub> (t-20a)</b>	7.20E <sup>-05</sup>

## SCR73 Series Single/Dual Channel Safety Relay

Part Number	Price	Type	Voltage	Outputs	Connection
<b>SCR73-280005</b>	\$399.00	Single/Dual channel operation	24V AC/DC	7 NO / 3 NC	Fixed screw terminals
<b>SCR73-280005-P</b>	\$481.00				Pluggable terminals

## SCR73 Series Specifications

General Specifications	
<b>Temperature</b>	-20° to +55°C [-4° to +131°F]
<b>Altitude</b>	< 2,000 meters
<b>Vibration Resistance</b>	Tested to IEC 60068-2-6
<b>Degree Of Protection</b>	IP20
<b>Housing</b>	UL 94V-0 Thermoplastic
<b>Weight</b>	300g (10.5 oz)
<b>Agency Approvals and Standard</b>	cULus file E258676, CE, TUV
<b>Terminal Designation per EN 50 005</b>	1 x 4 mm <sup>2</sup> stranded ferruled (isolated) or 2 x 1.5 mm <sup>2</sup> stranded ferruled (isolated) or 2 x 2.5 mm <sup>2</sup> solid
<b>Wire Fixing</b>	M3.5 terminals with self-lifting wire protection or cage clamp terminals
Input Specifications	
<b>Nominal Voltage</b>	24V AC/DC
<b>Voltage Range</b>	85-110%
<b>Maximum Consumption</b>	5W (24VDC)
<b>Nominal Frequency</b>	50Hz-60Hz
<b>Control Voltage</b>	24VDC (S11)
<b>Control Current</b>	100mA (S11)
<b>Short Circuit Protection</b>	Internal PTC (Positive Temperature Coefficient resistor)
<b>Over Voltage Protection</b>	Internal VDR (Voltage Dependent resistor)
Output Specifications	
<b>Electrical Contact Life</b>	6A / 250VAC 100,000 cycles, 1A / 250VAC 1,000,000 cycles
<b>Mechanical Life</b>	10 x 10 <sup>6</sup>
<b>Contact Type</b>	7 NC positively driven and 3 NO auxiliary contacts
<b>Operate Delay</b>	100ms
<b>Release Delay</b>	25ms
<b>Nominal Output Voltage</b>	250VAC
<b>Thermal Current (I<sub>th</sub>)</b>	Max. 6A
<b>Short Circuit Strength</b>	Minimum Contact Fuses - 4A slow blow, 6A fast blow
<b>Switching Capacity</b>	AC - 250V, 1500V, 6A, Ohmic 230V, 4A for AC-15; DC - 24V, 30W, 1.25 A, Ohmic
<b>Switching Frequency</b>	Max. 360 switching cycles/hr

# IDEM SCR73 Series Single/Dual Channel Viper Safety Relays

## LED Diagnostics

*When safety relay in operation*

Power	Power applied to device
Reset	Reset circuit is closed
CH1	External switch input 1 closed
CH2	External switch input 2 closed
K1	Internal relay safety output contacts closed
K2	Internal relay safety output contacts closed

## Dimensions

mm [in]

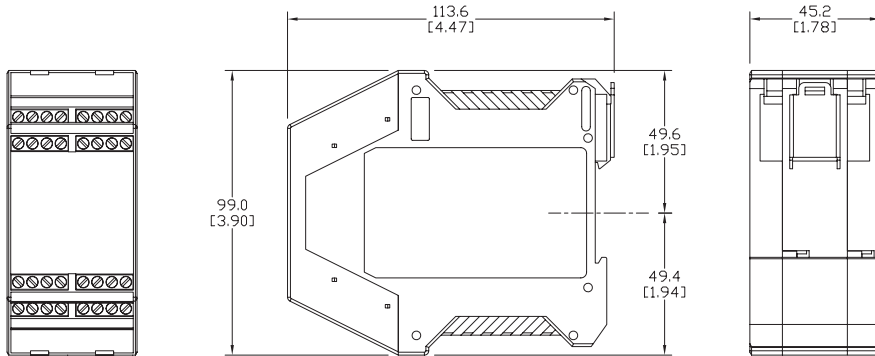

13	23	33	81	43	53	63	73
A1	S11	S21	S22	91	92	101	102

**SCR-73-i**

- POWER
- RESET
- CH1
- CH2
- K1
- K2

S12	S13	S10	A2				
14	24	34	82	44	54	64	74

## Applications

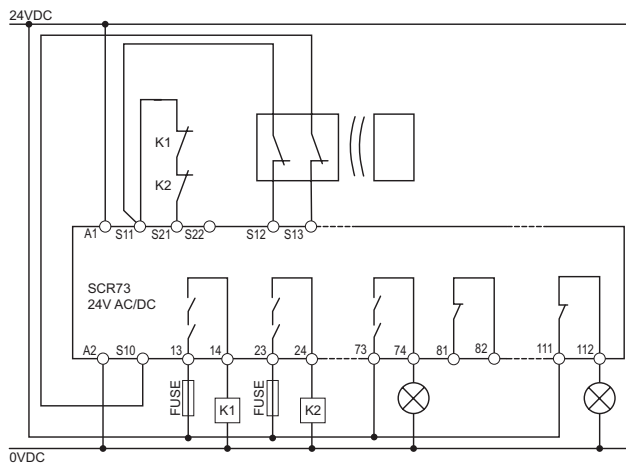

**Automatic restart mode (dual channel) non contact**

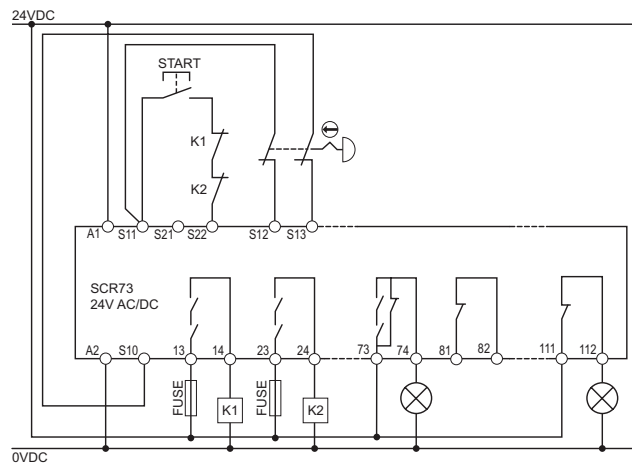

**Manual restart mode (dual channel) E-Stop**

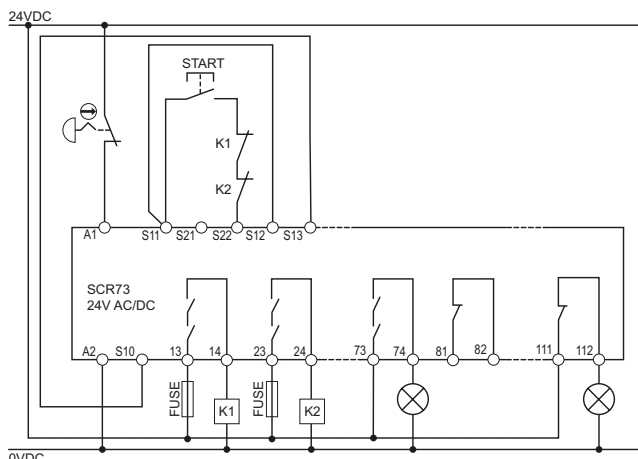

**Manual restart mode (single channel) E-stop**

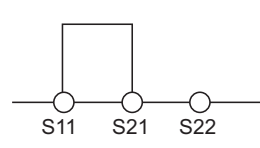

**Auto Reset**

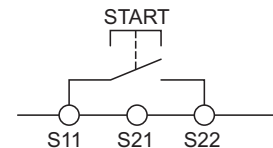

**Manual Reset**

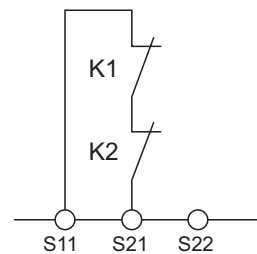

**Contactor Auto Feedback**

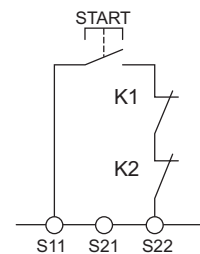

**Contactor Manual Feedback**

*Note: A power supply unit with electrical isolation from the mains supply must be connected. External fusing of each safety output contact is necessary, a 4A slow-blow or 6A (quick action) must be provided. The maximum cabling and connecting resistance of control lines must not be exceeded 300 Ohms.*

# Safety Products



*Warning: Safety products sold by AutomationDirect are Safety components only. The purchaser/installer is solely responsible for the application of these components and ensuring all necessary steps have been taken to assure each application and use meets all performance and applicable safety requirements and/or local, national and/or international safety codes as required by the application. AutomationDirect cannot certify that our products, used solely or in conjunction with other AutomationDirect or other vendors' products, will assure safety for any application. Any person using or applying any products sold by AutomationDirect is responsible for learning the safety requirements for their individual application and applying them, and therefore assumes all risks, and accepts full and complete responsibility, for the selection and suitability of the product for their respective application.*

*AutomationDirect does not provide design or consulting services, and cannot advise whether any specific application or use of our products would ensure compliance with the safety requirements for any application.*