

IDEM SCR73 Series Single/Dual Channel Viper Safety Relays



SCR73-280005

The Viper Safety Relays series from IDEM are designed with enhanced LED diagnostics and simplified wiring. Applications include guard door monitoring, emergency stop devices and sensors. The SCR73 series' internal logic uses force guided relays to achieve cross monitoring. This ensures that a single fault does not lead to the loss of the safety function and that all faults are detected at or before the next safety demand.

Note: Not for use with safety light curtains

Features

- Single or dual channel operation
- Monitored manual or automatic start
- Up to 7 safety output contacts and 3 auxiliary output contacts
- Easy diagnostics of status via 6 LEDs
- 45mm DIN rail mounting



Safety Data per EN 13849-1

| | |
|--------------------------|------------|
| Category | 4 |
| Performance level | Ple |
| MTTF_d | 71a (High) |
| DC_{avg} | 99% (High) |

Safety Data per IEC/EN 62061, IEC/EN 61508

| | |
|--------------------------------|----------------------|
| Sil CL | SIL CL 3 |
| Sil | SIL3 |
| HFT | 1 (Dual channel) |
| DC_{avg} | 99% (High) |
| SFF | 90-99% |
| PFH_d (t-20a) | 7.20E ⁻⁰⁵ |

SCR73 Series Single/Dual Channel Safety Relay

| Part Number | Price | Type | Voltage | Outputs | Connection |
|-----------------------|----------|-------------------------------|-----------|-------------|-----------------------|
| SCR73-280005 | \$399.00 | Single/Dual channel operation | 24V AC/DC | 7 NO / 3 NC | Fixed screw terminals |
| SCR73-280005-P | \$481.00 | | | | Pluggable terminals |

SCR73 Series Specifications

| General Specifications | |
|---|---|
| Temperature | -20° to +55°C [-4° to +131°F] |
| Altitude | < 2,000 meters |
| Vibration Resistance | Tested to IEC 60068-2-6 |
| Degree Of Protection | IP20 |
| Housing | UL 94V-0 Thermoplastic |
| Weight | 300g (10.5 oz) |
| Agency Approvals and Standard | cULus file E258676, CE, TUV |
| Terminal Designation per EN 50 005 | 1 x 4 mm ² stranded ferruled (isolated) or 2 x 1.5 mm ² stranded ferruled (isolated) or 2 x 2.5 mm ² solid |
| Wire Fixing | M3.5 terminals with self-lifting wire protection or cage clamp terminals |
| Input Specifications | |
| Nominal Voltage | 24V AC/DC |
| Voltage Range | 85-110% |
| Maximum Consumption | 5W (24VDC) |
| Nominal Frequency | 50Hz-60Hz |
| Control Voltage | 24VDC (S11) |
| Control Current | 100mA (S11) |
| Short Circuit Protection | Internal PTC (Positive Temperature Coefficient resistor) |
| Over Voltage Protection | Internal VDR (Voltage Dependent resistor) |
| Output Specifications | |
| Electrical Contact Life | 6A / 250VAC 100,000 cycles, 1A / 250VAC 1,000,000 cycles |
| Mechanical Life | 10 x 10 ⁶ |
| Contact Type | 7 NC positively driven and 3 NO auxiliary contacts |
| Operate Delay | 100ms |
| Release Delay | 25ms |
| Nominal Output Voltage | 250VAC |
| Thermal Current (I_{th}) | Max. 6A |
| Short Circuit Strength | Minimum Contact Fuses - 4A slow blow, 6A fast blow |
| Switching Capacity | AC - 250V, 1500V, 6A, Ohmic 230V, 4A for AC-15; DC - 24V, 30W, 1.25 A, Ohmic |
| Switching Frequency | Max. 360 switching cycles/hr |

IDEM SCR73 Series Single/Dual Channel Viper Safety Relays

LED Diagnostics

When safety relay in operation

| | |
|-------|--|
| Power | Power applied to device |
| Reset | Reset circuit is closed |
| CH1 | External switch input 1 closed |
| CH2 | External switch input 2 closed |
| K1 | Internal relay safety output contacts closed |
| K2 | Internal relay safety output contacts closed |

Dimensions

mm [in]

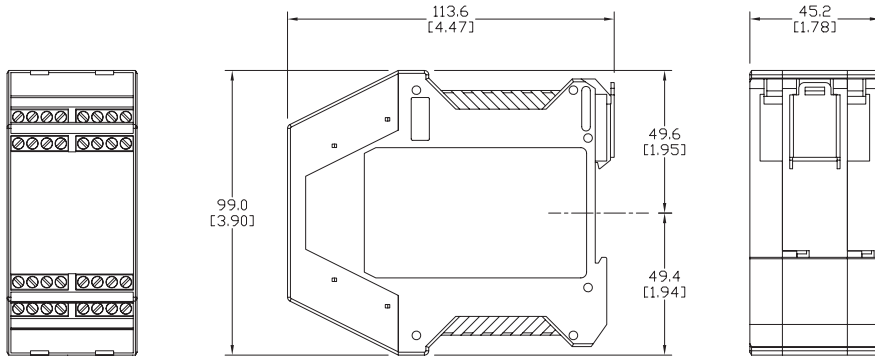

| | | | | | | | |
|----|-----|-----|-----|----|----|-----|-----|
| 13 | 23 | 33 | 81 | 43 | 53 | 63 | 73 |
| A1 | S11 | S21 | S22 | 91 | 92 | 101 | 102 |

SCR-73-i

- POWER
- RESET
- CH1
- CH2
- K1
- K2

| | | | | | | | |
|-----|-----|-----|----|----|----|----|----|
| S12 | S13 | S10 | A2 | | | | |
| 14 | 24 | 34 | 82 | 44 | 54 | 64 | 74 |

Applications

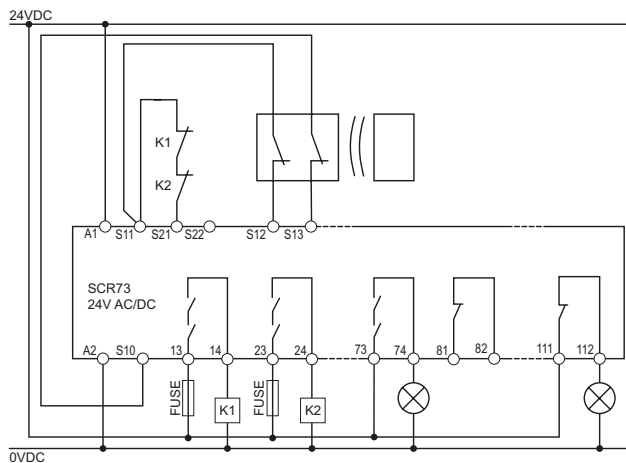

Automatic restart mode (dual channel) non contact

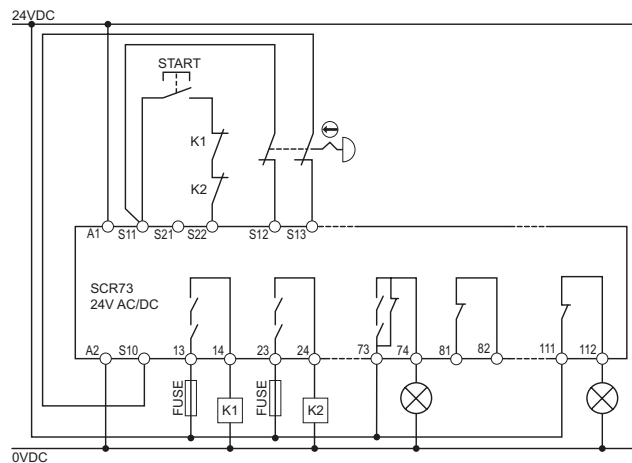

Manual restart mode (dual channel) E-Stop

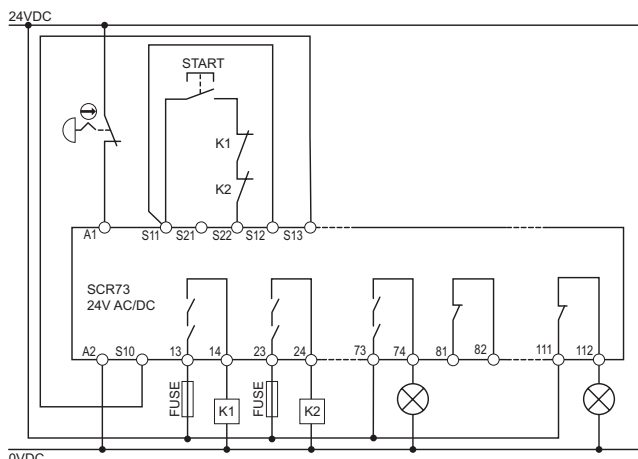

Manual restart mode (single channel) E-stop

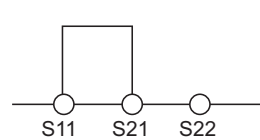

Auto Reset

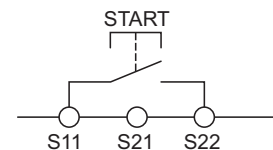

Manual Reset

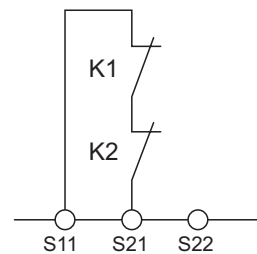

Contactor Auto Feedback

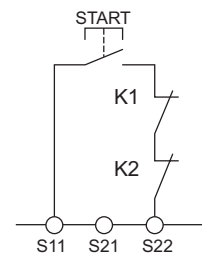

Contactor Manual Feedback

Note: A power supply unit with electrical isolation from the mains supply must be connected. External fusing of each safety output contact is necessary, a 4A slow-blow or 6A (quick action) must be provided. The maximum cabling and connecting resistance of control lines must not be exceeded 300 Ohms.

Safety Products



Warning: Safety products sold by AutomationDirect are Safety components only. The purchaser/installer is solely responsible for the application of these components and ensuring all necessary steps have been taken to assure each application and use meets all performance and applicable safety requirements and/or local, national and/or international safety codes as required by the application. AutomationDirect cannot certify that our products, used solely or in conjunction with other AutomationDirect or other vendors' products, will assure safety for any application. Any person using or applying any products sold by AutomationDirect is responsible for learning the safety requirements for their individual application and applying them, and therefore assumes all risks, and accepts full and complete responsibility, for the selection and suitability of the product for their respective application.

AutomationDirect does not provide design or consulting services, and cannot advise whether any specific application or use of our products would ensure compliance with the safety requirements for any application.