

IDEM SCR73 Series Single/Dual Channel Viper Safety Relays



SCR73-280005

The Viper Safety Relays series from IDEM are designed with enhanced LED diagnostics and simplified wiring. Applications include guard door monitoring, emergency stop devices and sensors. The SCR73 series' internal logic uses force guided relays to achieve cross monitoring. This ensures that a single fault does not lead to the loss of the safety function and that all faults are detected at or before the next safety demand.

Note: Not for use with safety light curtains

Features

- Single or dual channel operation
- Monitored manual or automatic start
- Up to 7 safety output contacts and 3 auxiliary output contacts
- Easy diagnostics of status via 6 LEDs
- 45mm DIN rail mounting



Safety Data per EN 13849-1

Category	4
Performance level	Ple
MTTF_d	71a (High)
DC_{avg}	99% (High)

Safety Data per IEC/EN 62061, IEC/EN 61508

Sil CL	SIL CL 3
Sil	SIL3
HFT	1 (Dual channel)
DC_{avg}	99% (High)
SFF	90-99%
PFH_d (t-20a)	7.20E ⁻⁰⁵

SCR73 Series Single/Dual Channel Safety Relay

Part Number	Price	Type	Voltage	Outputs	Connection
SCR73-280005	\$399.00	Single/Dual channel operation	24V AC/DC	7 NO / 3 NC	Fixed screw terminals
SCR73-280005-P	\$481.00				Pluggable terminals

SCR73 Series Specifications

General Specifications	
Temperature	-20° to +55°C [-4° to +131°F]
Altitude	< 2,000 meters
Vibration Resistance	Tested to IEC 60068-2-6
Degree Of Protection	IP20
Housing	UL 94V-0 Thermoplastic
Weight	300g (10.5 oz)
Agency Approvals and Standard	cULus file E258676, CE, TUV
Terminal Designation per EN 50 005	1 x 4 mm ² stranded ferruled (isolated) or 2 x 1.5 mm ² stranded ferruled (isolated) or 2 x 2.5 mm ² solid
Wire Fixing	M3.5 terminals with self-lifting wire protection or cage clamp terminals
Input Specifications	
Nominal Voltage	24V AC/DC
Voltage Range	85-110%
Maximum Consumption	5W (24VDC)
Nominal Frequency	50Hz-60Hz
Control Voltage	24VDC (S11)
Control Current	100mA (S11)
Short Circuit Protection	Internal PTC (Positive Temperature Coefficient resistor)
Over Voltage Protection	Internal VDR (Voltage Dependent resistor)
Output Specifications	
Electrical Contact Life	6A / 250VAC 100,000 cycles, 1A / 250VAC 1,000,000 cycles
Mechanical Life	10 x 10 ⁶
Contact Type	7 NC positively driven and 3 NO auxiliary contacts
Operate Delay	100ms
Release Delay	25ms
Nominal Output Voltage	250VAC
Thermal Current (I_{th})	Max. 6A
Short Circuit Strength	Minimum Contact Fuses - 4A slow blow, 6A fast blow
Switching Capacity	AC - 250V, 1500V, 6A, Ohmic 230V, 4A for AC-15; DC - 24V, 30W, 1.25 A, Ohmic
Switching Frequency	Max. 360 switching cycles/hr

IDEM SCR73 Series Single/Dual Channel Viper Safety Relays

LED Diagnostics

When safety relay in operation

Power	Power applied to device
Reset	Reset circuit is closed
CH1	External switch input 1 closed
CH2	External switch input 2 closed
K1	Internal relay safety output contacts closed
K2	Internal relay safety output contacts closed

Dimensions

mm [in]

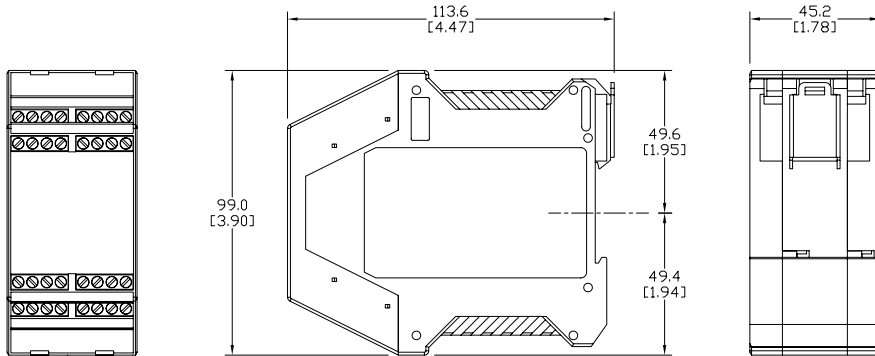

13	23	33	81	43	53	63	73
A1	S11	S21	S22	91	92	101	102

SCR-73-i

- POWER
- RESET
- CH1
- CH2
- K1
- K2

VIPER

S12	S13	S10	A2				
14	24	34	82	44	54	64	74

Applications

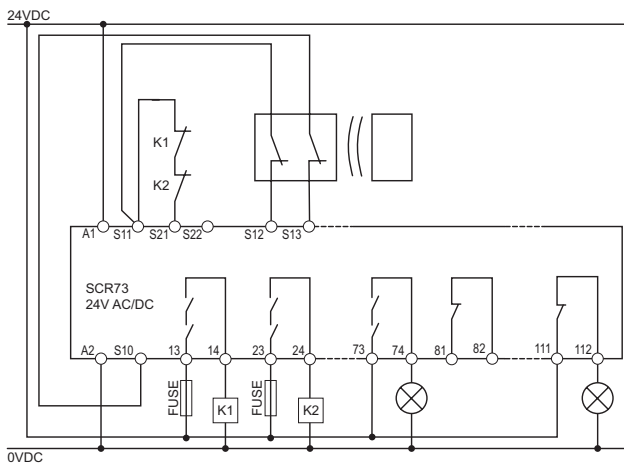

Automatic restart mode (dual channel) non contact

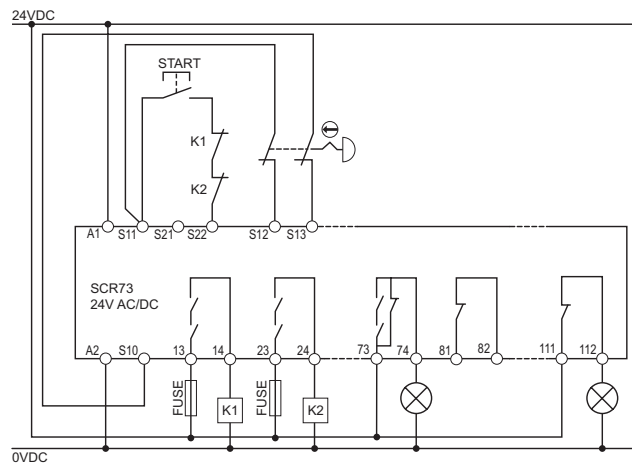

Manual restart mode (dual channel) E-Stop

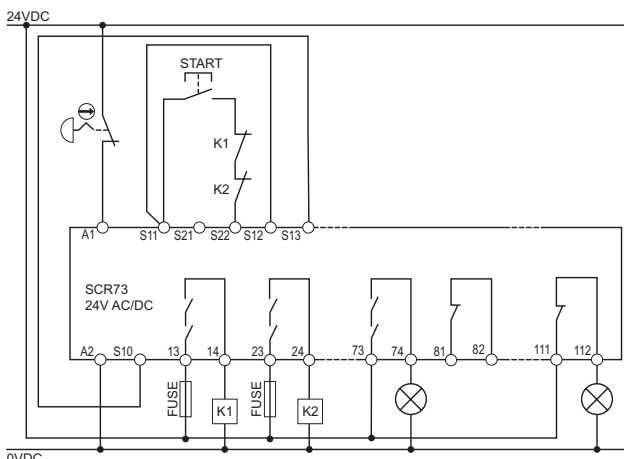

Manual restart mode (single channel) E-stop

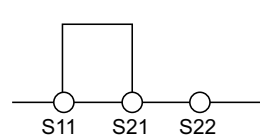

Auto Reset

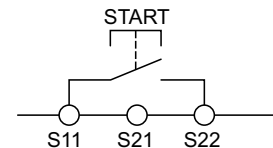

Manual Reset

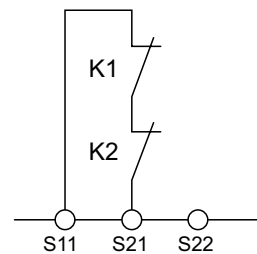

Contactor Auto Feedback

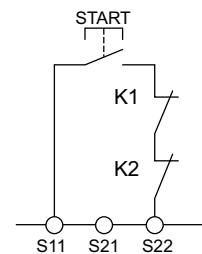

Contactor Manual Feedback

Note: A power supply unit with electrical isolation from the mains supply must be connected. External fusing of each safety output contact is necessary, a 4A slow-blow or 6A (quick action) must be provided. The maximum cabling and connecting resistance of control lines must not be exceeded 300 Ohms.

Safety Products



Warning: Safety products sold by AutomationDirect are Safety components only. The purchaser/installer is solely responsible for the application of these components and ensuring all necessary steps have been taken to assure each application and use meets all performance and applicable safety requirements and/or local, national and/or international safety codes as required by the application. AutomationDirect cannot certify that our products, used solely or in conjunction with other AutomationDirect or other vendors' products, will assure safety for any application. Any person using or applying any products sold by AutomationDirect is responsible for learning the safety requirements for their individual application and applying them, and therefore assumes all risks, and accepts full and complete responsibility, for the selection and suitability of the product for their respective application.

AutomationDirect does not provide design or consulting services, and cannot advise whether any specific application or use of our products would ensure compliance with the safety requirements for any application.