



VFS Series (-1001) Vortex Flow Sensors



Part No. VFSXX-X-1001

Overview

AutomationDirect's ProSense VFS series vortex flow sensors offer a very cost-effective solution optimized for monitoring water and deionized water flow in industrial applications. Vortex flow sensors are a reliable alternative to other flow sensing technologies and are a simple, low cost, and proven method for measuring flow of water-based liquids that is independent of the liquid's pressure or temperature fluctuations. Using the pushbuttons and display, the VFS series can be easily set up to measure both flow rate and temperature. The VFS series is available with 1/2" or 3/4" NPT process connections. The VFS (-1001) series offers two separate outputs that can be used either as a flow or temperature limit switch or to monitor continuous flow rate or temperature. The TFT color display and switch point LEDs are used during configuration and operation to provide clear indication of both flow and temperature measured variables simultaneously.

Features

Optimized for measurement of water and deionized water flow applications

- Cost effective solution for flow switch or continuous flow measurement
- Volumetric flow rate and temperature measurement
- TFT color display with pushbutton setup
- 1/2" or 3/4" NPT rotatable process connections
- Two outputs selectable for switch or frequency signals
- 4-pin M12 quick disconnect electrical connection
- 5-year warranty



Output Function Selections

Output 1: 2 Selection Options

- Switching signal for flow limit value
- Frequency signal for flow

Output 2: 4 Selection Options

- Switching signal for flow limit value
- Switching signal for temperature limit value
- Frequency signal for flow
- Frequency signal for temperature



ProSense VFS Series (-1001) Vortex Flow Sensors			
Model	VFS50-5-1001	VFS50-10-1001	VFS75-26-1001
Price	\$223.00	\$223.00	\$240.00
Application			
Media	Water and deionized water		
Medium Temperature*	14 to 194°F (-10 to 90°C)		
Pressure Rating**	174 psig (12 bar)		
Electrical Data			
Operating Voltage	18 to 30 VDC		
Current Consumption	< 30mA		
Insulation Resistance	100MΩ @ 500VDC		
Protection Class	III		
Reverse Polarity Protection	Yes		
Power-on Delay Time	< 3 seconds		
Outputs			
Number of Digital Outputs	2		
Output Signal	Switch or frequency PNP / NPN Selectable N.O. / N.C. Selectable Max. voltage drop: 2.5 VDC Current rating: 100mA Frequency: 0 to 1000 Hz		
Short-circuit Protection	Yes		
Overload Protection	Yes		
* Water mixed with glycol or with dissolved solids, such as a saline solution, used to lower the freezing point will also increase the viscosity of the solution reducing the flow accuracy. See Flow Monitoring Accuracy in table below.			
** Up to 104°F (40°C)			

pro^{sense} VFS Series (-1001) Vortex Flow Sensors

ProSense VFS Series (-1001) Vortex Flow Sensors			
Model	VFS50-5-1001	VFS50-10-1001	VFS75-26-1001
Flow Rate Monitoring			
Measuring Range*	0.26 to 5.28 GPM (16 to 317 GPH)	0.55 to 10.55 GPM (32 to 634 GPH)	1.3 to 26.4 GPM (80 to 1585 GPH)
Display Range	0 to 6.34 GPM (0 to 380 GPH)	0 to 12.7 GPM (0 to 760 GPH)	0 to 31.7 GPM (0 to 1900 GPH)
Resolution	0.02 GPM (1 GPH)	0.05 GPM (2 GPH)	0.1 GPM (5 GPH)
Set Point, SP	0.32 to 5.28 GPM (10 to 317 GPH)	0.65 to 10.55 GPM (38 to 634 GPH)	1.6 to 26.4 GPM (95 to 1585 GPH)
Reset Point, rP	0.26 to 5.24 GPM (16 to 314 GPH)	0.55 to 10.45 GPM (32 to 628 GPH)	1.3 to 26.2 GPM (80 to 1570 GPH)
Process Value End Point (@ FRP), FEP	1.06 to 5.28 GPM (63 to 317 GPH)	2.1 to 10.55 GPM (126 to 634 GPH)	5.3 to 26.4 GPM (315 to 1585 GPH)
In Steps Of	0.02 GPM (1 GPH)	0.05 GPM (2 GPH)	0.1 GPM (5 GPH)
Frequency at Process Value End Point, FRP	100 to 1,000 Hz		
Temperature Monitoring			
Measuring Range	14 to 194°F		
Display Range	-22 to 230°F		
Resolution	1°F		
Set Point, SP	16 to 194°F		
Reset Point, rP	14 to 192°F		
In Steps Of	1°F		
Process Value Start Point (@ 0Hz), FSP	14 to 158°F		
Process Value End Point (@ FRP), FEP	50 to 194°F		
Frequency at Process Value End Point, FRP	100 to 1,000 Hz		
Accuracy / Deviations			
Flow Monitoring			
Accuracy (In the Measuring Range)**	± 2% MEW (viscosity less than 2cSt)		
Repeatability	± 0.5% MEW		
Temperature Monitoring			
Accuracy	± 1K		
Reaction Times			
Flow Monitoring			
Response Time	1 second; (dAP = 0)		
Damping for the Switching Output dAP	0 to 5 seconds		
Temperature Monitoring			
Dynamic Response T05 / T09	T09 = 6 seconds		
Environment			
Ambient Temperature***	32 to 140°F (0 to 60°C)		
Storage Temperature	-4 to 176°F (-20 to 80°C)		
Protection	IP 65; IP 67		
* Measuring Range minimum flow rate at <2 cSt. For higher viscosities see Viscosity/Minimum Flow Rate chart.			
** For viscosities from 2 to 4 cSt, accuracy is 3% of full range and from 4 to 14 cSt, accuracy is 4% of full range.			
*** Medium Temperature < 176°F (80°C); Ambient 32 to 140°F (0 to 60°C)			
Medium Temperature < 194°F (90°C); Ambient 32 to 122°F (0 to 50°C)			
MEW = Final value of the measuring range			

ProSense® VFS Series (-1001) Vortex Flow Sensors

ProSense VFS Series (-1001) Vortex Flow Sensors			
Model	VFS50-5-1001	VFS50-10-1001	VFS75-26-1001
Mechanical Data			
Weight	1.06 lbs	1.03 lbs	1.11 lbs
Process Connection	1/2" NPT female rotatable	1/2" NPT female rotatable	3/4" NPT female rotatable
Materials (wetted parts)	Stainless steel (1.4404 / 316L); ETFE; PA 6T; PPS; FKM		
Housing Materials	Stainless steel (1.4404 / 316L); PC; PBT+PC-GF30; PPS; TPE-U		
Tightening Torque	30Nm		
Displays / Operating Elements			
Display	25 x 25mm TFT LCD 2 x Orange LEDs		
Electrical Connection			
Connection	M12 connector; gold-plated contacts		
Tests / Approvals			
EMC	DIN EN 61000-6-2 DIN EN 61000-6-3		
Shock Resistance	DIN EN 60068-2-27: 5g (11ms)		
Vibration Resistance	DIN EN 60068-2-6: With water / 10 to 50 Hz 1mm DIN EN 60068-2-6: With water / 50 to 2,000 Hz 2g		
Pressure Equipment Directive	For group 2 fluids in accordance with sound engineering practices		
UL Approval	E320431		
CE	EMC; RoHS II		
To obtain the most current agency approval information, see the Agency Approval Checklist section on the specific part number's web page at www.automationdirect.com			



Note: Check the chemical compatibility of the sensor's wetted parts with the medium to be measured.

Wiring Diagram

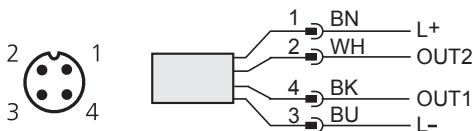

Cable Assembly Wiring Colors:
Pin 1 - Brown
Pin 2 - White
Pin 3 - Blue
Pin 4 - Black

Colors to DIN EN 60947-5-2

For additional wiring details see individual product manuals.

Note: Wiring colors are based on AutomationDirect CD12L and CD12M 4-pole cable assemblies.

Output Function Selections

Output 1:
Flow monitoring
Switching output
Frequency output

Output 2:
Flow monitoring or temperature monitoring
Switching output
Frequency output



Click or scan the above QR code to be taken to the installation insert for the VFS1001 Series Vortex Flow Sensors

pro^{ense} VFS Series (-1001) Vortex Flow Sensors

Pressure Loss

VFS50-5-1001

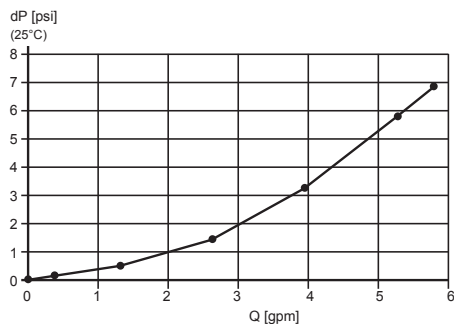

VFS50-10-1001

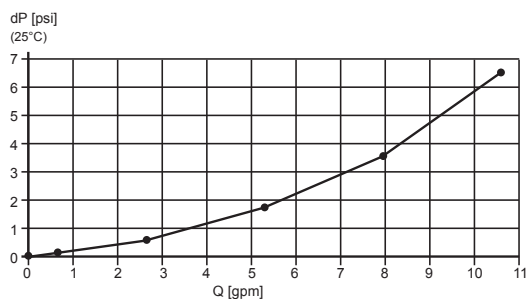

VFS75-26-1001

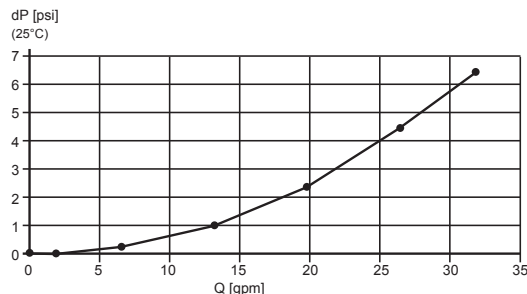

Pressure Rating

VFS50-5-1001
VFS50-10-1001
VFS75-26-1001

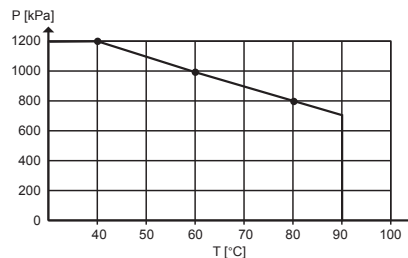

Viscosity/Minimum Flow Rate

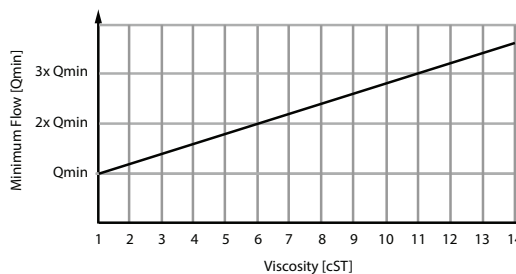

Dimensions

mm [inches]

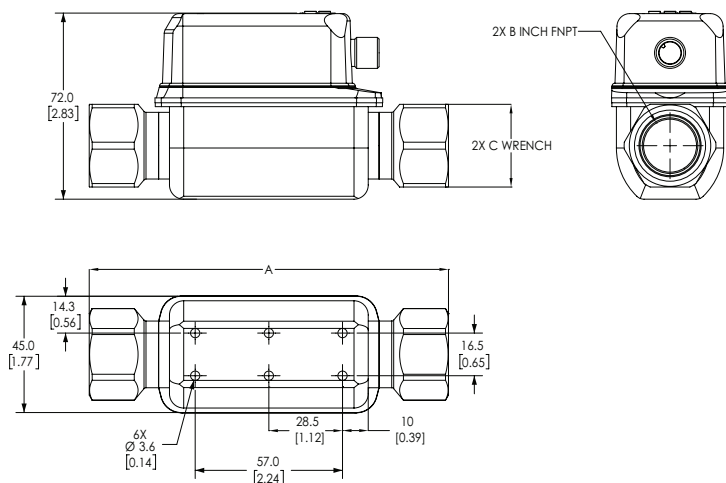

Model	A	B	C
VFS50-5-1001	119.0 [4.69]	1/2" FNPT	27.0 [1.06]
VFS50-10-1001	119.0 [4.69]	1/2" FNPT	27.0 [1.06]
VFS75-26-1001	139.0 [5.47]	3/4" FNPT	32.0 [1.26]

See our website www.AutomationDirect.com for complete Engineering drawings.

proSense® VFS Series Vortex Flow Sensors



Vortex Flow Sensor Measuring Principle

Vortex shedding or vortex flow sensing technology is based on the principle that liquid flow will produce alternating vortices downstream when passing by an obstacle in the flow. Inside of a vortex sensor the obstacle is a bluff body that has a broad, flat front and extends vertically in the center of the sensor. As the liquid flow reaches a certain velocity, alternating vortices form behind the bluff body, detach or shed from the bluff body, and flow downstream. A piezoceramic sensor in the sensor detects these vortices and the sensor electronics determine the flow velocity based on the frequency of the vortices. Because the cross-sectional area inside the meter is known, it can be used by the sensor to determine flow rate.

The vortex flow principle is a simple, low cost, and proven method for measuring flow of water-based liquids that is independent of the liquid's pressure or temperature fluctuations.

Vortex Flow Sensor Measuring Principle

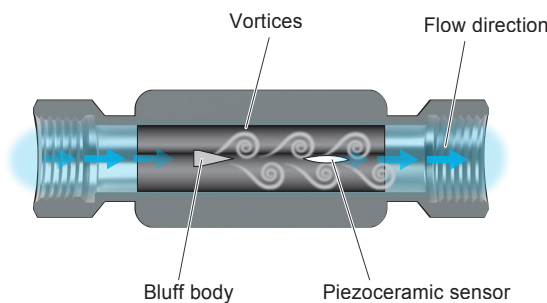

VFS Series Vortex Flow Sensor Features



ProSense VFS Series Vortex Flow Sensor Selection Guide							
Model	Price	Process Connection	Flow Range	Temperature Range	Display Units	Output 1	Output 2
<u>VFS50-5-1001</u>	\$223.00	1/2" NPT female	0.26 to 5.28 GPM (16 to 317 GPH)	14 to 194°F	Switching status: 2 x LED, orange Measured values: alphanumeric TFT color display	PNP/NPN Switch or frequency (flow)	PNP/NPN Switch or frequency (flow or temperature)
<u>VFS50-10-1001</u>	\$223.00		0.55 to 10.55 GPM (32 to 634 GPH)				
<u>VFS75-26-1001</u>	\$240.00	3/4" NPT female	1.3 to 26.4 GPM (80 to 1585 GPH)				
<u>VFS50-5-1002</u>	\$223.00	1/2" NPT female	0.26 to 5.28 GPM (16 to 317 GPH)		Measured values: alphanumeric TFT color display	4 to 20 mA scalable analog (temperature)	4 to 20 mA scalable analog (flow)
<u>VFS50-10-1002</u>	\$223.00		0.55 to 10.55 GPM (32 to 634 GPH)				
<u>VFS75-26-1002</u>	\$240.00	3/4" NPT female	1.3 to 26.4 GPM (80 to 1585 GPH)				