

UK1 Series Ultrasonic Sensors



UK1A-G1-1E

M18 (18mm) Metal – Discrete or Analog Output

- Discrete models available with adjustable sensitivity
- Analog output models available
- Models available with analog and discrete switching outputs
- Several units can be synchronized for multi-point inspection
- IP67 rated
- LED status indicators
- Mounting hex nuts included
- Purchase cable for M12 plug separately
- Lifetime warranty



UK1A Series Ultrasonic Discrete or Analog Output Sensor Selection Chart

| Part Number | Price | Sensing Range | Output State | Connection | Wiring | Function |
|----------------------------|----------|------------------------------------|---|----------------------|-----------|----------|
| UK1A-GN-1E | \$136.00 | 50 to 400 mm [1.97 to 15.75 in] | NPN, N.O./N.C. selectable | M12 quick-disconnect | Diagram 1 | 1 |
| UK1A-GP-1E | \$136.00 | | PNP, N.O./N.C. selectable | M12 quick-disconnect | Diagram 2 | 1 |
| UK1A-GW-1E | \$142.00 | | PNP, 2 N.O./N.C. selectable | M12 quick-disconnect | Diagram 3 | 3 |
| UK1A-G1-1E | \$140.00 | | 0-10 VDC analog output | M12 quick-disconnect | Diagram 4 | 2 |
| UK1A-G2-1E | \$140.00 | | 4-20mA analog output | M12 quick-disconnect | Diagram 4 | 2 |
| UK1A-G6-1E | \$145.00 | | 4-20mA analog output, PNP, N.O./N.C. selectable | M12 quick-disconnect | Diagram 5 | 4 |
| UK1A-G7-1E | \$145.00 | | 0-10 VDC analog output, PNP, N.O./N.C. selectable | M12 quick-disconnect | Diagram 5 | 4 |

UK1C Series Ultrasonic Discrete or Analog Output Sensor Selection Chart

| Part Number | Price | Sensing Range | Output State | Connection | Wiring | Function |
|----------------------------|----------|------------------------------------|---|----------------------|-----------|----------|
| UK1C-GN-1E | \$142.00 | 80 to 900 mm [3.15 to 35.43 in] | NPN, N.O./N.C. selectable | M12 quick-disconnect | Diagram 1 | 1 |
| UK1C-GP-1E | \$142.00 | | PNP, N.O./N.C. selectable | M12 quick-disconnect | Diagram 2 | 1 |
| UK1C-GW-1E | \$150.00 | | PNP, 2 N.O./N.C. selectable | M12 quick-disconnect | Diagram 3 | 3 |
| UK1C-G1-1E | \$142.00 | | 0 to 10 VDC analog output | M12 quick-disconnect | Diagram 4 | 2 |
| UK1C-G2-1E | \$142.00 | | 4-20mA analog output | M12 quick-disconnect | Diagram 4 | 2 |
| UK1C-G6-1E | \$150.00 | | 4-20mA analog output, PNP, N.O./N.C. selectable | M12 quick-disconnect | Diagram 5 | 4 |
| UK1C-G7-1E | \$150.00 | | 0-10 VDC analog output, PNP, N.O./N.C. selectable | M12 quick-disconnect | Diagram 5 | 4 |

UK1D Series Ultrasonic Discrete or Analog Output Sensor Selection Chart

| Part Number | Price | Sensing Range | Output State | Connection | Wiring | Function |
|----------------------------|----------|-------------------------------------|---|----------------------|-----------|----------|
| UK1D-GN-1E | \$145.00 | 150 to 1600mm [5.90 to 62.99 in] | NPN, N.O./N.C. selectable | M12 quick-disconnect | Diagram 1 | 1 |
| UK1D-GP-1E | \$145.00 | | PNP, N.O./N.C. selectable | M12 quick-disconnect | Diagram 2 | 1 |
| UK1D-GW-1E | \$150.00 | | PNP, 2 N.O./N.C. selectable | M12 quick-disconnect | Diagram 3 | 3 |
| UK1D-G1-1E | \$142.00 | | 0-10 VDC analog output | M12 quick-disconnect | Diagram 4 | 2 |
| UK1D-G2-1E | \$142.00 | | 4-20mA analog output | M12 quick-disconnect | Diagram 4 | 2 |
| UK1D-G6-1E | \$151.00 | | 4-20mA analog output, PNP, N.O./N.C. selectable | M12 quick-disconnect | Diagram 5 | 4 |
| UK1D-G7-1E | \$148.00 | | 0-10 VDC analog output, PNP, N.O./N.C. selectable | M12 quick-disconnect | Diagram 5 | 4 |

UK1F Series Ultrasonic Discrete or Analog Output Sensor Selection Chart

| Part Number | Price | Sensing Range | Output State | Connection | Wiring | Function |
|----------------------------|----------|--------------------------------------|---|----------------------|-----------|----------|
| UK1F-GN-1E | \$159.00 | 200 to 2200 mm [7.87 to 86.61 in] | NPN, N.O./N.C. selectable | M12 quick-disconnect | Diagram 1 | 1 |
| UK1F-GP-1E | \$159.00 | | PNP, N.O./N.C. selectable | M12 quick-disconnect | Diagram 2 | 1 |
| UK1F-GW-1E | \$159.00 | | PNP, 2 N.O./N.C. selectable | M12 quick-disconnect | Diagram 3 | 3 |
| UK1F-G1-1E | \$159.00 | | 0-10 VDC analog output | M12 quick-disconnect | Diagram 4 | 2 |
| UK1F-G2-1E | \$159.00 | | 4-20mA analog output | M12 quick-disconnect | Diagram 4 | 2 |
| UK1F-G6-1E | \$159.00 | | 4-20mA analog output, PNP, N.O./N.C. selectable | M12 quick-disconnect | Diagram 5 | 4 |
| UK1F-G7-1E | \$159.00 | | 0-10 VDC analog output, PNP, N.O./N.C. selectable | M12 quick-disconnect | Diagram 5 | 4 |

UK1 Series Ultrasonic Sensors

| UK1 Series Specifications | | | | |
|-------------------------------------|--|------------------------------------|-----------------------------------|-----------------------------------|
| Model | UK1A | UK1C | UK1D | UK1F |
| Nominal Sensing Distance | 50-400 mm [1.97 to 15.75 in] | 80 to 900 mm [3.15 to 35.43 in] | 150-1600 mm [5.90 to 62.99 in] | 200-2200 mm [7.87 to 86.61 in] |
| Operating Distance (Sensing Range) | 50-400 mm [1.97 to 15.75 in] | 80 to 900 mm [3.15 to 35.43 in] | 150-1600 mm [5.90 to 62.99 in] | 200-2200 mm [7.87 to 86.61 in] |
| Output Type | See "Output State" column in selection chart | | | |
| Operating Voltage | 10-30 VDC | | | |
| No-load Supply Current | ≤ 50mA | | | |
| Operating (Load) Current | 100mA | | | |
| Off-state (Leakage) Current | 10µA @ 30VDC | | | |
| Analog Output | Voltage: minimum load is 3kΩ / Current: maximum load is 500Ω at 24VDC supply | | | |
| Voltage Drop | 2.2 V max @ 100mA | | | |
| Switching Frequency | 10Hz | 4Hz | 3Hz | 1Hz |
| Repeat Accuracy | 0.5% | | | |
| Time Delay Before Availability (tv) | ≤ 300ms | | | |
| Reverse Polarity Protection | Yes | | | |
| Short-Circuit Protection | Yes | | | |
| Linearity Error | 1% | | | |
| Ultrasonic Frequency | 300kHz | 300kHz | 230kHz | 200kHz |
| Ultrasonic Beam Angle | 10° ± 2° | 10° ± 2° | 7° ± 2° | 14° ± 2° |
| Max. Response Time (digital output) | 500ms | 500ms | 500ms | 500ms |
| Sensitivity Adjustment | Yes, via teach-in button | | | |
| Input Voltage Transient Protection | Yes | | | |
| Operating Temperature | -20 to 70°C [-4 to 158°F] | | | |
| Temperature Compensation | Yes | | | |
| Protection Degree | IEC IP67 | | | |
| Indication/Switch Status | Multi-function LED indicator | | | |
| Housing Material | 316L stainless steel | | | |
| Shock/Vibration | IEC 69047-5-2/7.4 | | | |
| Tightening Torque | 50 N·m [36.88 lb·ft] | | | |
| Weight | 55g [1.94 oz] [plug exit] | | | |
| Connection | M12 [12mm] connector | | | |
| Agency Approvals | CE, cULus file E187310 | | | |

Wiring Diagrams

Diagram 1

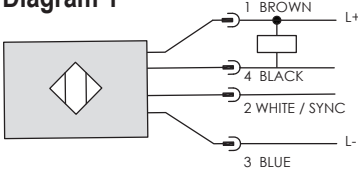

Diagram 2

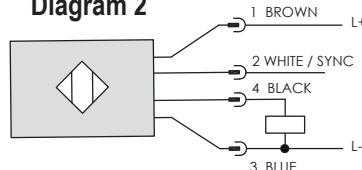

Diagram 3

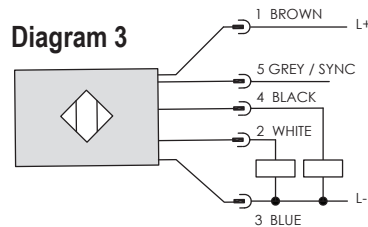

Diagram 4

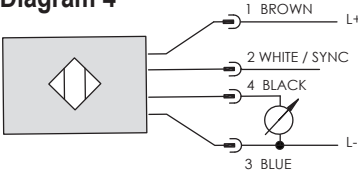
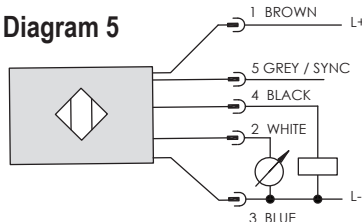
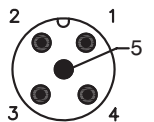
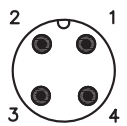

Diagram 5



Connector

M12 connector



UK1 Series Ultrasonic Sensors

Dimensions

mm [inches]

UK1 Series Metal M12 Quick Disconnect

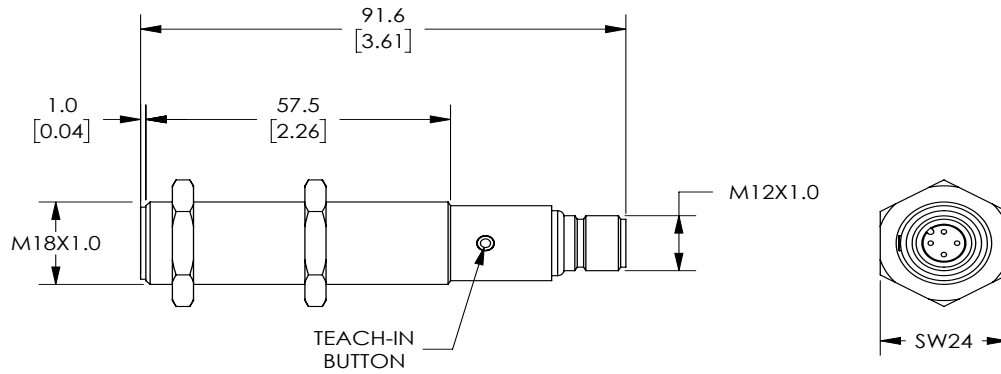

UK1 Series Ultrasonic Sensors

Characteristic Curves

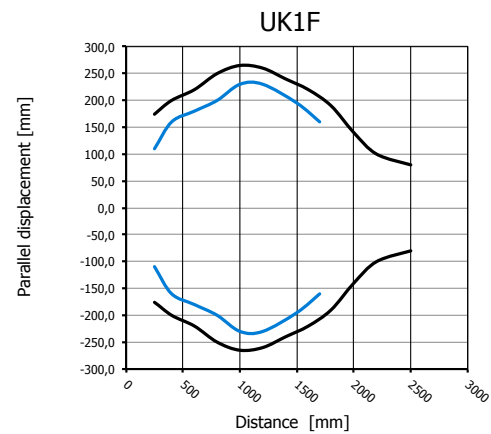
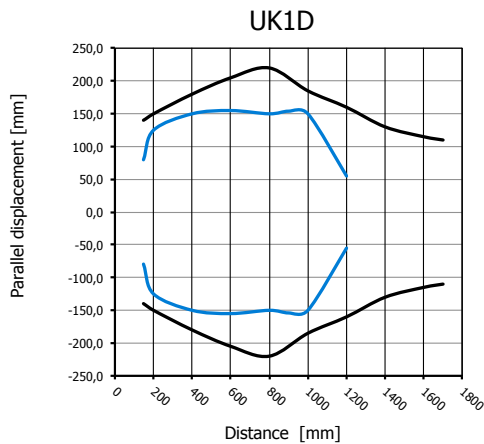
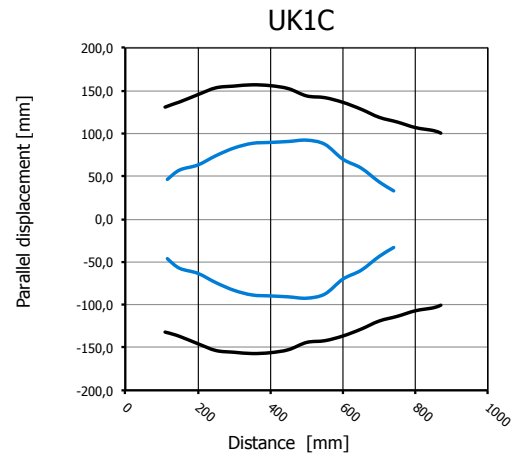
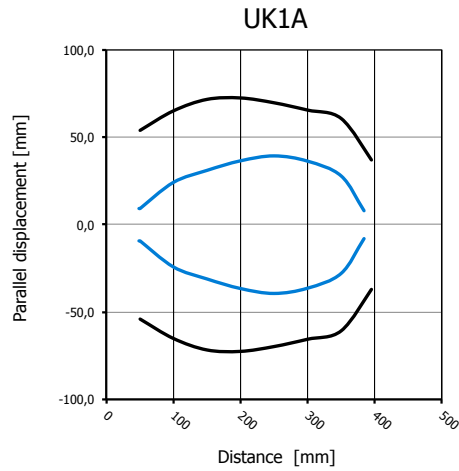

UK1 Series Ultrasonic Sensors

Functions

Models with single digital output

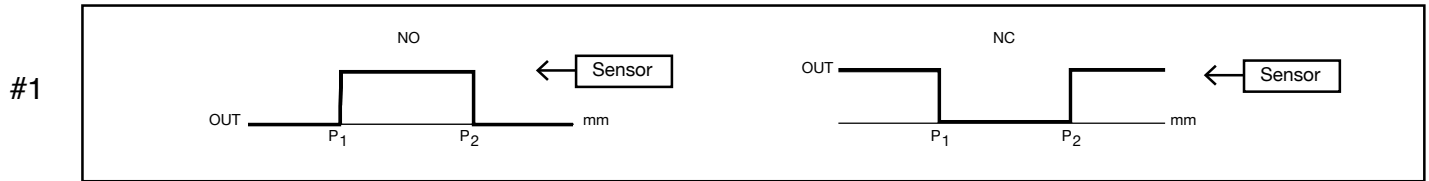

Models with single analog output

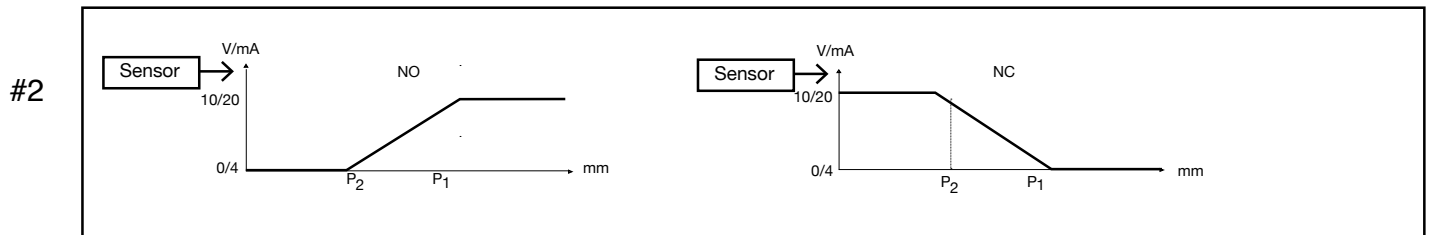

Models with double digital output

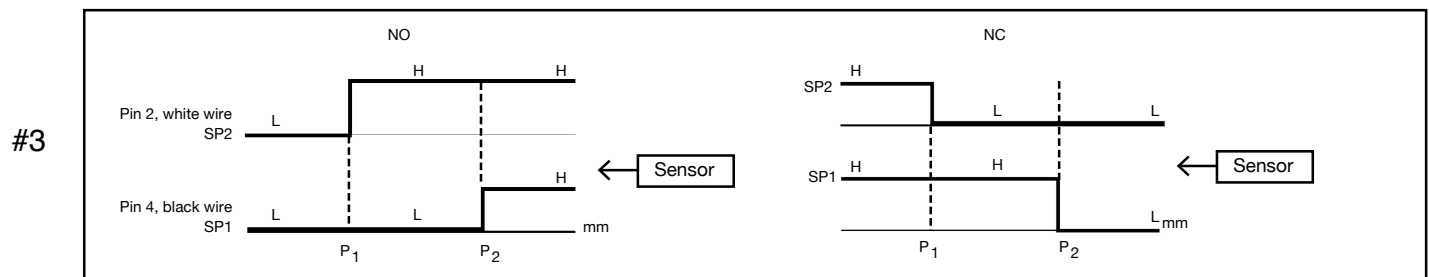

Models with digital output + analog output

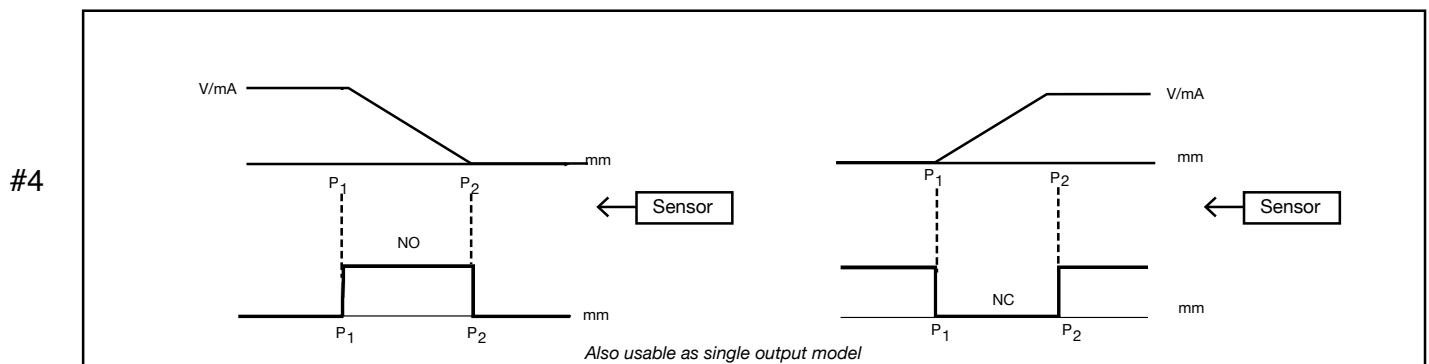

Note: P1 maximum selected working distance and first point to select
 P2 minimum selected working distance and second point to select

Accessories for 18mm Sensors

Axial Mounting Bracket

Axial mounting bracket available in zinc plated steel or 316L stainless steel. Has two mounting holes (use 4mm screws) and allows for rotation of an optical axis for right-beam-angle-adaptor sensors. Hexagonal nuts not included. For use with 18mm sensors.



ST18A

| Accessories for 18mm Sensors | | | |
|------------------------------|--------|---|---------------|
| Part Number | Price | Description | Weight lb [g] |
| ST18A | \$2.00 | Micro Detectors mounting bracket, axial, zinc plated steel. For use with 18mm sensors. | 0.06 [27.2] |
| ST18A7W | \$7.25 | Micro Detectors mounting bracket, axial, 316L stainless steel. For use with 18mm sensors. | 0.06 [27.2] |

Dimensions

mm [inches]

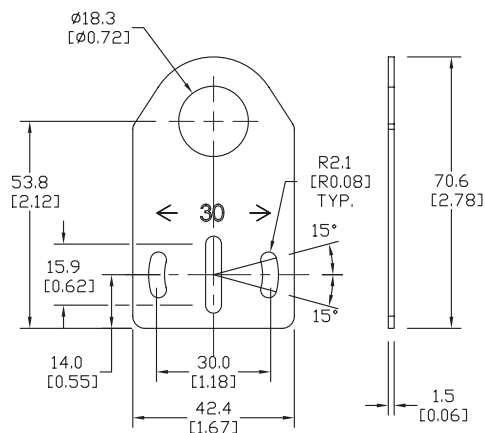

Right-angle Mounting Bracket

Right-angle mounting bracket for use with 18mm sensors. Has two mounting holes (use 4mm screws) and allows the rotation of an optical axis for axial sensors. Hexagonal nuts not included.



ST18C

| Accessories for 18mm Sensors | | | |
|------------------------------|--------|---|---------------|
| Part Number | Price | Description | Weight lb [g] |
| ST18C | \$2.00 | Micro Detectors mounting bracket, right-angle, zinc plated steel. For use with 18mm sensors. | 0.06 [27.2] |
| ST18C7W | \$7.25 | Micro Detectors mounting bracket, right-angle, 316L stainless steel. For use with 18mm sensors. | 0.06 [27.2] |

Dimensions

mm [inches]

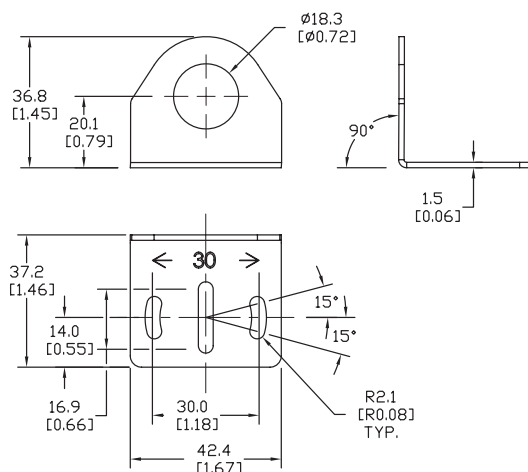

Accessories for 18mm Sensors

Right-angle Mounting Brackets

Mounting bracket, right-angle, fixed insertion stop adjustment, plastic. For use with 18mm sensors. Available with or without fixed insertion stop.

| Accessories for 18mm Sensors | | | | |
|------------------------------|---------|---|---------------------|---------------|
| Part Number | Price | Description | Drawing Link | Weight lb [g] |
| OPT2104 | \$10.50 | Wenglor mounting bracket, right-angle, fixed insertion stop adjustment, plastic. For use with 18mm sensors. | PDF | 0.06 [27.2] |
| OPT2105 | \$10.50 | Wenglor mounting bracket, right-angle, plastic. For use with 18mm sensors. | PDF | 0.06 [27.2] |



[OPT2104](#), [OPT2105](#)

Right-angle Swivel Mounting Systems

Mounting bracket, right-angle swivel, 360 degree vertical and horizontal adjustment, 12mm rod mount. For use with 18mm sensors. Available in all 304 stainless steel or with an aluminum head and a stainless steel mounting plate.

| Accessories for 18mm Sensors | | | | | | |
|------------------------------|---------|--|---------------------|---------------------|---------------------|---------------|
| Part Number | Price | Description | Mounting Head | Mounting Plate | Drawing Link | Weight lb [g] |
| OPT2116 | \$11.50 | Wenglor mounting bracket, right-angle swivel, 360 degree vertical and horizontal adjustment, aluminum, 12mm rod mount. For use with 18mm sensors. | Aluminum | 304 Stainless steel | PDF | 0.15 [68.0] |
| OPT2117 | \$21.00 | Wenglor mounting bracket, right-angle swivel, 360 degree vertical and horizontal adjustment, 304 stainless steel, 12mm rod mount. For use with 18mm sensors. | 304 Stainless steel | 304 Stainless steel | PDF | 0.28 [127.0] |



[OPT2116](#), [OPT2117](#)

Note: 304 Stainless steel mounting rods sold separately: [OPT2109](#) (200mm [7.87 in] length), [OPT2110](#) (300mm [11.81 in] length), and [OPT2111](#) (500mm [19.69 in] length).

Mounting Rods and Brackets

Mounting Rods

304 Stainless steel rods for mounting swivel brackets [OPT2112](#) - [OPT2127](#). Available in three lengths: 200mm, 300mm, and 500mm. 12mm diameter.

| Mounting Rods for OPT2112-2127 Swivel Mounting Brackets | | | | |
|---|---------|---|---------------------|------------------|
| Part Number | Price | Description | Drawing Link | Weight lb (g) |
| OPT2109 | \$13.00 | Wenglor mounting rod, 12mm diameter, 200mm length, 304 stainless steel. | PDF | 0.41 [185.97] |
| OPT2110 | \$16.00 | Wenglor mounting rod, 12mm diameter, 300mm length, 304 stainless steel. | PDF | 0.60 [272.16] |
| OPT2111 | \$21.00 | Wenglor mounting rod, 12mm diameter, 500mm length, 304 stainless steel. | PDF | 0.98 [444.52] |



Right-angle Mounting Bracket

Mounting bracket, right-angle, nickel-plated brass. For use with 12mm mounting rods [OPT2109](#), [OPT2110](#) & [OPT2111](#).

| Right-angle Mounting Brackets for 12mm Sensors | | | | |
|--|---------|---|---------------------|----------------|
| Part Number | Price | Description | Drawing Link | Weight lb [g] |
| OPT2108 | \$16.00 | Wenglor mounting bracket, right-angle, nickel-plated brass. For use with 12mm mounting rods OPT2109 , OPT2110 & OPT2111 . | PDF | 0.07 [31.8] |

