

UK1 Series Ultrasonic Sensors

M18 (18mm) Metal – Discrete or Analog Output



UK1A-G1-1E

- Discrete models available with adjustable sensitivity
- Analog output models available
- Models available with analog and discrete switching outputs
- Several units can be synchronized for multi-point inspection
- IP67 rated
- LED status indicators
- Mounting hex nuts included
- Purchase cable for M12 plug separately
- Lifetime warranty



UK1A Series Ultrasonic Discrete or Analog Output Sensor Selection Chart						
Part Number	Price	Sensing Range	Output State	Connection	Wiring	Function
UK1A-GN-1E	\$136.00	50 to 400 mm [1.97 to 15.75 in]	NPN, N.O./N.C. selectable	M12 quick-disconnect	Diagram 1	1
UK1A-GP-1E	\$136.00		PNP, N.O./N.C. selectable	M12 quick-disconnect	Diagram 2	1
UK1A-GW-1E	\$142.00		PNP, 2 N.O./N.C. selectable	M12 quick-disconnect	Diagram 3	3
UK1A-G1-1E	\$140.00		0-10 VDC analog output	M12 quick-disconnect	Diagram 4	2
UK1A-G2-1E	\$140.00		4-20mA analog output	M12 quick-disconnect	Diagram 4	2
UK1A-G6-1E	\$145.00		4-20mA analog output, PNP, N.O./N.C. selectable	M12 quick-disconnect	Diagram 5	4
UK1A-G7-1E	\$145.00		0-10 VDC analog output, PNP, N.O./N.C. selectable	M12 quick-disconnect	Diagram 5	4

UK1C Series Ultrasonic Discrete or Analog Output Sensor Selection Chart						
Part Number	Price	Sensing Range	Output State	Connection	Wiring	Function
UK1C-GN-1E	\$142.00	80 to 900 mm [3.15 to 35.43 in]	NPN, N.O./N.C. selectable	M12 quick-disconnect	Diagram 1	1
UK1C-GP-1E	\$142.00		PNP, N.O./N.C. selectable	M12 quick-disconnect	Diagram 2	1
UK1C-GW-1E	\$150.00		PNP, 2 N.O./N.C. selectable	M12 quick-disconnect	Diagram 3	3
UK1C-G1-1E	\$142.00		0 to 10 VDC analog output	M12 quick-disconnect	Diagram 4	2
UK1C-G2-1E	\$142.00		4-20mA analog output	M12 quick-disconnect	Diagram 4	2
UK1C-G6-1E	\$150.00		4-20mA analog output, PNP, N.O./N.C. selectable	M12 quick-disconnect	Diagram 5	4
UK1C-G7-1E	\$150.00		0-10 VDC analog output, PNP, N.O./N.C. selectable	M12 quick-disconnect	Diagram 5	4

UK1D Series Ultrasonic Discrete or Analog Output Sensor Selection Chart						
Part Number	Price	Sensing Range	Output State	Connection	Wiring	Function
UK1D-GN-1E	\$145.00	150 to 1600mm [5.90 to 62.99 in]	NPN, N.O./N.C. selectable	M12 quick-disconnect	Diagram 1	1
UK1D-GP-1E	\$145.00		PNP, N.O./N.C. selectable	M12 quick-disconnect	Diagram 2	1
UK1D-GW-1E	\$150.00		PNP, 2 N.O./N.C. selectable	M12 quick-disconnect	Diagram 3	3
UK1D-G1-1E	\$142.00		0-10 VDC analog output	M12 quick-disconnect	Diagram 4	2
UK1D-G2-1E	\$142.00		4-20mA analog output	M12 quick-disconnect	Diagram 4	2
UK1D-G6-1E	\$151.00		4-20mA analog output, PNP, N.O./N.C. selectable	M12 quick-disconnect	Diagram 5	4
UK1D-G7-1E	\$148.00		0-10 VDC analog output, PNP, N.O./N.C. selectable	M12 quick-disconnect	Diagram 5	4

UK1F Series Ultrasonic Discrete or Analog Output Sensor Selection Chart						
Part Number	Price	Sensing Range	Output State	Connection	Wiring	Function
UK1F-GN-1E	\$159.00	200 to 2200 mm [7.87 to 86.61 in]	NPN, N.O./N.C. selectable	M12 quick-disconnect	Diagram 1	1
UK1F-GP-1E	\$159.00		PNP, N.O./N.C. selectable	M12 quick-disconnect	Diagram 2	1
UK1F-GW-1E	\$159.00		PNP, 2 N.O./N.C. selectable	M12 quick-disconnect	Diagram 3	3
UK1F-G1-1E	\$159.00		0-10 VDC analog output	M12 quick-disconnect	Diagram 4	2
UK1F-G2-1E	\$159.00		4-20mA analog output	M12 quick-disconnect	Diagram 4	2
UK1F-G6-1E	\$159.00		4-20mA analog output, PNP, N.O./N.C. selectable	M12 quick-disconnect	Diagram 5	4
UK1F-G7-1E	\$159.00		0-10 VDC analog output, PNP, N.O./N.C. selectable	M12 quick-disconnect	Diagram 5	4

UK1 Series Ultrasonic Sensors

UK1 Series Specifications				
Model	UK1A	UK1C	UK1D	UK1F
Nominal Sensing Distance	50-400 mm [1.97 to 15.75 in]	80 to 900 mm [3.15 to 35.43 in]	150-1600 mm [5.90 to 62.99 in]	200-2200 mm [7.87 to 86.61 in]
Operating Distance (Sensing Range)	50-400 mm [1.97 to 15.75 in]	80 to 900 mm [3.15 to 35.43 in]	150-1600 mm [5.90 to 62.99 in]	200-2200 mm [7.87 to 86.61 in]
Output Type	See "Output State" column in selection chart			
Operating Voltage	10-30 VDC			
No-load Supply Current	≤ 50mA			
Operating (Load) Current	100mA			
Off-state (Leakage) Current	10µA @ 30VDC			
Analog Output	Voltage: minimum load is 3kΩ / Current: maximum load is 500Ω at 24VDC supply			
Voltage Drop	2.2 V max @ 100mA			
Switching Frequency	10Hz	4Hz	3Hz	1Hz
Repeat Accuracy	0.5%			
Time Delay Before Availability (tv)	≤ 300ms			
Reverse Polarity Protection	Yes			
Short-Circuit Protection	Yes			
Linearity Error	1%			
Ultrasonic Frequency	300kHz	300kHz	230kHz	200kHz
Ultrasonic Beam Angle	10° ± 2°	10° ± 2°	7° ± 2°	14° ± 2°
Max. Response Time (digital output)	500ms	500ms	500ms	500ms
Sensitivity Adjustment	Yes, via teach-in button			
Input Voltage Transient Protection	Yes			
Operating Temperature	-20 to 70°C [-4 to 158°F]			
Temperature Compensation	Yes			
Protection Degree	IEC IP67			
Indication/Switch Status	Multi-function LED indicator			
Housing Material	316L stainless steel			
Shock/Vibration	IEC 69047-5-2/7.4			
Tightening Torque	50 N·m [36.88 lb·ft]			
Weight	55g [1.94 oz] [plug exit]			
Connection	M12 [12mm] connector			
Agency Approvals	CE, cULus file E187310			

Wiring Diagrams

Diagram 1

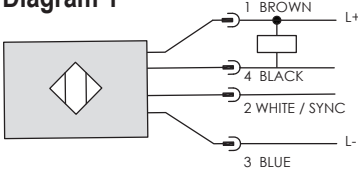

Diagram 2

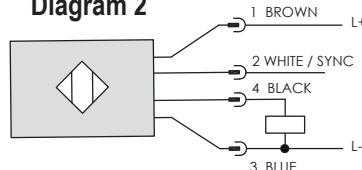

Diagram 3

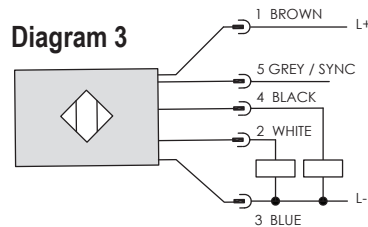

Diagram 4

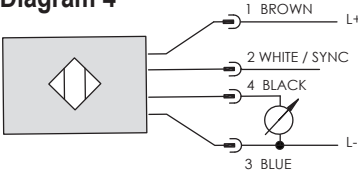
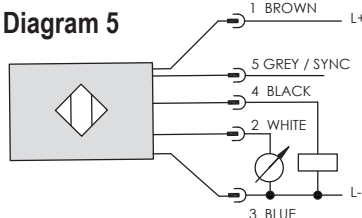
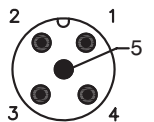
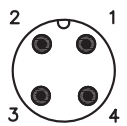

Diagram 5



Connector

M12 connector



UK1 Series Ultrasonic Sensors

Dimensions

mm [inches]

UK1 Series Metal M12 Quick Disconnect

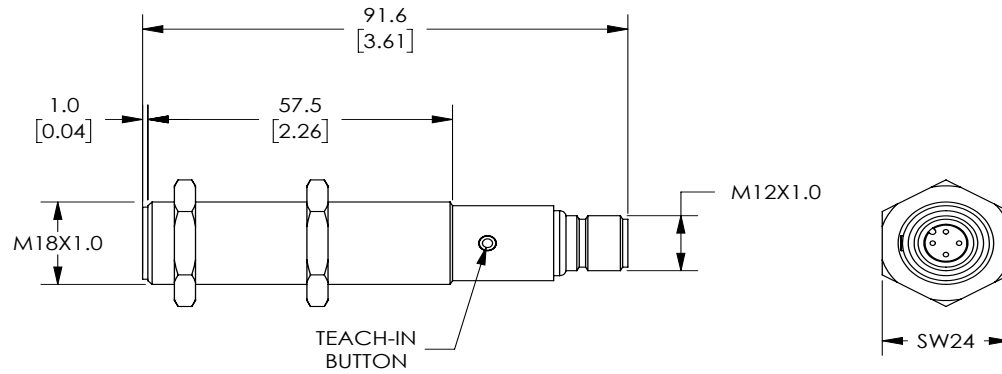

UK1 Series Ultrasonic Sensors

Characteristic Curves

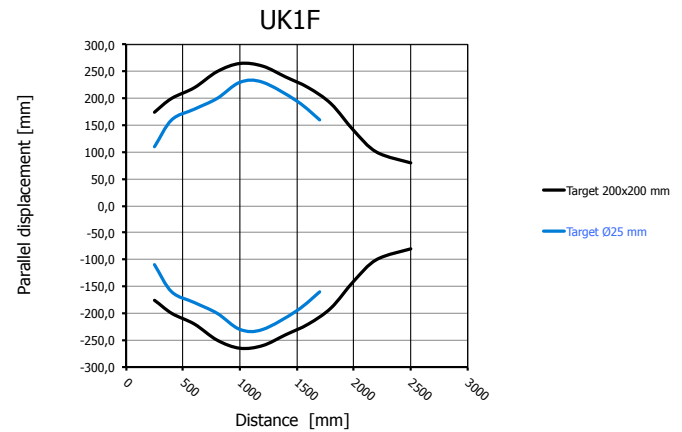
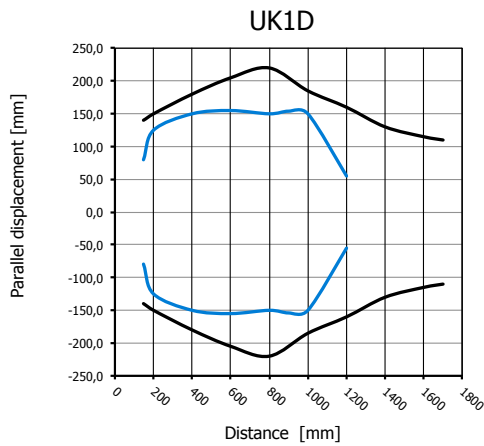
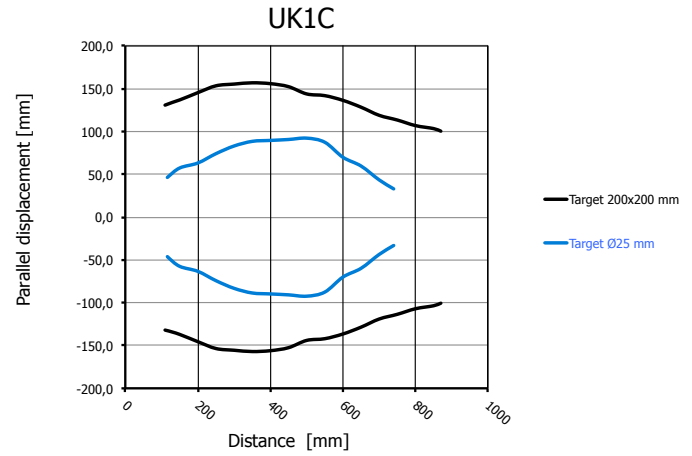
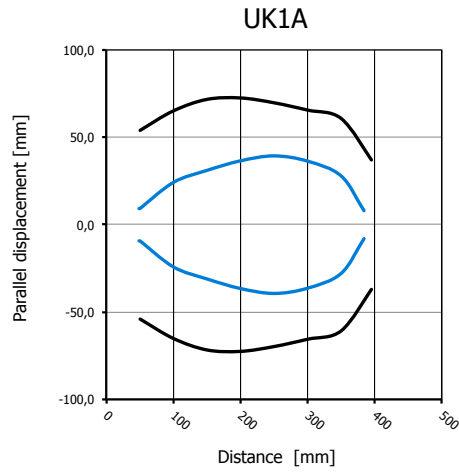

UK1 Series Ultrasonic Sensors

Functions

Models with single digital output

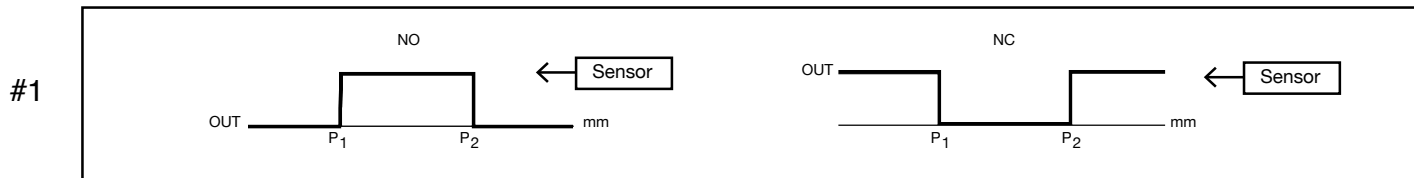

Models with single analog output

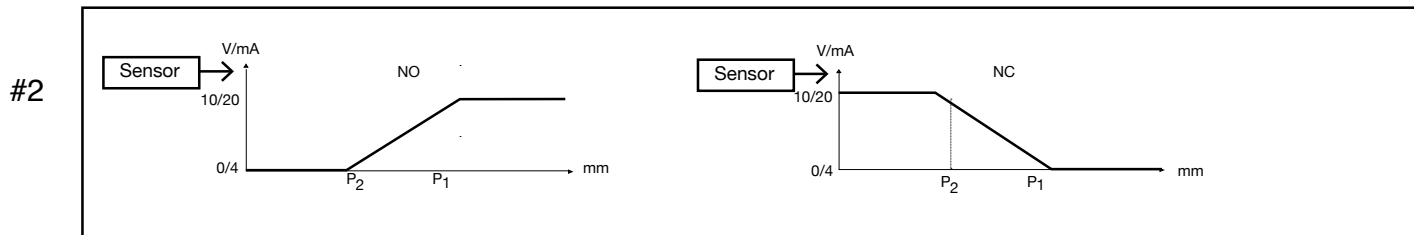

Models with double digital output

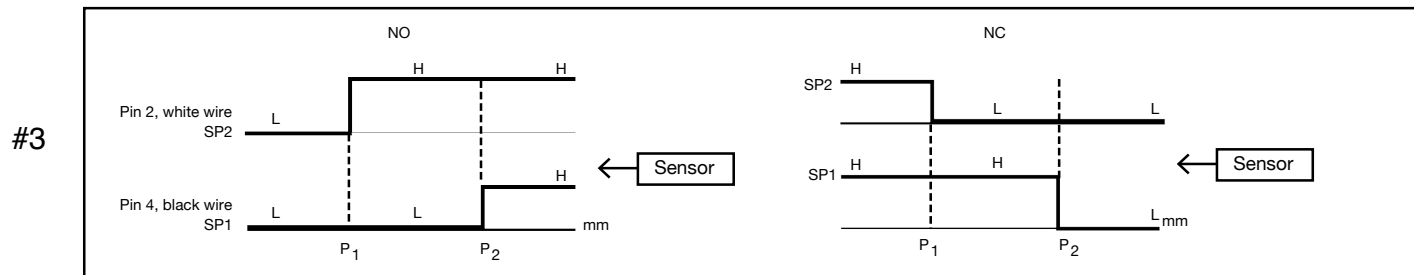

Models with digital output + analog output

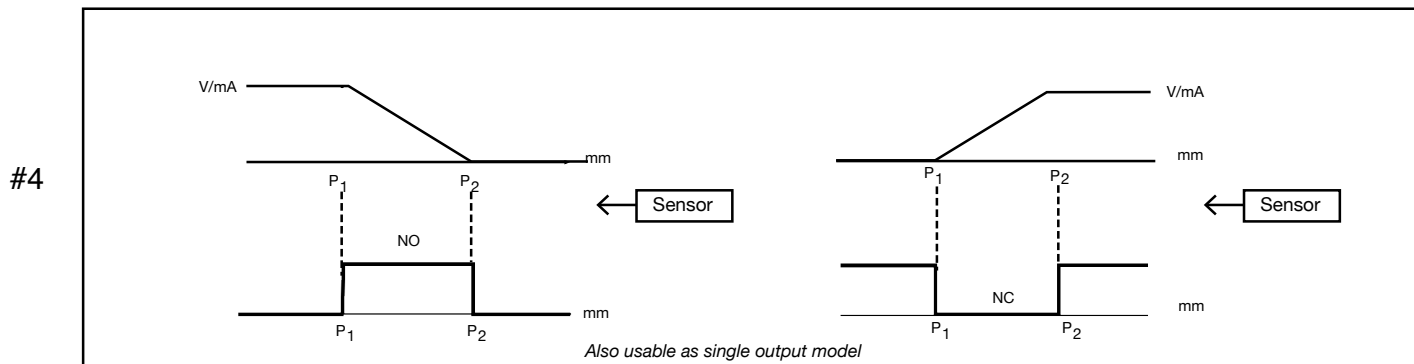

Note: P1 maximum selected working distance and first point to select
 P2 minimum selected working distance and second point to select

Accessories for 18mm Sensors

Axial Mounting Bracket

Axial mounting bracket available in zinc plated steel or 316L stainless steel. Has two mounting holes (use 4mm screws) and allows for rotation of an optical axis for right-beam-angle-adaptor sensors. Hexagonal nuts not included. For use with 18mm sensors.



ST18A

Accessories for 18mm Sensors			
Part Number	Price	Description	Weight lb [g]
ST18A	\$2.00	Micro Detectors mounting bracket, axial, zinc plated steel. For use with 18mm sensors.	0.06 [27.2]
ST18A7W	\$7.25	Micro Detectors mounting bracket, axial, 316L stainless steel. For use with 18mm sensors.	0.06 [27.2]

Dimensions

mm [inches]

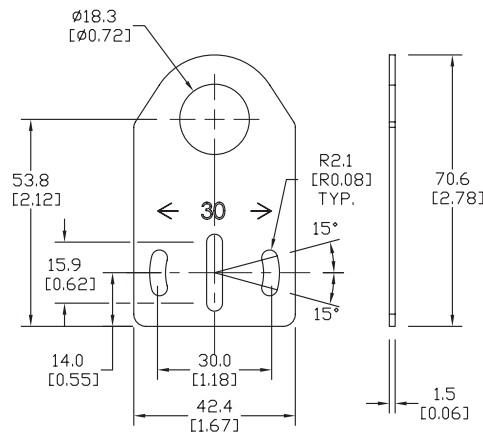

Right-angle Mounting Bracket

Right-angle mounting bracket for use with 18mm sensors. Has two mounting holes (use 4mm screws) and allows the rotation of an optical axis for axial sensors. Hexagonal nuts not included.



ST18C

Accessories for 18mm Sensors			
Part Number	Price	Description	Weight lb [g]
ST18C	\$2.00	Micro Detectors mounting bracket, right-angle, zinc plated steel. For use with 18mm sensors.	0.06 [27.2]
ST18C7W	\$7.25	Micro Detectors mounting bracket, right-angle, 316L stainless steel. For use with 18mm sensors.	0.06 [27.2]

Dimensions

mm [inches]

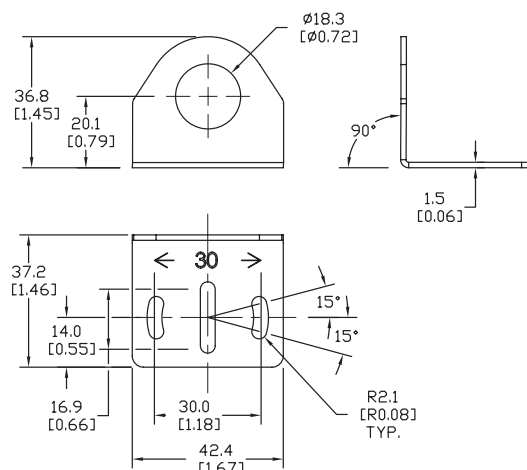

Accessories for 18mm Sensors

Right-angle Mounting Brackets

Mounting bracket, right-angle, fixed insertion stop adjustment, plastic. For use with 18mm sensors. Available with or without fixed insertion stop.

Accessories for 18mm Sensors				
Part Number	Price	Description	Drawing Link	Weight lb [g]
OPT2104	\$10.50	Wenglor mounting bracket, right-angle, fixed insertion stop adjustment, plastic. For use with 18mm sensors.	PDF	0.06 [27.2]
OPT2105	\$10.50	Wenglor mounting bracket, right-angle, plastic. For use with 18mm sensors.	PDF	0.06 [27.2]



[OPT2104](#), [OPT2105](#)

Right-angle Swivel Mounting Systems

Mounting bracket, right-angle swivel, 360 degree vertical and horizontal adjustment, 12mm rod mount. For use with 18mm sensors. Available in all 304 stainless steel or with an aluminum head and a stainless steel mounting plate.

Accessories for 18mm Sensors						
Part Number	Price	Description	Mounting Head	Mounting Plate	Drawing Link	Weight lb [g]
OPT2116	\$11.50	Wenglor mounting bracket, right-angle swivel, 360 degree vertical and horizontal adjustment, aluminum, 12mm rod mount. For use with 18mm sensors.	Aluminum	304 Stainless steel	PDF	0.15 [68.0]
OPT2117	\$21.00	Wenglor mounting bracket, right-angle swivel, 360 degree vertical and horizontal adjustment, 304 stainless steel, 12mm rod mount. For use with 18mm sensors.	304 Stainless steel	304 Stainless steel	PDF	0.28 [127.0]



[OPT2116](#), [OPT2117](#)

Note: 304 Stainless steel mounting rods sold separately: [OPT2109](#) (200mm [7.87 in] length), [OPT2110](#) (300mm [11.81 in] length), and [OPT2111](#) (500mm [19.69 in] length).

Mounting Rods and Brackets

Mounting Rods

304 Stainless steel rods for mounting swivel brackets [OPT2112](#) - [OPT2127](#). Available in three lengths: 200mm, 300mm, and 500mm. 12mm diameter.

Mounting Rods for OPT2112-2127 Swivel Mounting Brackets				
Part Number	Price	Description	Drawing Link	Weight lb (g)
OPT2109	\$13.00	Wenglor mounting rod, 12mm diameter, 200mm length, 304 stainless steel.	PDF	0.41 [185.97]
OPT2110	\$16.00	Wenglor mounting rod, 12mm diameter, 300mm length, 304 stainless steel.	PDF	0.60 [272.16]
OPT2111	\$21.00	Wenglor mounting rod, 12mm diameter, 500mm length, 304 stainless steel.	PDF	0.98 [444.52]



Right-angle Mounting Bracket

Mounting bracket, right-angle, nickel-plated brass. For use with 12mm mounting rods [OPT2109](#), [OPT2110](#) & [OPT2111](#).

Right-angle Mounting Brackets for 12mm Sensors				
Part Number	Price	Description	Drawing Link	Weight lb [g]
OPT2108	\$16.00	Wenglor mounting bracket, right-angle, nickel-plated brass. For use with 12mm mounting rods OPT2109 , OPT2110 & OPT2111 .	PDF	0.07 [31.8]

