

Just a Few Applications Where Terminator I/O Fits

PLC systems

Terminator I/O, with its variety of DC and AC discrete, analog, analog-combination and specialty modules, fills the need for distributed I/O in any size PLC system. An Ethernet Remote Master (H2-ERM100 and H4-ERM100) from a DL205 or DL405 series PLC, paired with an Ethernet Base Controller (T1H-EBC100) at remote I/O locations can supply you with up to a maximum of sixteen Terminator I/O nodes per Ethernet Remote Master channel. With hot-swappable modules and each node capable of handling hundreds of I/O points, Terminator I/O increases the capability of the PLC system you're already using, at a price that won't push the budget of your project.

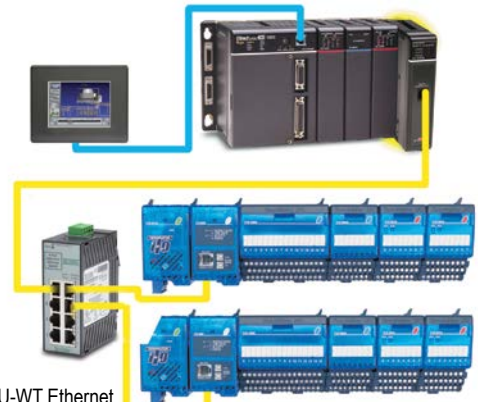

Use the SE-SW5U-WT Ethernet Switch for deterministic Ethernet control for your application.

PLC systems

SCADA systems

Terminator I/O can provide great low-cost I/O for your SCADA (Statistical Control and Data Acquisition) system. For example, a PC running KEPServerEX* Ethernet I/O OPC Server can monitor and control your distributed I/O via an Ethernet Base Controller (T1H-EBC100). Terminator I/O is also offered with DeviceNet, Modbus and Profibus interfaces. Terminator I/O's convenient, modular terminal bases are perfect for your remote I/O locations. Terminator I/O's slim profile and optional panel or DIN-rail mounting make it easy to install and wire the perfect combination of I/O in small junction boxes or other tight spaces close to your field devices.



SCADA Systems

* KEPServerEX may be purchased from Kepware and will support any existing applications. (<https://www.kepware.com/en-us/products/kepserverex>)

PC-based control systems

Terminator I/O is the clear choice for PC-based control I/O systems. Choose a network interface module and the I/O modules to meet your application's needs. Terminator I/O is compatible with several PC-based control packages, including Think & Do Studio and Think & Do Live! flowchart-based control software. Choose Think & Do Live!, add one of our industrial monitors to your PC, and you have a PC control system that is Ethernet-ready to connect to Terminator I/O.

PC-based control systems

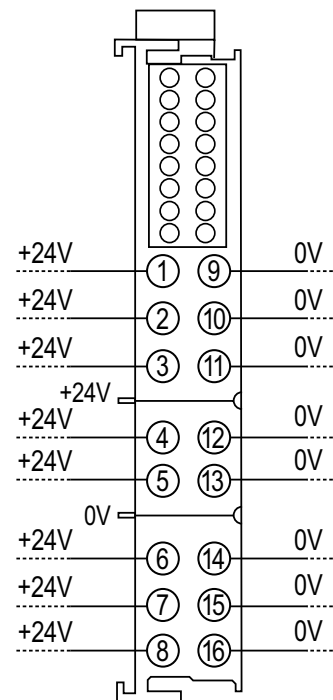

Terminator I/O

How it works:

Terminator I/O combines all the features of terminal blocks and I/O modules into one convenient package.

Achieve maximum system flexibility with our DIN rail mountable Terminator I/O system. Shorten wiring runs by locating I/O near field devices. Add modules in the future without buying new bases.

Our removable I/O modules connect internally to three-tier spring clamps or screw-type terminal blocks.

You'll save the cost of separate terminal blocks (and save the labor required to wire from traditional PLC I/O to separate terminal blocks). Maybe you need fused outputs? We offer those, too!

One of the best features of Terminator

I/O is its connectivity. We offer a choice of five plug-compatible network interface modules to connect you to your choice of network.

Each system needs at least one AC or DC power supply, but you can add more power if you need it. And, we offer a wide variety of discrete and analog I/O modules.

Building a system from Terminator I/O components

With Terminator I/O, you mount just the I/O modules you need to your DIN rail (or you can panel-mount them). You are not limited by a fixed base size. And you can choose any compatible PC, PLC or other Fieldbus network master.

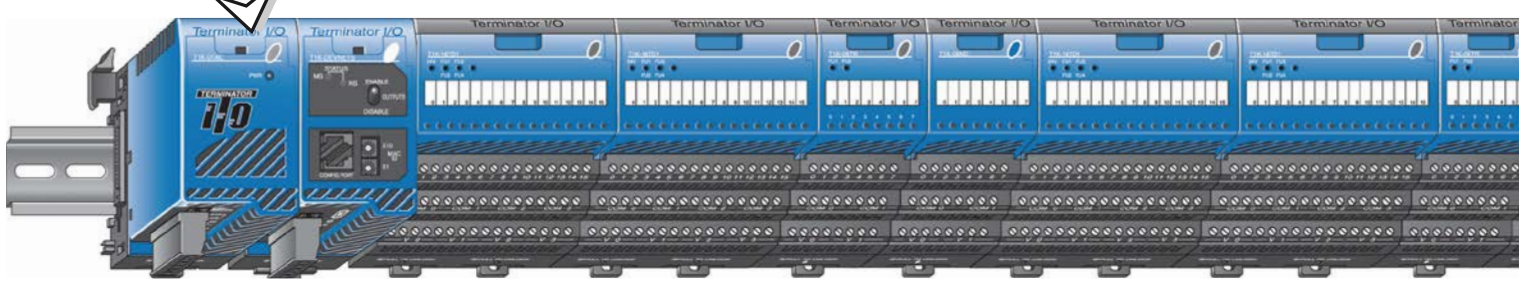
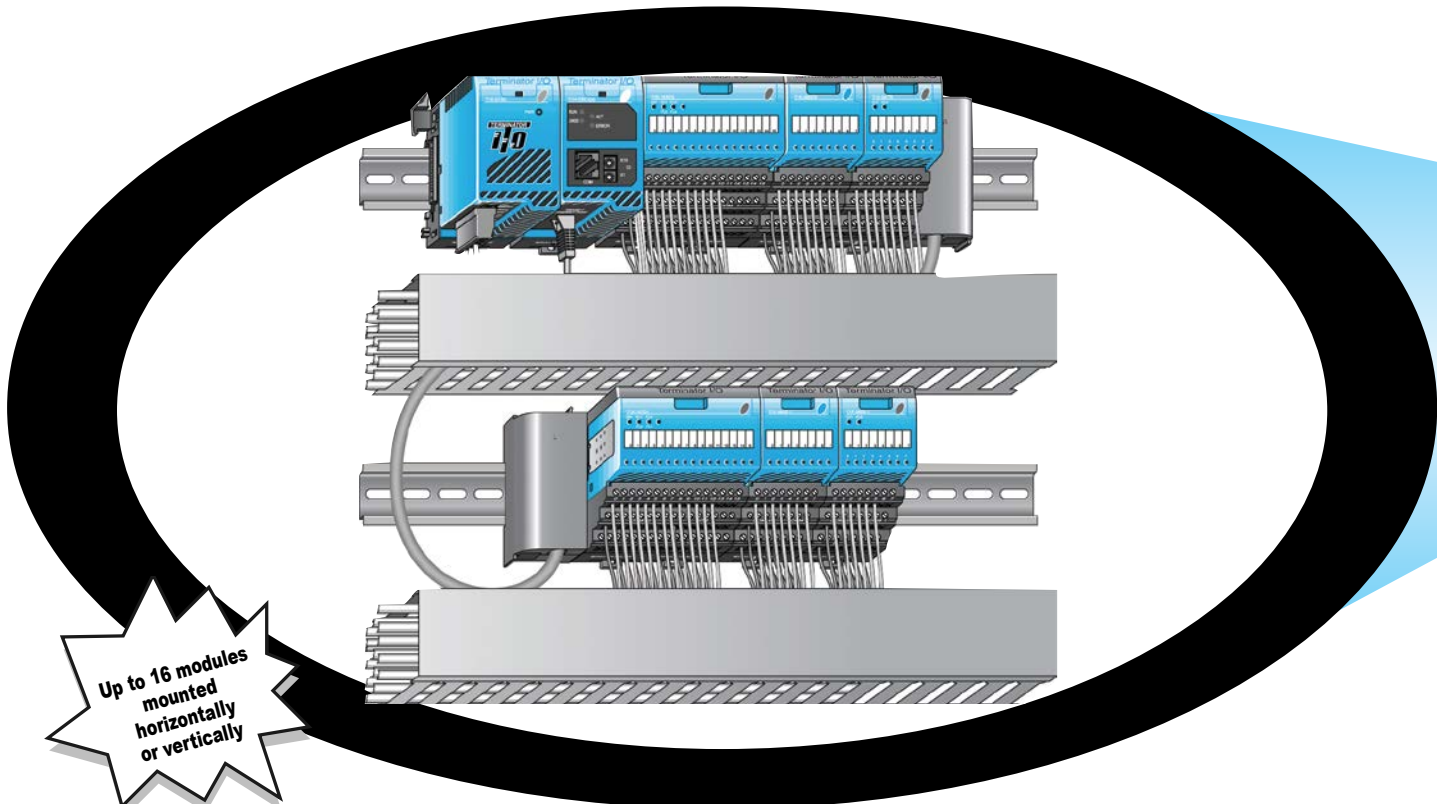

Terminator I/O

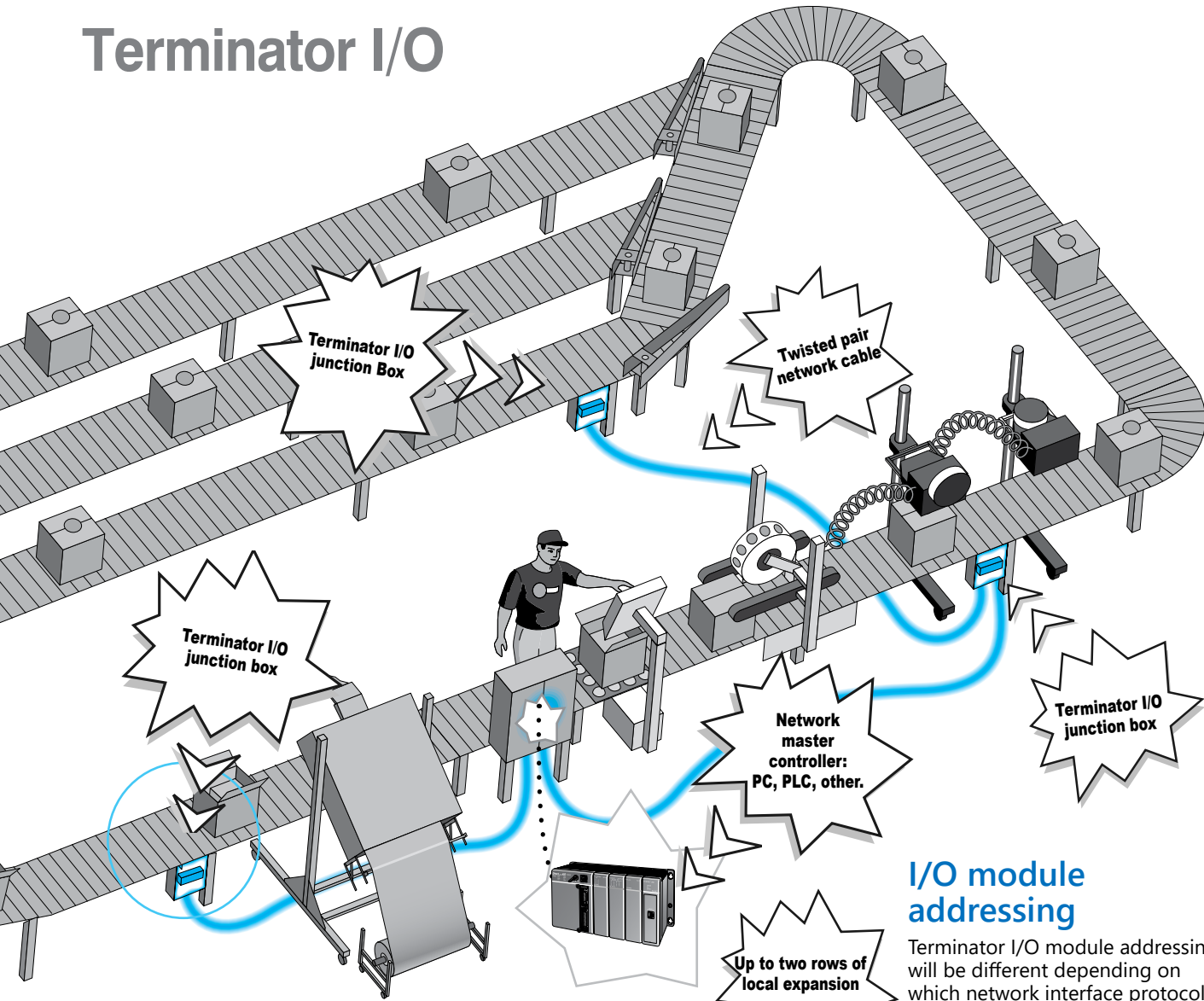

Local expansion

Terminator I/O systems can contain up to 16 modules per node. Each node can be divided into two rows of local expansion (1 network interface base + 2 expansion bases) to accommodate flexible panel space requirements in remote junction boxes. Terminator I/O can be mounted either horizontally or vertically.

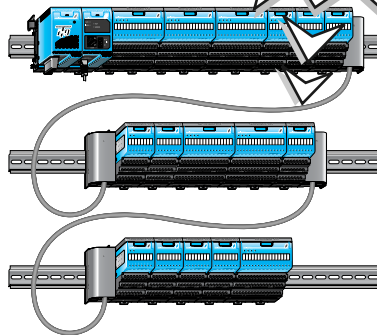

I/O module addressing

Terminator I/O module addressing will be different depending on which network interface protocol is used. For example, DeviceNet™ and PROFIBUS™ support "word" data types for mapping analog modules. For Koyo remote I/O, only discrete ("X" inputs, "Y" outputs) data types are supported, and mapping analog modules is accomplished in blocks of 32 I/O points per channel. Each of the following I/O module specification pages includes an entry for number of I/O points (bits) per module.

Dimensions and Installation

It is important to understand the installation requirements for your Terminator I/O system. This will ensure that the Terminator I/O products work within their environmental and electrical limits.

Plan for safety

This catalog should never be used as a replacement for the technical data sheet that comes with the products or the T1K-INST-M Installation and I/O Manual (available online at www.automationdirect.com.) The technical data sheet contains information that must be followed. The system installation should comply with all appropriate electrical codes and standards.

Unit dimensions and mounting orientation

Use the following diagrams to decide if the Terminator I/O system can be installed in your application. Terminator I/O units should be mounted horizontally. To ensure proper airflow for cooling purposes, units should not be mounted upside-down. It is important to check the Terminator I/O dimensions against the conditions required for your application. For example, it is recommended to leave 2" depth for ease of access and cable clearance. However, your distance may be greater or less. Also, check the installation guidelines for the recommended cabinet clearances.

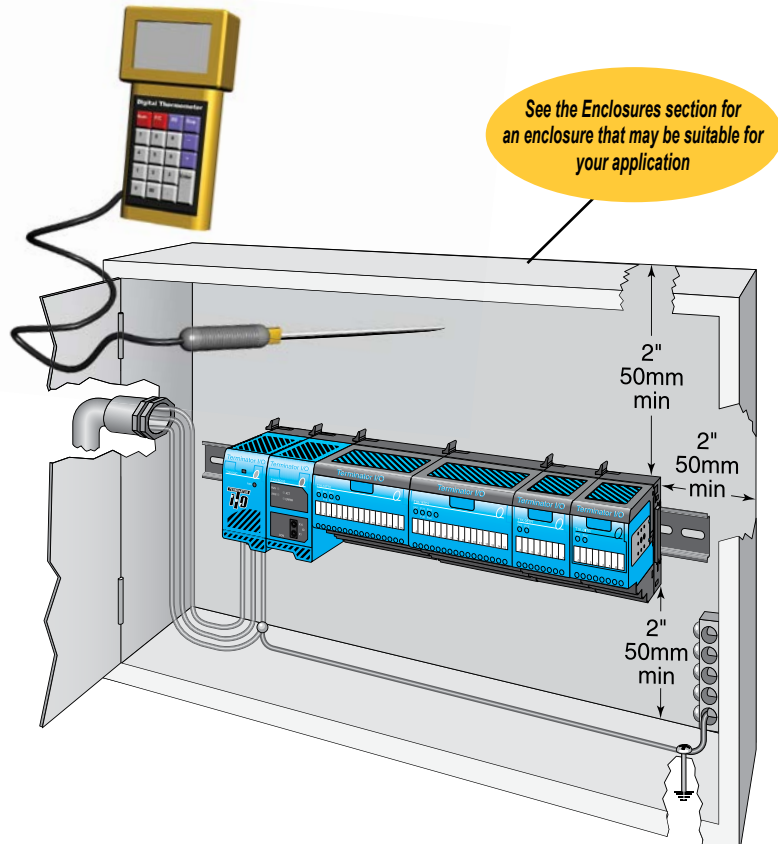

Terminator I/O Environmental Specifications	
Ambient Operating Temperature	32°F to 131°F (0°C to 55°C)
Storage Temperature	-4°F to 158°F (-20°C to 70°C)
Ambient Humidity	5% to 95% (Non-condensing)
Atmosphere	No corrosive gases. The level of environmental pollution = 2 (UL 840)
Vibration Resistance	MIL STD 810C, Method 514.2
Shock Resistance	MIL STD 810C, Method 516.2
Voltage Withstand (Dielectric)	1500VAC, 1 minute
Insulation Resistance	500 VDC, 10 M Ω
Noise Immunity	NEMA ICS3-304 Impulse noise 1 μ s, 1000V FCC class A RFI (144MHz, 430MHz 10W, 10cm)
Agency Approvals	UL, CE, FCC class A, NEC Class 1 Division 2

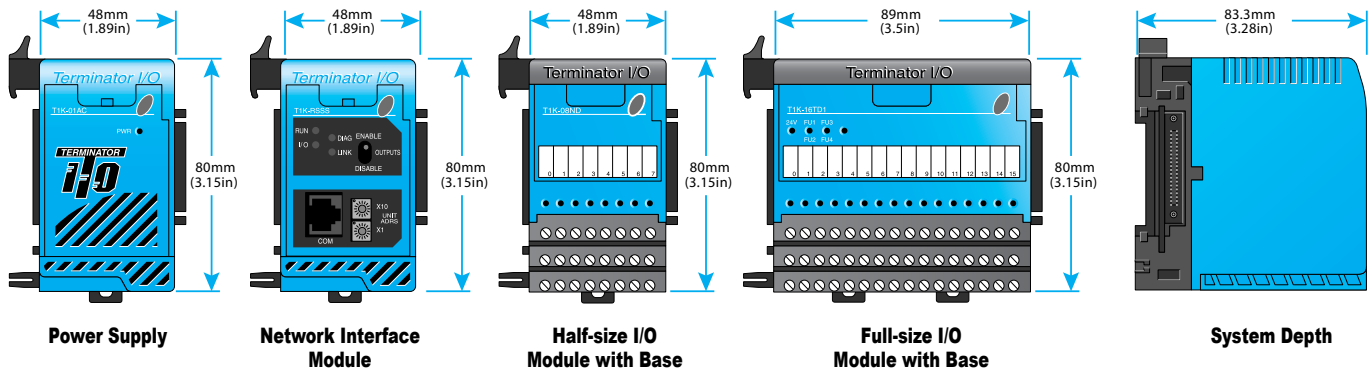

I/O Module Installation

I/O module installation

Terminator I/O modules feature separate terminal bases for easy installation.

To install I/O modules:

1. Slide the module into its terminal base (until it clicks into position)
2. Hook upper DIN rail tabs over the top of DIN rail, and press the assembly firmly onto the DIN rail.
3. Slide the module along the DIN rail until it engages with the adjacent module.

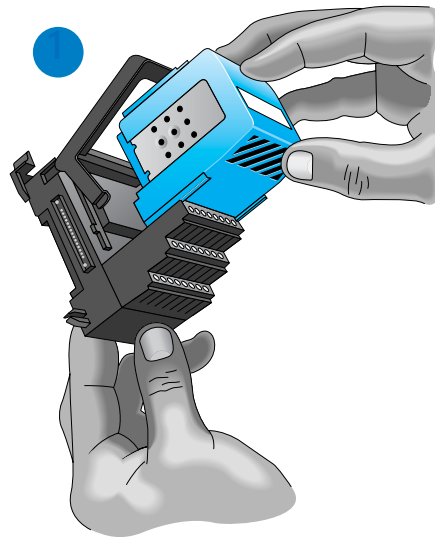

DN-ASB1 angled mounting bracket

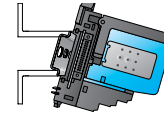

Great for mounting in upper locations

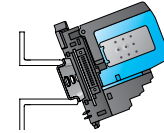

Great for mounting in lower locations

Optional angled support bracket raises and tilts the mounting rail for easier access and wiring. Use with 35mm DIN rail. See the Connection Systems in this catalog for details.

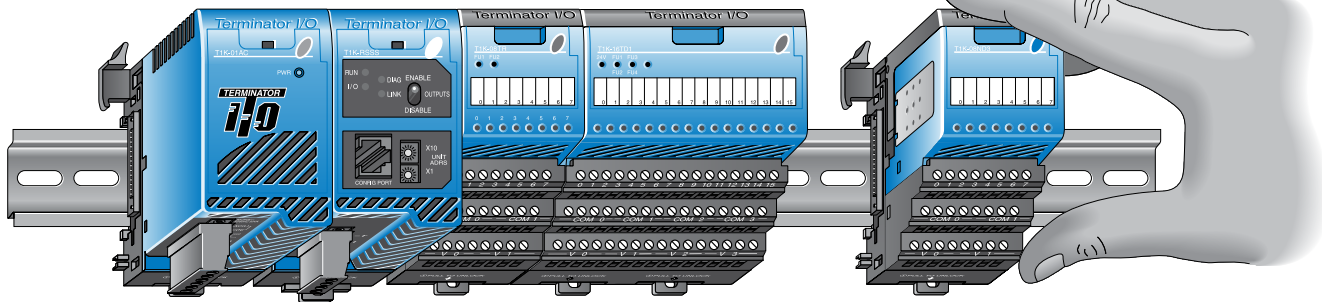
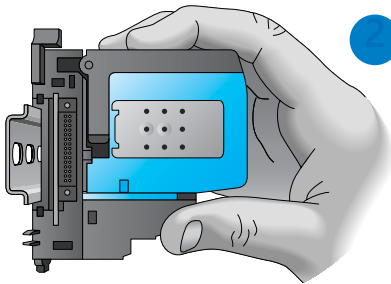

Removing I/O modules is a snap

Grip the locking handle, as shown, and pull gently to eject the I/O module from its base. The module will slide out for easy replacement. This procedure does not apply to network interface modules or power supplies, which have integral bases.

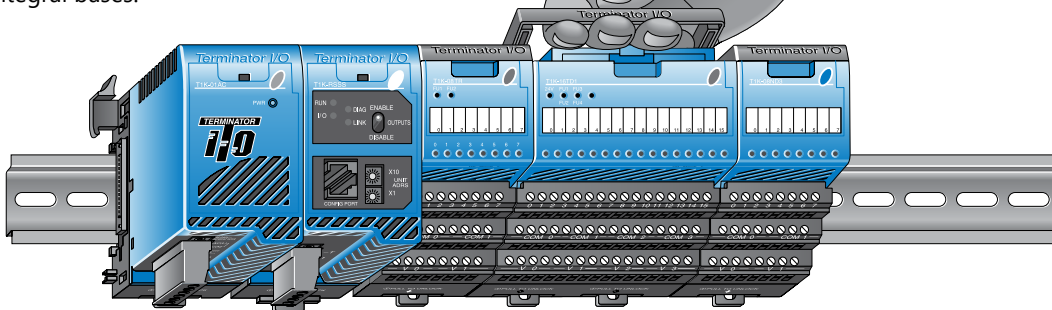
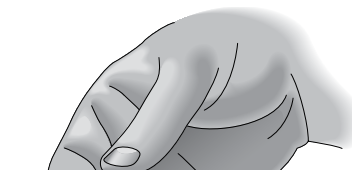

Hot-swappable I/O modules

You can remove I/O modules under power, but exercise caution while doing so. Do not touch the terminals with your hands or any conductive material. Always remove power when possible.

Power Supplies and Power Requirements

Power supplies

The Terminator I/O product line offers two power supply options: AC or DC. The power supplies are always positioned to the left of the modules to which they supply power. Consult the system configuration examples and the power budgeting example for more information on positioning power supplies.

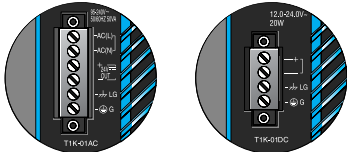

Power supply specifications

Power Supply Specifications		T1K-01AC \$159.00	T1K-01DC \$167.00
Input Voltage Range		110/220 VAC	12/24 VDC
Input Frequency		50/60 Hz	N/A
Maximum Power		50VA	30W
Max. Inrush Current		20A	10A
Insulation Resistance		> 10M Ω @ 500 VDC	
Voltage Withstand		1 min. @ 1500VAC between primary, secondary and field ground	
5VDC PWR	Voltage	5.25 VDC	5.25 VDC
	Current Rating	2000 mA max (see current option note below)	2000mA max
	Ripple	5% max.	5% max.
24VDC PWR	Voltage	24VDC	N/A
	Current Rating	300mA max. (see current option note below)	N/A
	Ripple	10% max.	N/A
Fuse	1 (primary), not replaceable		
Replacement Terminal Block (Phoenix Contact)	MVSTBW 2.5/4-ST- 5.08 BK	MVSTBW 2.5/6-ST- 5.08 BK	
Note: 500mA @ 24VDC can be achieved by lowering the 5VDC from 2000mA to 1500mA.			

Power requirements

Module	5VDC	24VDC	Module	5VDC	24VDC	Module	5VDC	24VDC		
Interface Modules			DC Output Modules			Analog Input Modules				
T1H-EBC100	300	0	T1H-08TDS	200	0	T1F-08AD-1	75	50*		
T1K-DEVNETS	250	45	T1K-08TD1	100	200*	T1F-08AD-2	75	50*		
T1K-MODBUS	300	0	T1K-16TD1	200	400*	T1F-16AD-1	75	50*		
DC Input Modules			T1K-08TD2-1	200	0	T1F-16AD-2	75	50*		
T1K-08ND3	35	0	T1K-16TD2-1	200	0	T1F-16RTD	150	0		
T1K-16ND3	70	0	AC Output Modules			T1F-16TMST	150	0		
AC Input Modules			T1K-08TA			250	0	T1F-14THM	60	70*
T1K-08NA-1	35	0	T1K-16TA			450	0	Analog Output Modules		
T1K-16NA-1	70	0	T1K-08TAS			300	0	T1F-08DA-1	75	150*
			Relay Output Modules			T1F-08DA-2			75	150*
			T1K-08TR			350	0	T1F-16DA-1	75	150*
			T1K-16TR			700	0	T1F-16DA-2	75	150*
			T1K-08TRS			400	0	Combination Analog Modules		
			Specialty Modules			T1F-8AD4DA-1			75	60*
			T1H-CTRIO			400	0	T1F-8AD4DA-2	75	70*
			* Use either internal or external source for 24VDC						* Use either internal or external source for 24VDC	

Calculating the power budget

To calculate the power budget, read the available power (current rating) from the Power Supply Specifications table and subtract the power consumed by each module to the right of the power supply. Do not include modules to the right of an additional power supply.

Adding additional power supplies

Each power supply furnishes power only to the network interface and I/O modules to its right. Inserting a second power supply closes the power loop for the power supply to the left, while also powering the modules to its right. Perform a power budget calculation for each power supply in the system.

Power Budget Example		
Module	5VDC	24VDC
T1K-01AC	+2000mA	+300mA
T1H-EBC100	-300mA	-0mA
T1K-16ND3	-70mA	-0mA
T1K-16TD2	-200mA	-0mA
T1F-08AD-1	-75mA	-50mA
Remaining	+1355mA	+250mA

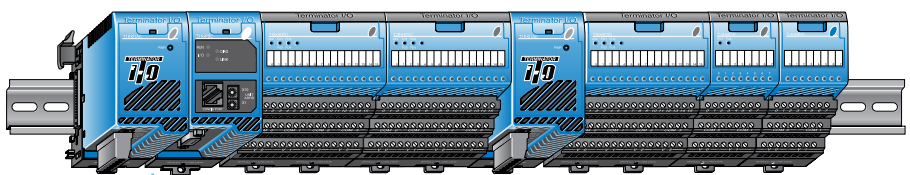

This power supply powers the network interface module and the next two I/O modules

This power supply powers these three I/O modules

Expansion I/O Configurations

Expansion cables

<u>T1K-10CBL</u>	\$104.00
<u>T1K-10CBL-1*</u>	\$138.00

Right side to left side expansion cable

The T1K-10CBL(-1) connects the right side of an I/O base to the left side of the next I/O base. A maximum of two T1K-10CBL(-1) cables can be used per expansion system.



*Note: The (-1) versions of the expansion cables pass 24VDC through on an isolated wire. (All cables pass the 5VDC base power.) Any local expansion DC input module configured for "internal power" (current sourcing) must either have a power supply preceding it on the same base or, have a (-1) version cable pass 24VDC from a power supply on the preceding base.

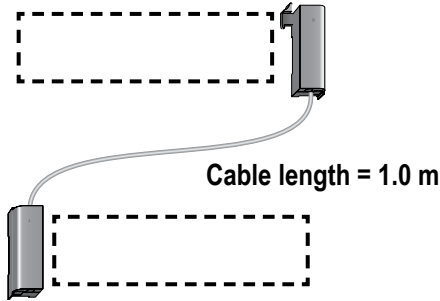

Using two T1K-10CBL expansion cables

In the system below, power supplies can be used anywhere.

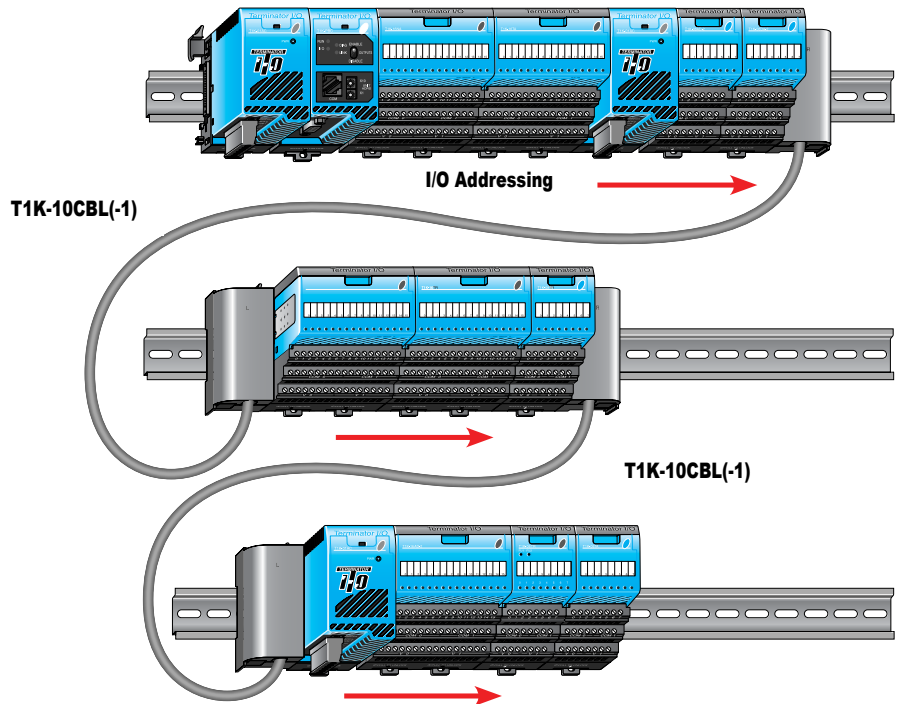

Field Device Wiring and Power Options

Terminal base specifications

Terminator I/O terminal bases are available in screw clamp and spring clamp versions for both half-size and full-size modules. Hot stamp silk screen labeling is used for numbering I/O points, commons, and all power terminals.

Terminal Base Specifications		
Terminal Type	Screw type	Spring clamp
Recommended Torque	1.77–3.54 lb-in (0.2–0.4 N·m)	N/A
Wire Gauge	Solid: 25–12 AWG	Solid: 25–14 AWG
	Stranded: 26–12 AWG	Stranded: 26–14 AWG

Field device wiring options

Power your DC input devices from the integrated 24VDC power supply bus. T1K-08ND3 and T1K-16ND3 DC input modules include jumpers for selecting the internal 24VDC power supply available for 2- and 3-wire field devices. Clearly labeled triple stack terminals make it easy to wire 2- and 3-wire devices ensuring clean wiring with only one wire per termination.

External user supplied 24VDC power, or auxiliary 24VDC terminals from T1K-01AC, can be easily applied directly to one end of the terminal rows and jumpered across each base in the system.

This is a convenient solution for powering analog I/O and discrete DC output devices whose modules do not have direct access to the internal bussed 24VDC. If current consumption increases, simply add additional T1K-01AC power supplies into the system.

T1K-08B \$119.00

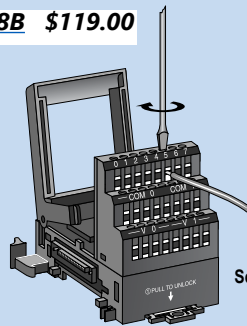

Screw clamp, half-size

T1K-08B-1 \$129.00

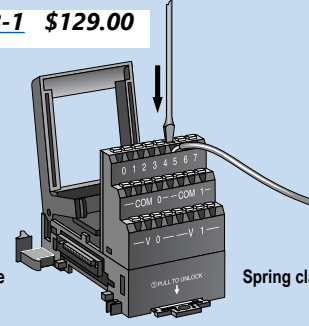

Spring clamp, half-size

T1K-16B \$152.00

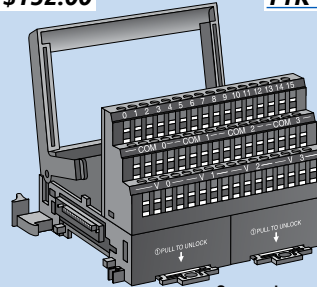

Screw clamp, full-size

T1K-16B-1 \$155.00

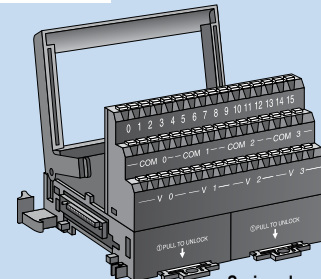

Spring clamp, full-size

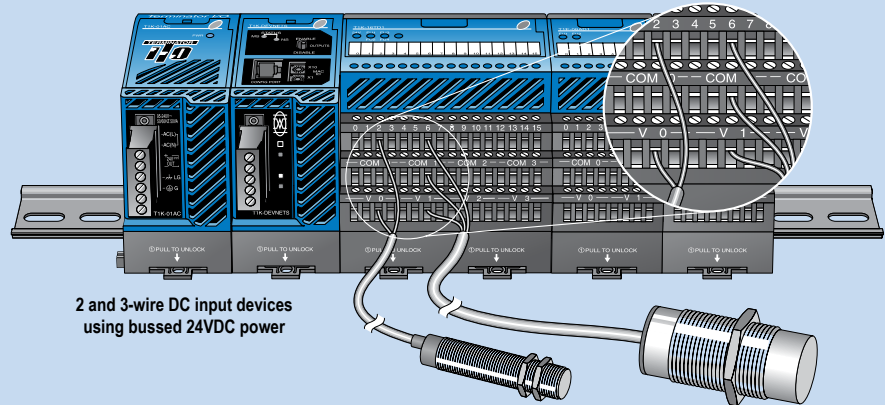

2 and 3-wire DC input devices using bussed 24VDC power

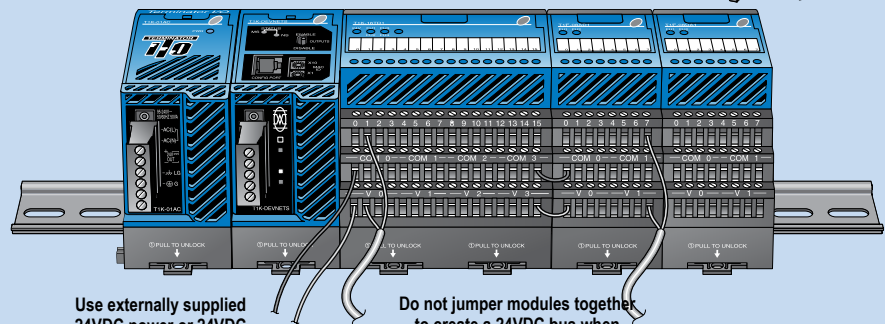

Use externally supplied 24VDC power or 24VDC auxiliary power from T1K-01AC

Do not jumper modules together to create a 24VDC bus when using the "hot swap" feature. See Note below.

Hot-swap feature

The hot-swap feature allows Terminator I/O modules to be replaced while system power is on. Be careful not to touch the terminals with your hands or other conductive material to avoid the risk of personal injury or equipment damage. Always remove power if it is equally convenient to do so.

Note: Before hot-swapping analog or

DC output modules in a Terminator I/O system, make sure that each of the analog and DC output module's 24VDC and 0 VDC base terminals are wired directly to the external power supply individually. If the external 24VDC and 0 VDC is jumpered from base to base in a daisy chain fashion, and an analog or DC output

module is removed from its base, the risk of disconnecting the external 24VDC and 0 VDC to the subsequent I/O modules exists.